

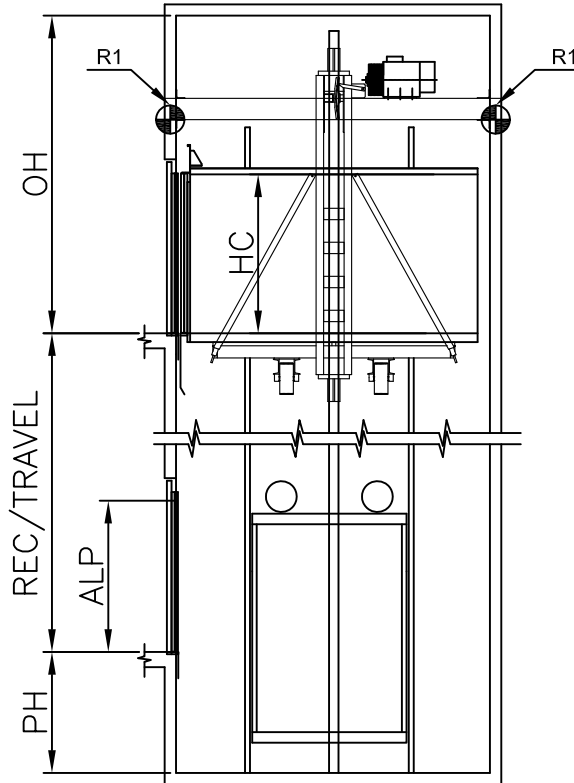

ESCALA/SCALE 1:100

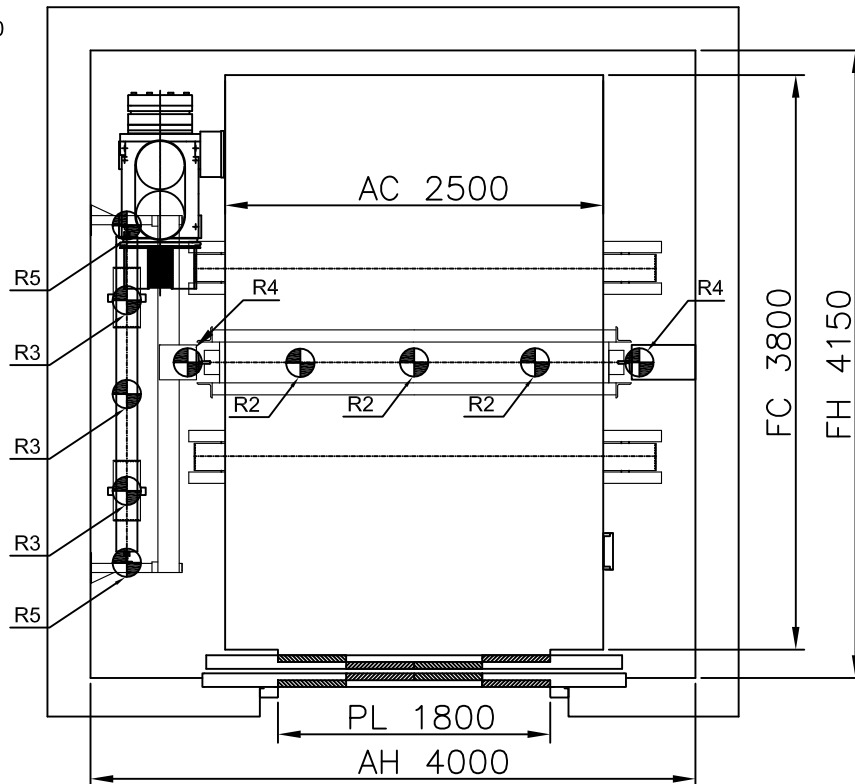

ESCALA/SCALE 1:50



ACCIONES SOBRE EL HUECO / SHAFT REACTIONS

R1	CARGA SOBRE PARED / WALL LOAD	105000 N
R2	CARGA EN PUFFER CAB / CAR BUFFER LOAD	140000 N
R3	CARGA EN PUFFER CPSO / CTW BUFFER LOAD	103333 N
R4	CARGA EN GUÍA CAB / CAR GUIDE LOAD	102900 N
R5	CARGA EN GUÍA CPSO / CTW GUIDE LOAD	1650 N
	REACCION DE GUIAS Sx / GUIDES REACTIONS Sx	10292 N
	REACCION DE GUIAS Sy / GUIDES REACTIONS Sy	7835 N

MP7305 GO! "S"

5500 Kg

0.5 m/s

73 P.

GO!

1600

4200

FOSO/PIT

HUIDA/OVERHEAD



30 Kw