

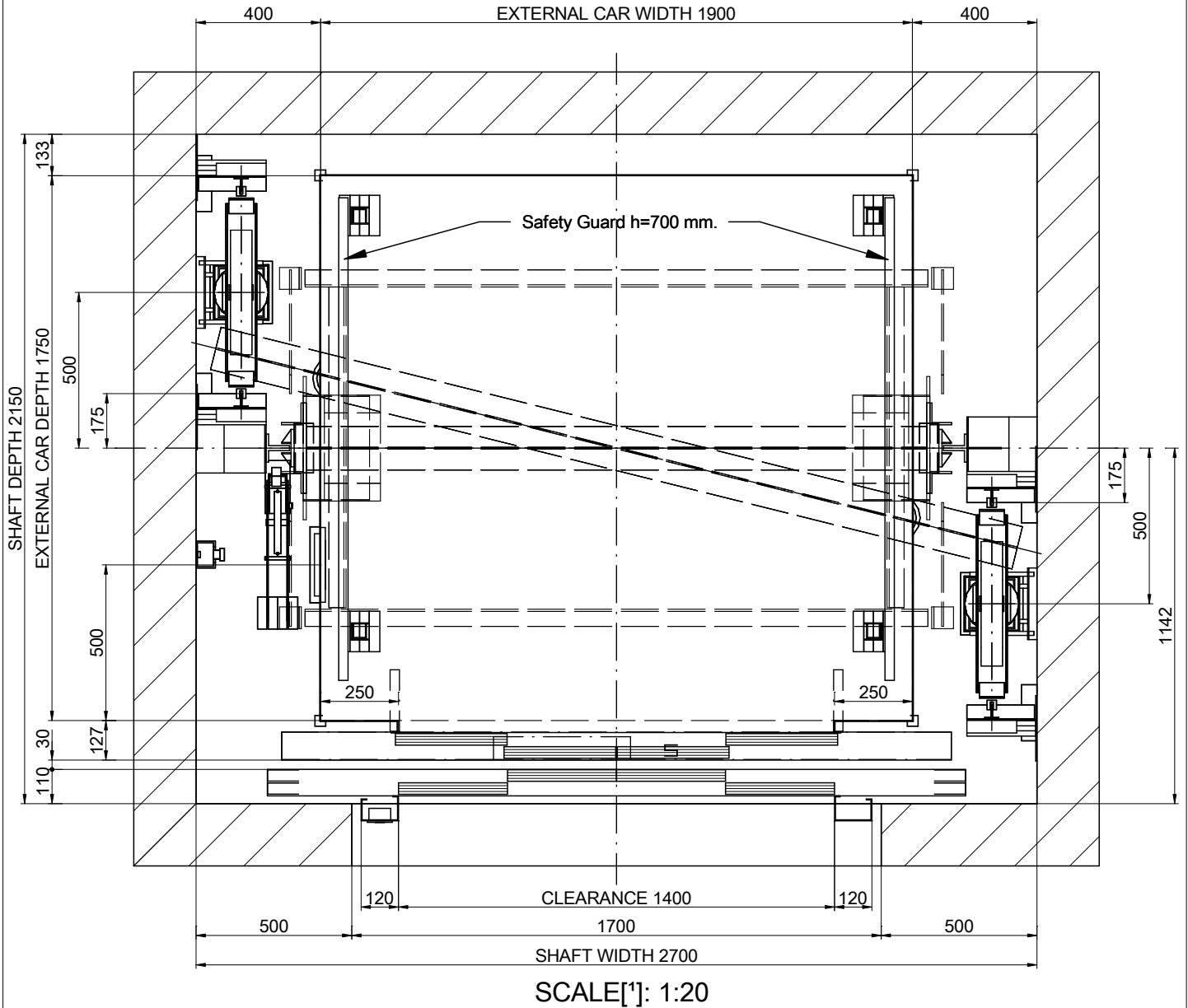

01-PLAN VIEW



DRAWING	DATE	REV.	SHEET	[*] Unbounded dimensions in drawings are indicative and not binding. REFERENCE: MPH_MONTACARGAS_1500_EN	
MP	2017	00	1/8		
MODEL LIFT:				CLIENT:	WORK SITUATION:
MP H					
CAPACITY: [N° PERSONS]			20	<h2>MP LIFTS</h2>	
NOMINAL LOAD: [kg]			1500		
SPEED: [m/s]			0.5		
FREQUENCY: [Hz]			50		
TENSION: [V]			380V [Three-phase]		

01B-PLAN VIEW

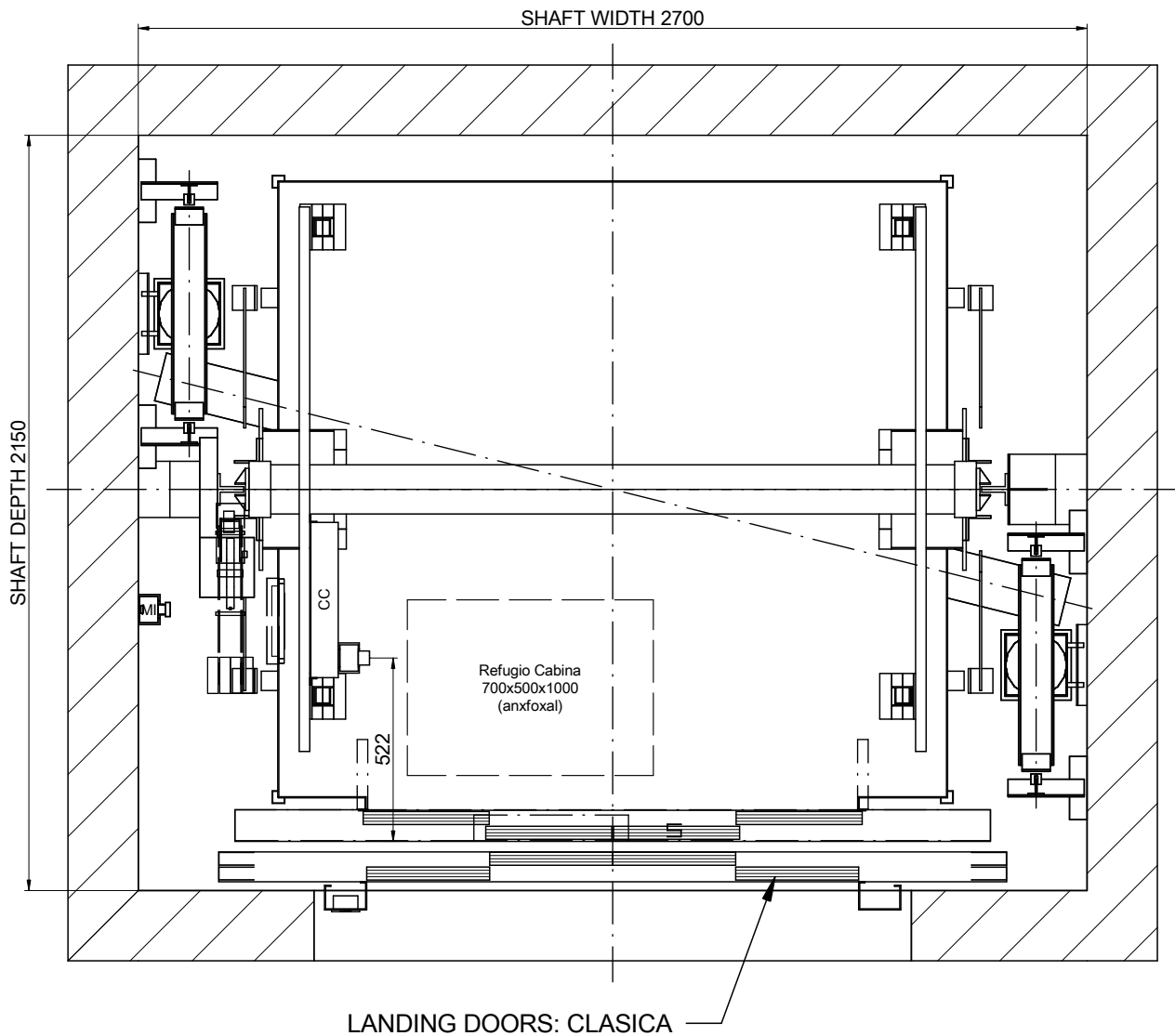

SCALE[*]: 1:20

NOMENCLATURE

CC: Car ceiling connection box

MI: Inspection control station

DRAWING	DATE	REV.	SHEET	[*] Unbounded dimensions in drawings are indicative and not binding.	
MP	2017	00	2/8	REFERENCE: MPH_MONTACARGAS_1500_EN	
MODEL LIFT:				CLIENT:	WORK SITUATION:
MP H					
CAPACITY: [N° PERSONS]			20	<h2>MP LIFTS</h2>	
NOMINAL LOAD: [kg]			1500		
SPEED: [m/s]			0.5		
FREQUENCY: [Hz]			50		
TENSION: [V]		380V [Three-phase]			

02-SIDE VERTICAL SECTION

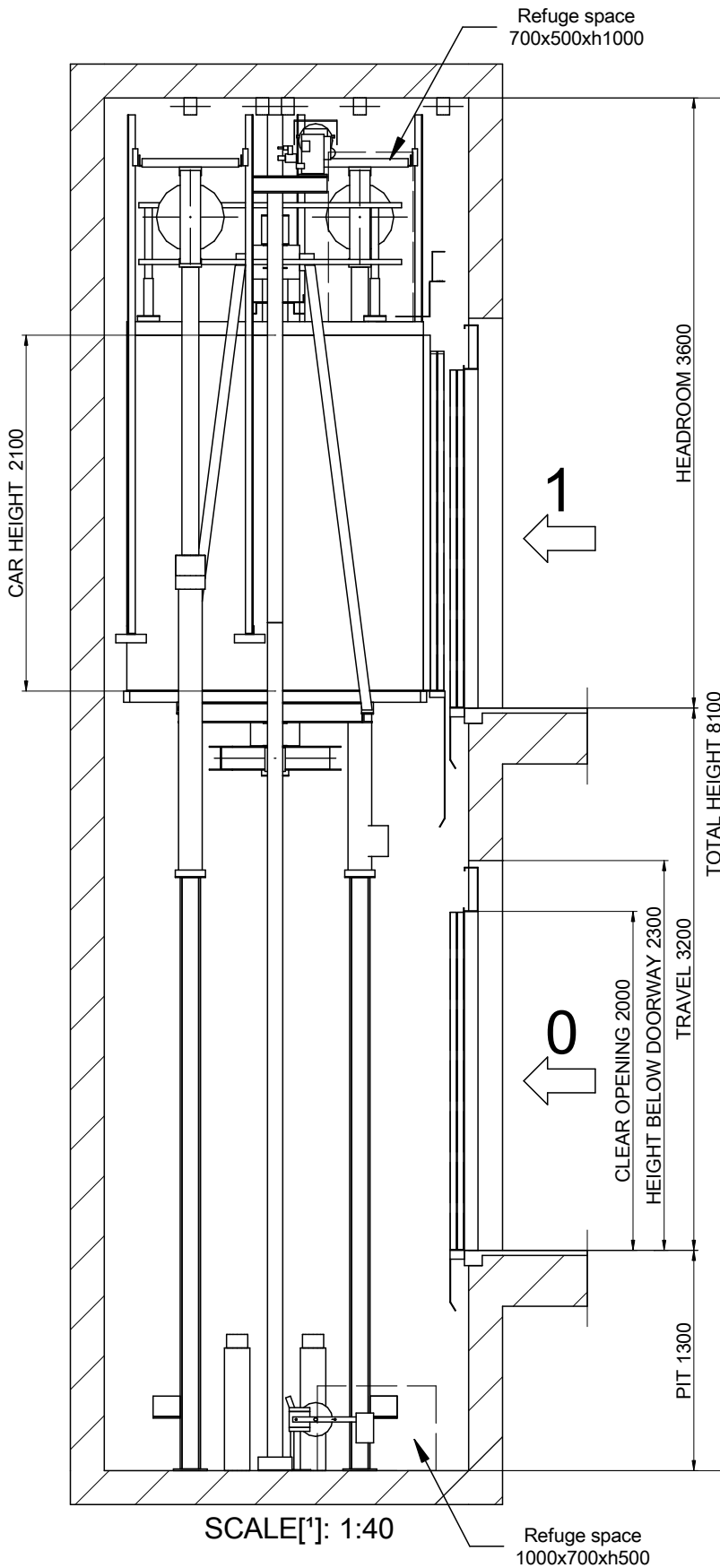

DRAWING		DATE	REV.	SHEET	[1] Unbounded dimensions in drawings are indicative and not binding.
MP	2017	00	3/8	REFERENCE: MPH_MONTACARGAS_1500_EN	
MODEL LIFT:		MP H			CLIENT: WORK SITUATION:
CAPACITY: [N° PERSONS]		20			MP LIFTS
NOMINAL LOAD: [kg]		1500			
SPEED: [m/s]		0.5			
FREQUENCY: [Hz]		50			
TENSION: [V]		380V [Three-phase]			

Flat and levelled floor, protected against water leaking.
[EN81-20:2014 5.2.1.9]
Foresee pit access device
[EN81-20:2014 5.2.2.4]
Stop device
[EN81-20:2014 5.2.1.5.1. a]
Inspection control station.
[EN81-20:2014 5.2.1.5.1. b]
Power supply
[EN81-20:2014 5.2.1.5.1. c]
Light switch commuted with the cabinet.
[EN81-20:2014 5.2.1.5.1. d]

MAX DISTANCE BETWEEN BRACKETS = 1500 mm

04-BEAM AND LIFTING HOOKS

POSITION OF REMOVABLE LIFTING HOOKS ABLE TO SUPPORT
2000 kg EACH ONE SUPPLIED BY CONSTRUCTOR
(RECOMMENDED POSITION LOADHOOKS)

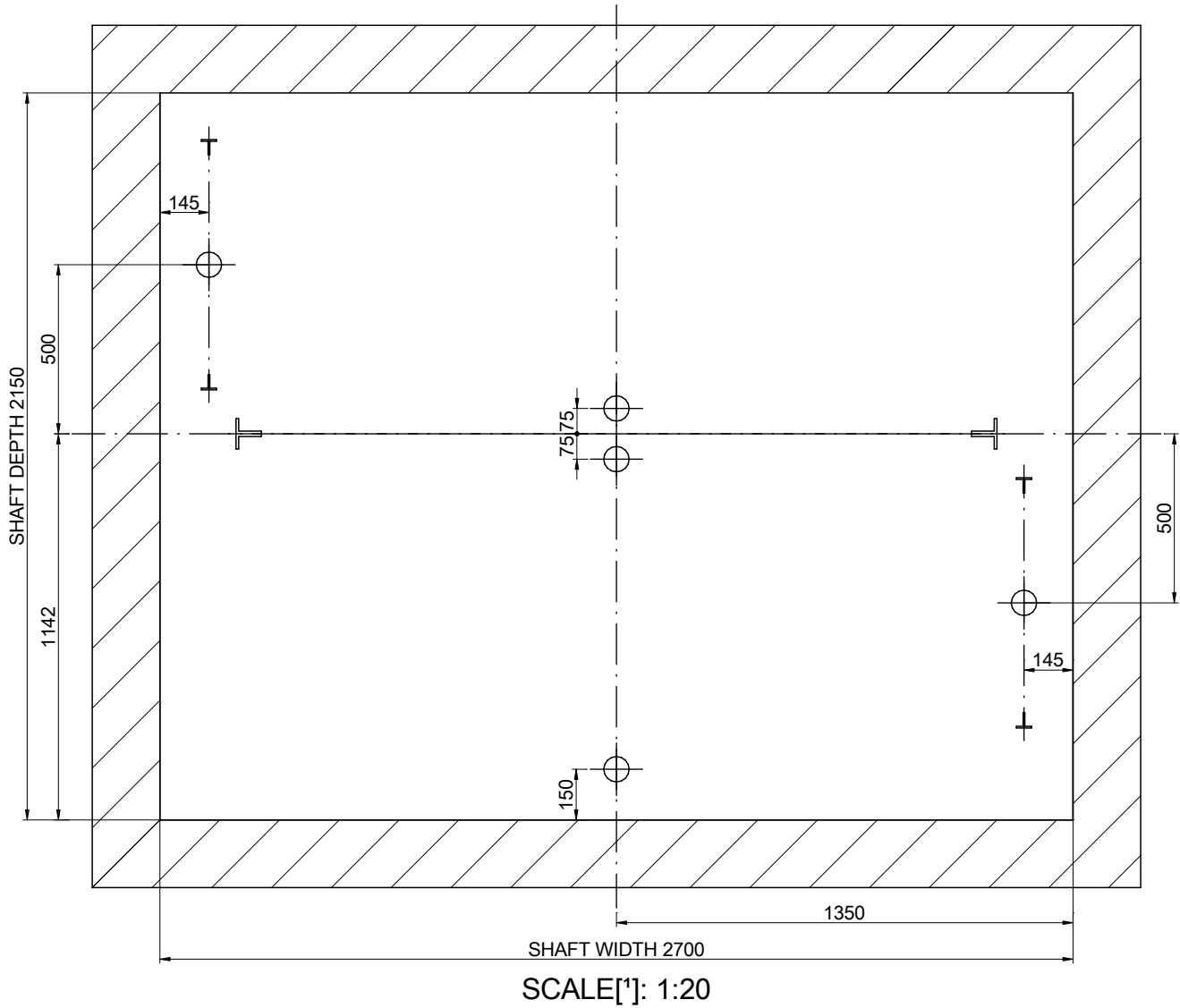

DRAWING	DATE	REV.	SHEET	[*] Unbounded dimensions in drawings are indicative and not binding.	
MP	2017	00	4/8	REFERENCE: MPH_MONTACARGAS_1500_EN	
MODEL LIFT:				CLIENT:	WORK SITUATION:
MP H					
CAPACITY: [N° PERSONS]			20	<h2>MP LIFTS</h2>	
NOMINAL LOAD: [kg]			1500		
SPEED: [m/s]			0.5		
FREQUENCY: [Hz]			50		
TENSION: [V]			380V [Three-phase]		

04B-MACHINE ROOM

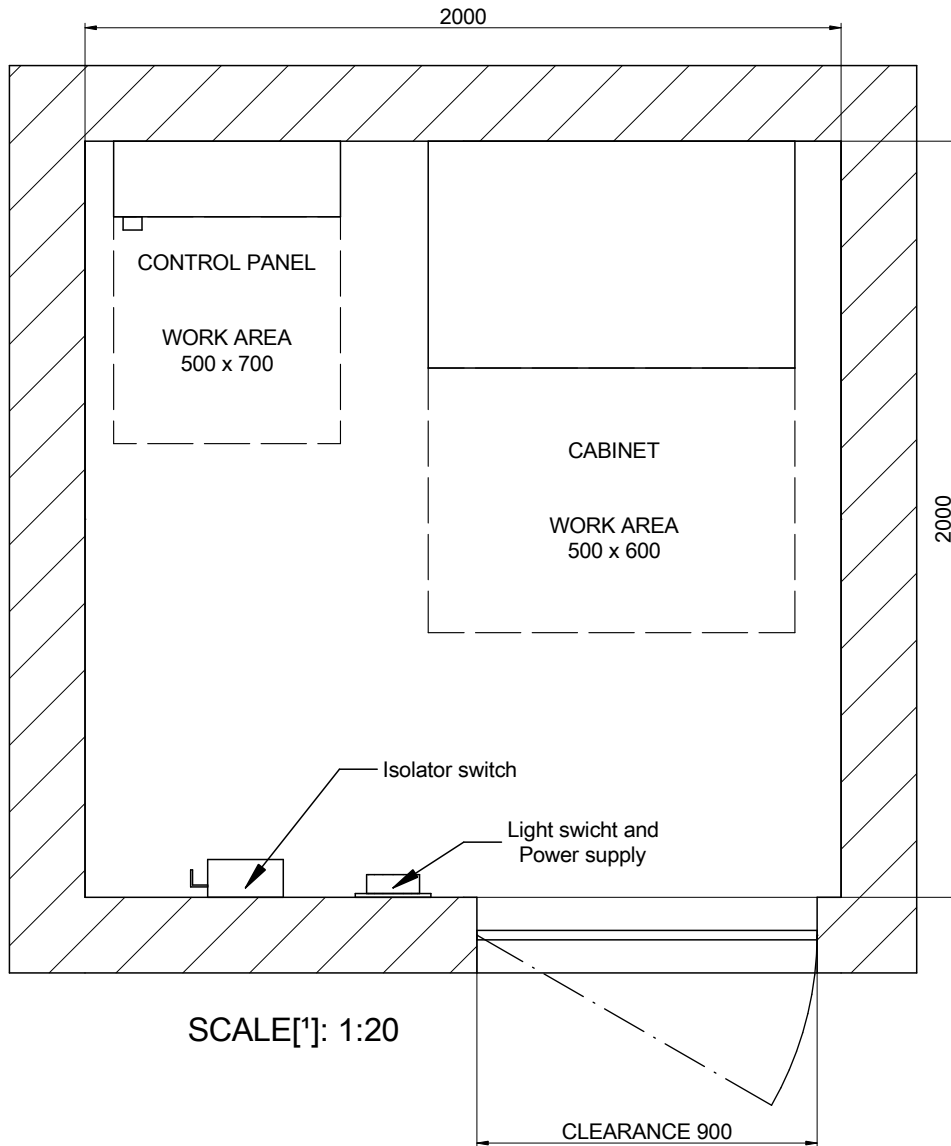

Minimum machine room height: 2100 mm.
[EN 81-20:2014 5.2.6.3.2.1]
Minimum clearance door: 600x2000 mm.
[EN 81-20:2014 5.2.3.2 a)]

Machine room location:
Machine room located in floor level:
[3] Distance controller/shaft:
Cylinder oil entrance location: 0

DRAWING	DATE	REV.	SHEET	[*] Unbounded dimensions in drawings are indicative and not binding.	
MP	2017	00	5/8	REFERENCE: MPH_MONTACARGAS_1500_EN	
MODEL LIFT:				CLIENT: WORK SITUATION:	<p style="text-align: center; font-size: 2em; font-weight: bold;">MP LIFTS</p>
MP H					
CAPACITY: [N° PERSONS]		20			
NOMINAL LOAD: [kg]		1500			
SPEED: [m/s]		0.5			
FREQUENCY: [Hz]		50			
TENSION: [V]		380V [Three-phase]			

05-PIT LAYOUT

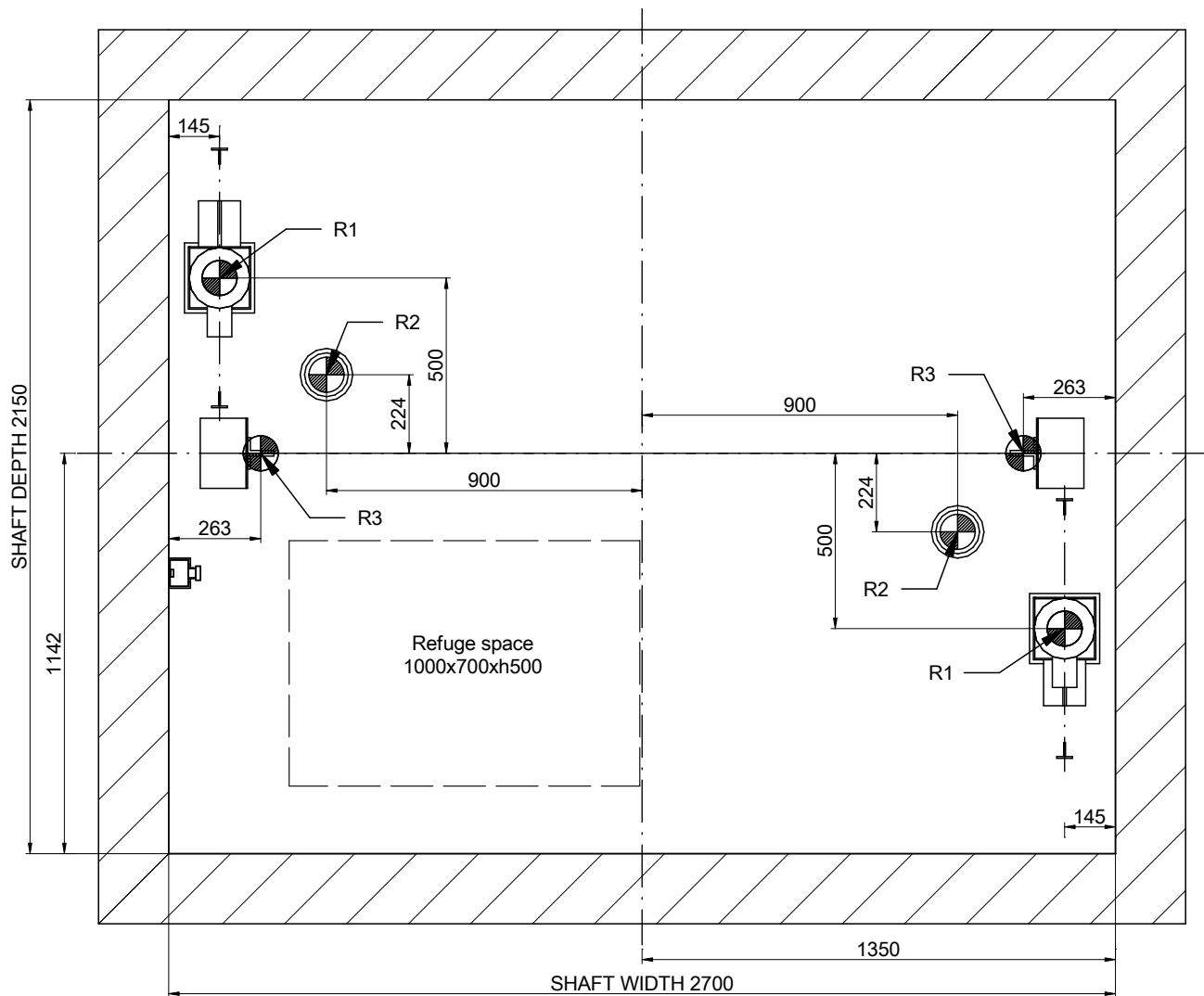

SCALE[*]: 1:20

REACTIONS [N] [max.]			
R1	41500	R2	60000
R3	43000		
Sx	2000	Sy	500

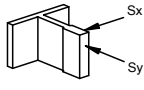

DRAWING	DATE	REV.	SHEET	[*] Unbounded dimensions in drawings are indicative and not binding.	
MP	2017	00	6/8	REFERENCE: MPH_MONTACARGAS_1500_EN	
MODEL LIFT:				CLIENT:	WORK SITUATION:
MP H					
CAPACITY: [N° PERSONS]			20	<h2>MP LIFTS</h2>	
NOMINAL LOAD: [kg]			1500		
SPEED: [m/s]			0.5		
FREQUENCY: [Hz]			50		
TENSION: [V]			380V [Three-phase]		

06-DOOR HOLE DETAIL

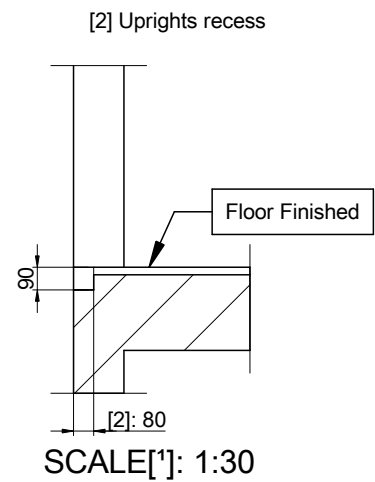
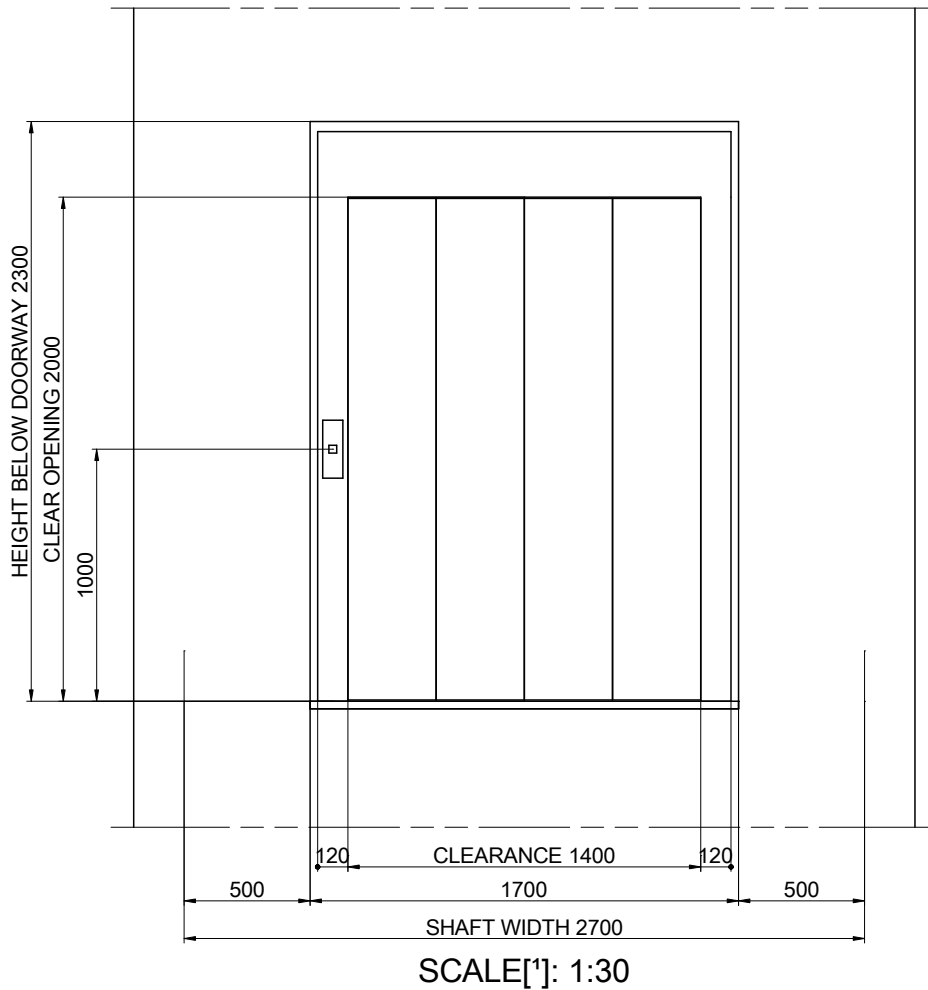

DRAWING	DATE	REV.	SHEET	[*] Unbounded dimensions in drawings are indicative and not binding.	
MP	2017	00	7/8	REFERENCE: MPH_MONTACARGAS_1500_EN	
MODEL LIFT:				CLIENT:	WORK SITUATION:
MP H					
CAPACITY: [N° PERSONS]			20	<h2>MP LIFTS</h2>	
NOMINAL LOAD: [kg]			1500		
SPEED: [m/s]			0.5		
FREQUENCY: [Hz]			50		
TENSION: [V]			380V [Three-phase]		

07-HEADROOM

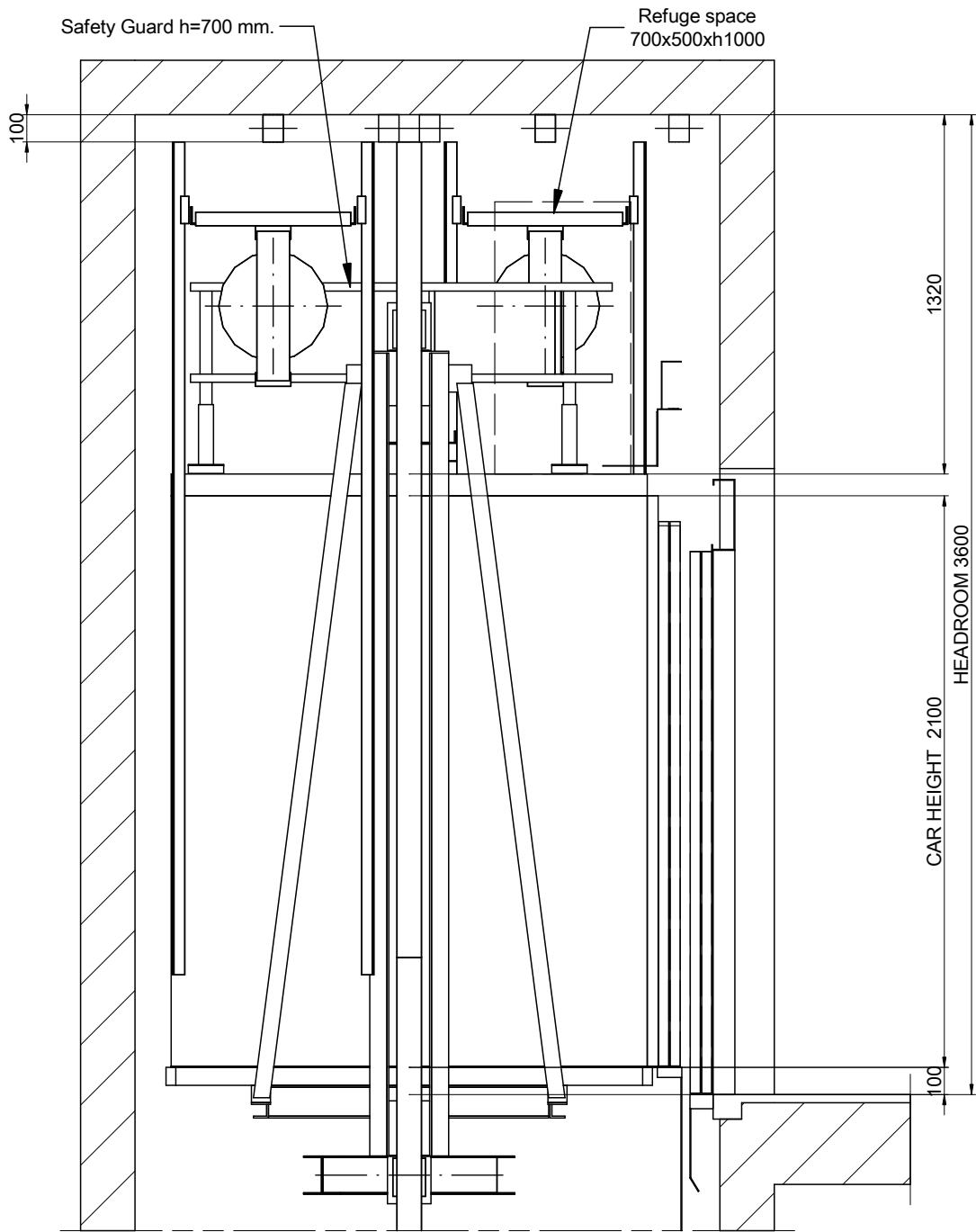

SCALE[*]: 1:25

DRAWING	DATE	REV.	SHEET	[*] Unbounded dimensions in drawings are indicative and not binding. REFERENCE: MPH_MONTACARGAS_1500_EN	
MP	2017	00	8/8		
MODEL LIFT:				CLIENT:	WORK SITUATION:
MP H					
CAPACITY: [N° PERSONS]		20		MP LIFTS	
NOMINAL LOAD: [kg]		1500			
SPEED: [m/s]		0.5			
FREQUENCY: [Hz]		50			
TENSION: [V]		380V [Three-phase]			