

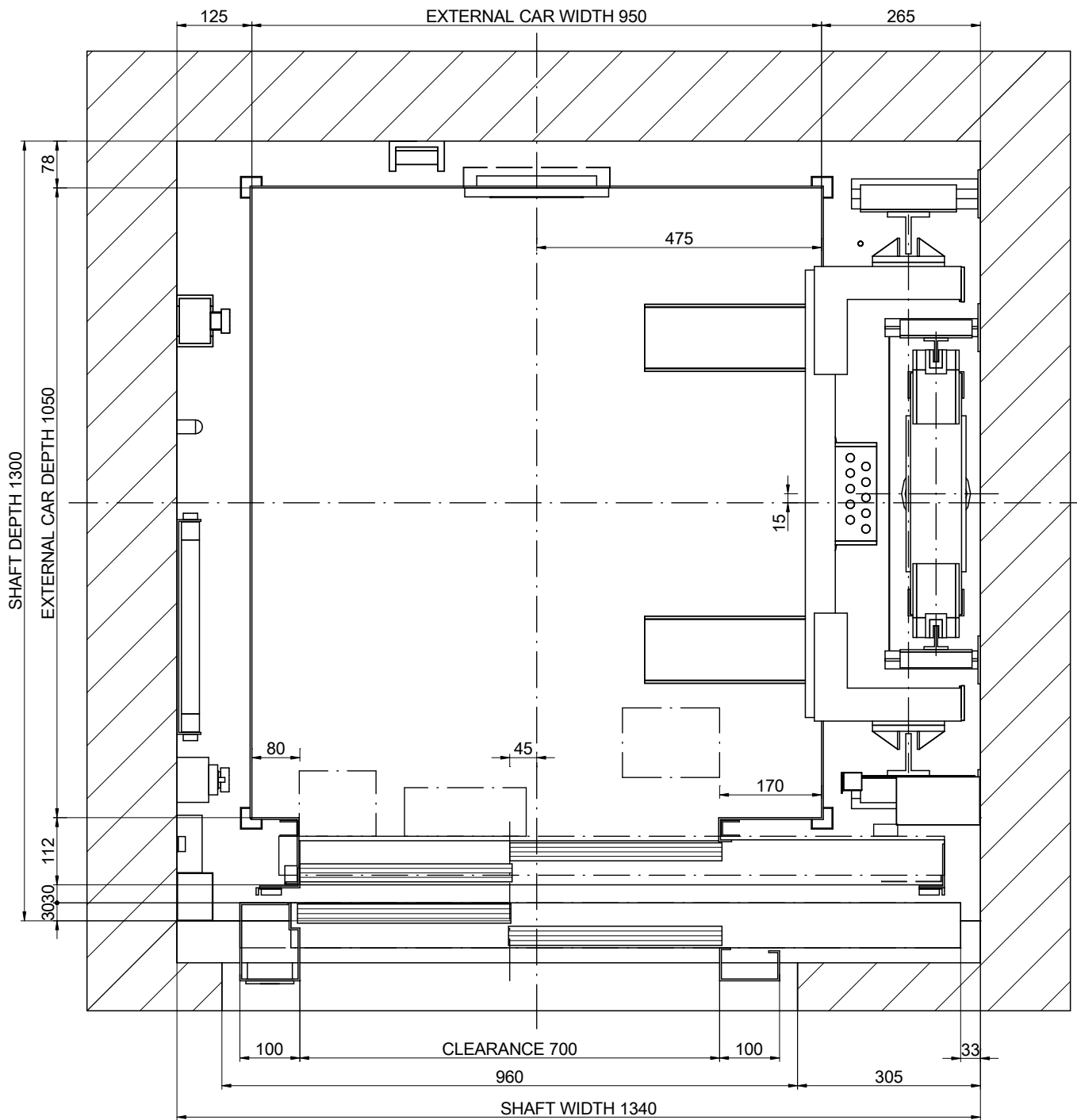

01-PLAN VIEW



SCALE[*]: 1:10

DRAWING	DATE	REV.	SHEET	[*] Unbounded dimensions in drawings are indicative and not binding. REFERENCE: MPGOIFLEXLLATERAL375S_EN	
MP	2016	00	1/8		
MODEL LIFT:				CLIENT:	WORK SITUATION:
MP GO! FLEX XL					
CAPACITY: [N° PERSONS]			5	<h2>MP LIFTS</h2>	
NOMINAL LOAD: [kg]			375		
SPEED: [m/s]			1		
FREQUENCY: [Hz]			50		
TENSION: [V]			380V [Three-phase]		

01B-PLAN VIEW

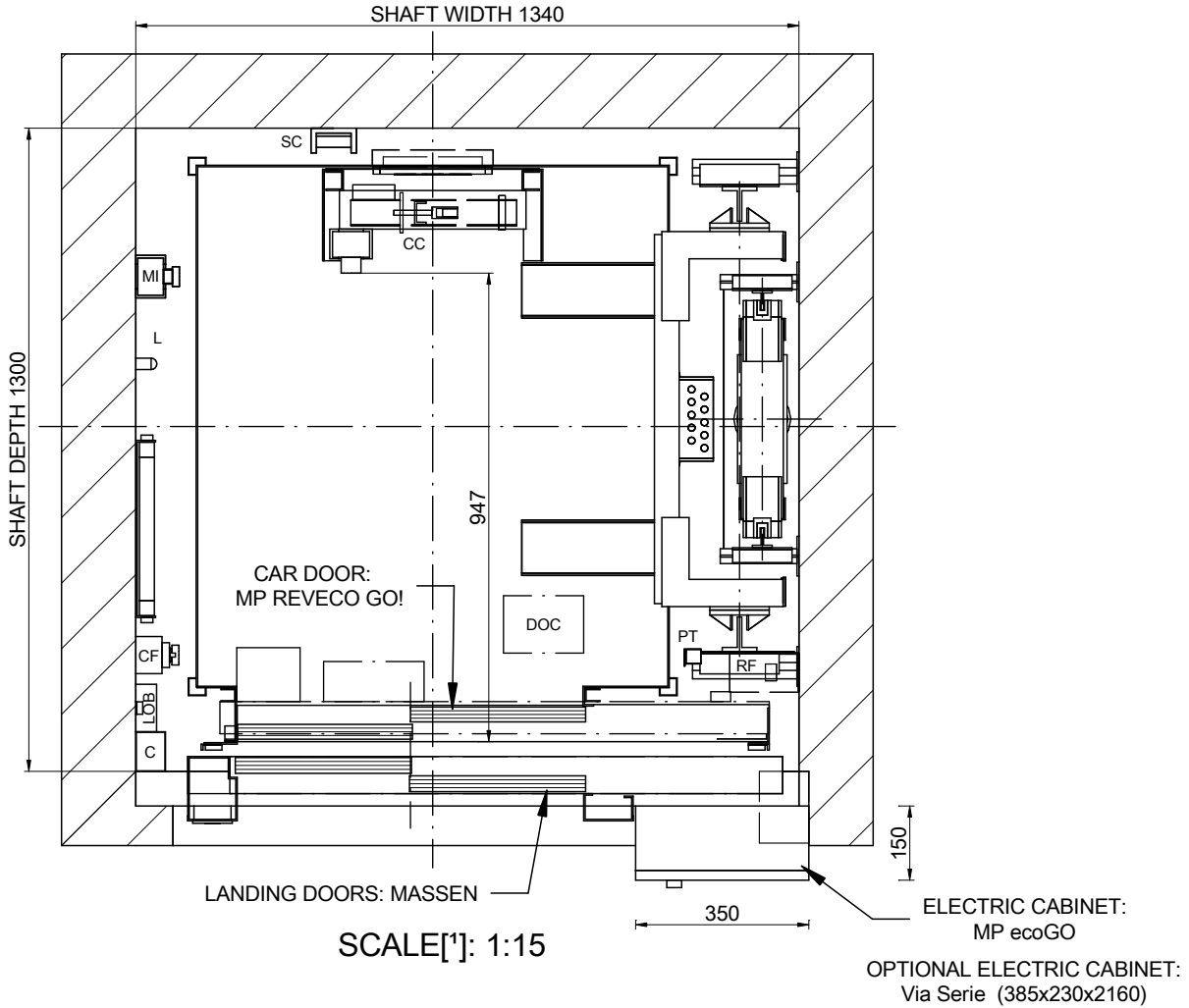

NOMENCLATURE

- C: Wiring channel
- CC: Car ceiling connection box
- CF: Pit box
- CL: Shaft light switch
- DOC: Operator control box
- L: Lamp
- LOB: Pushbutton control board
- MI: Inspection control station
- PT: Fixed cam
- RF: Brake resistor
- ST: Stopping device
- SC: Travelling cable support

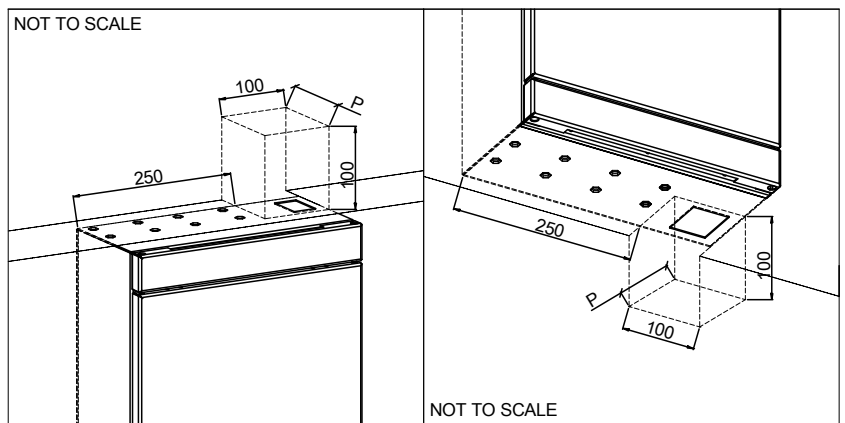

DRAWING	DATE	REV.	SHEET	[*] Unbounded dimensions in drawings are indicative and not binding.	
MP	2016	00	2/8		
MODEL LIFT:				REFERENCE:	
MP GO! FLEX XL				MPGO!FLEXLLATERAL375S_EN	
CAPACITY: [N° PERSONS]				CLIENT:	
NOMINAL LOAD: [kg]				WORK SITUATION:	
SPEED: [m/s]					
FREQUENCY: [Hz]					
TENSION: [V]					
380V [Three-phase]					
					MP LIFTS

02-SIDE VERTICAL SECTION

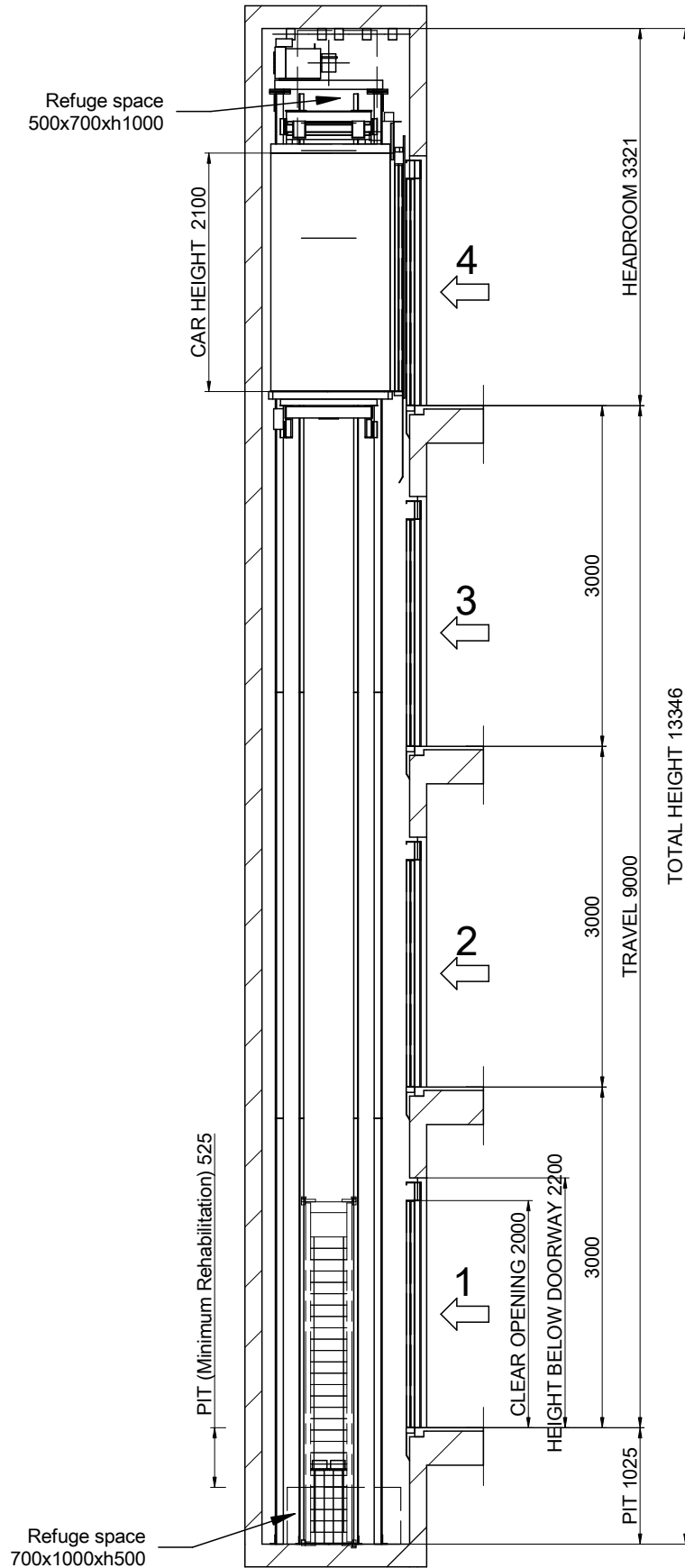

SCALE^[1]: 1:60

Flat and levelled floor, protected against water leaking.
 [EN81-20:2014 5.2.1.9]
 Foresee pit access device
 [EN81-20:2014 5.2.2.4]
 Stop device
 [EN81-20:2014 5.2.1.5.1. a]
 Inspection control station.
 [EN81-20:2014 5.2.1.5.1. b]
 Power supply
 [EN81-20:2014 5.2.1.5.1. c]
 Light switch commuted with the cabinet.
 [EN81-20:2014 5.2.1.5.1. d]

DRAWING		DATE	REV.	SHEET	[1] Unbounded dimensions in drawings are indicative and not binding.
MP	2016	00	3/8	REFERENCE: MPGOIFLEXLLATERAL375S_EN	
MODEL LIFT:		MP GO! FLEX XL			CLIENT: WORK SITUATION:
CAPACITY: [N° PERSONS]		5			
NOMINAL LOAD: [kg]		375			
SPEED: [m/s]		1			
FREQUENCY: [Hz]		50			
TENSION: [V]		380V [Three-phase]			MP LIFTS

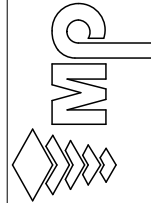

03B-FIXING DETAILS IN HEADROOM

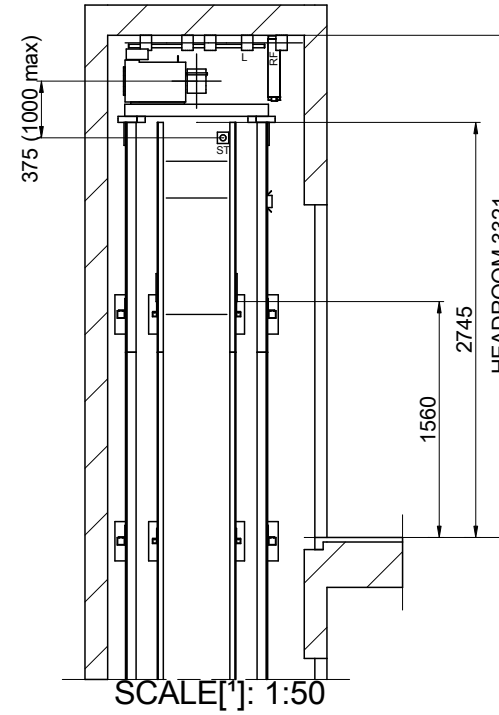
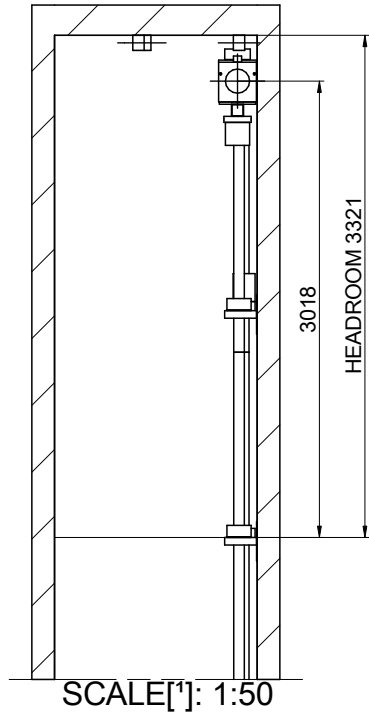

DRAWING	DATE	REV.	SHEET	[*] Unbounded dimensions in drawings are indicative and not binding.	
MP	2016	00	4/8		
MODEL LIFT:				REFERENCE: MPGO!FLEXLLATERAL375S_EN	
MP GO! FLEX XL				CLIENT:	
CAPACITY: [N° PERSONS]			5	WORK SITUATION:	
NOMINAL LOAD: [kg]			375		
SPEED: [m/s]			1		
FREQUENCY: [Hz]			50		
TENSION: [V]			380V [Three-phase]	MP LIFTS	

04-BEAM AND LIFTING HOOKS

POSITION OF REMOVABLE LIFTING HOOKS ABLE TO SUPPORT
1000 kg EACH ONE SUPPLIED BY CONSTRUCTOR
(RECOMMENDED POSITION LOADHOOKS)

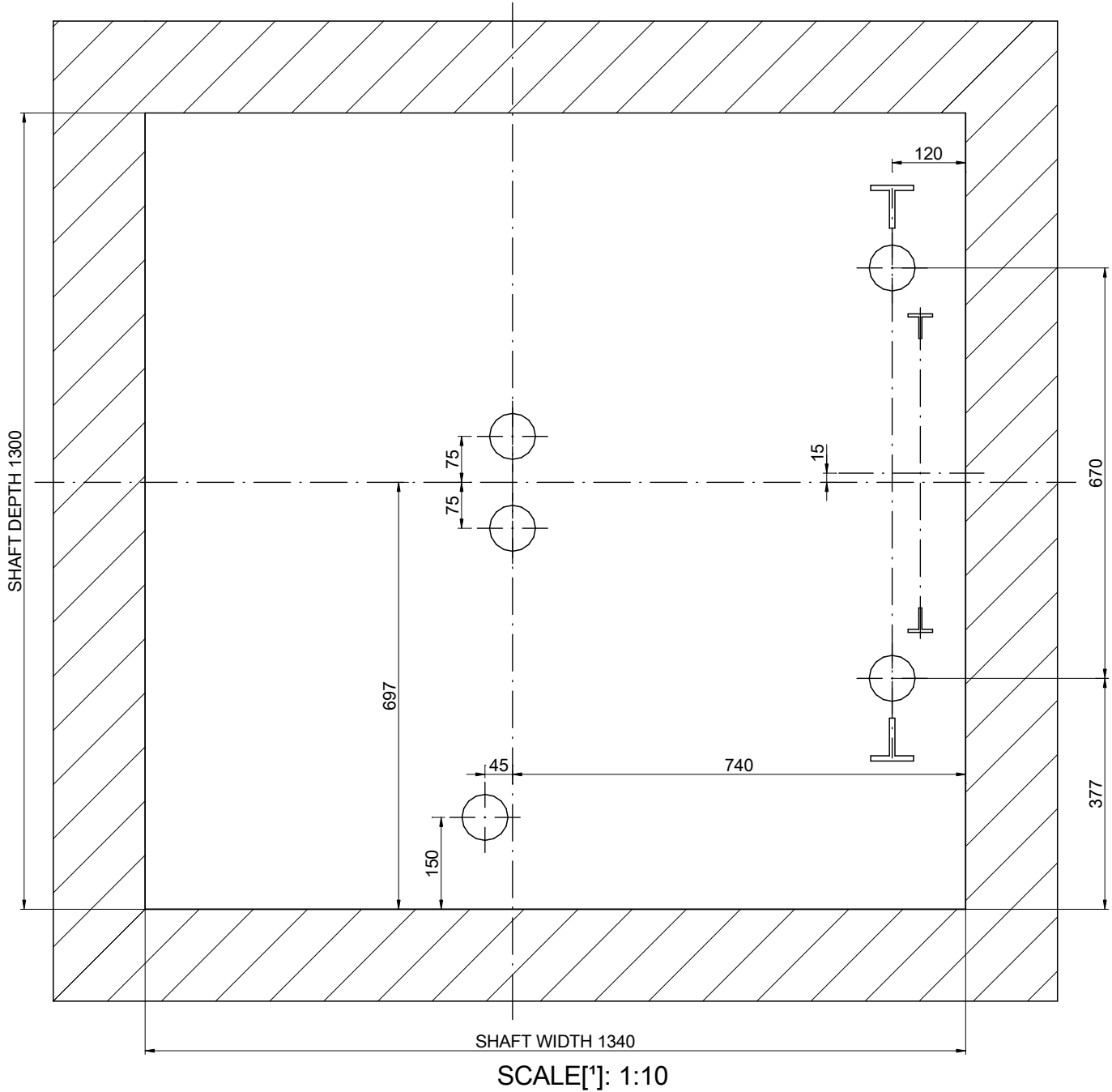

DRAWING	DATE	REV.	SHEET	[*] Unbounded dimensions in drawings are indicative and not binding.	
MP	2016	00	5/8	REFERENCE: MPGO!FLEXLLATERAL375S_EN	
MODEL LIFT:				CLIENT:	WORK SITUATION:
MP GO! FLEX XL					
CAPACITY: [N° PERSONS]			5	<h2>MP LIFTS</h2>	
NOMINAL LOAD: [kg]			375		
SPEED: [m/s]			1		
FREQUENCY: [Hz]			50		
TENSION: [V]			380V [Three-phase]		

05-PIT LAYOUT

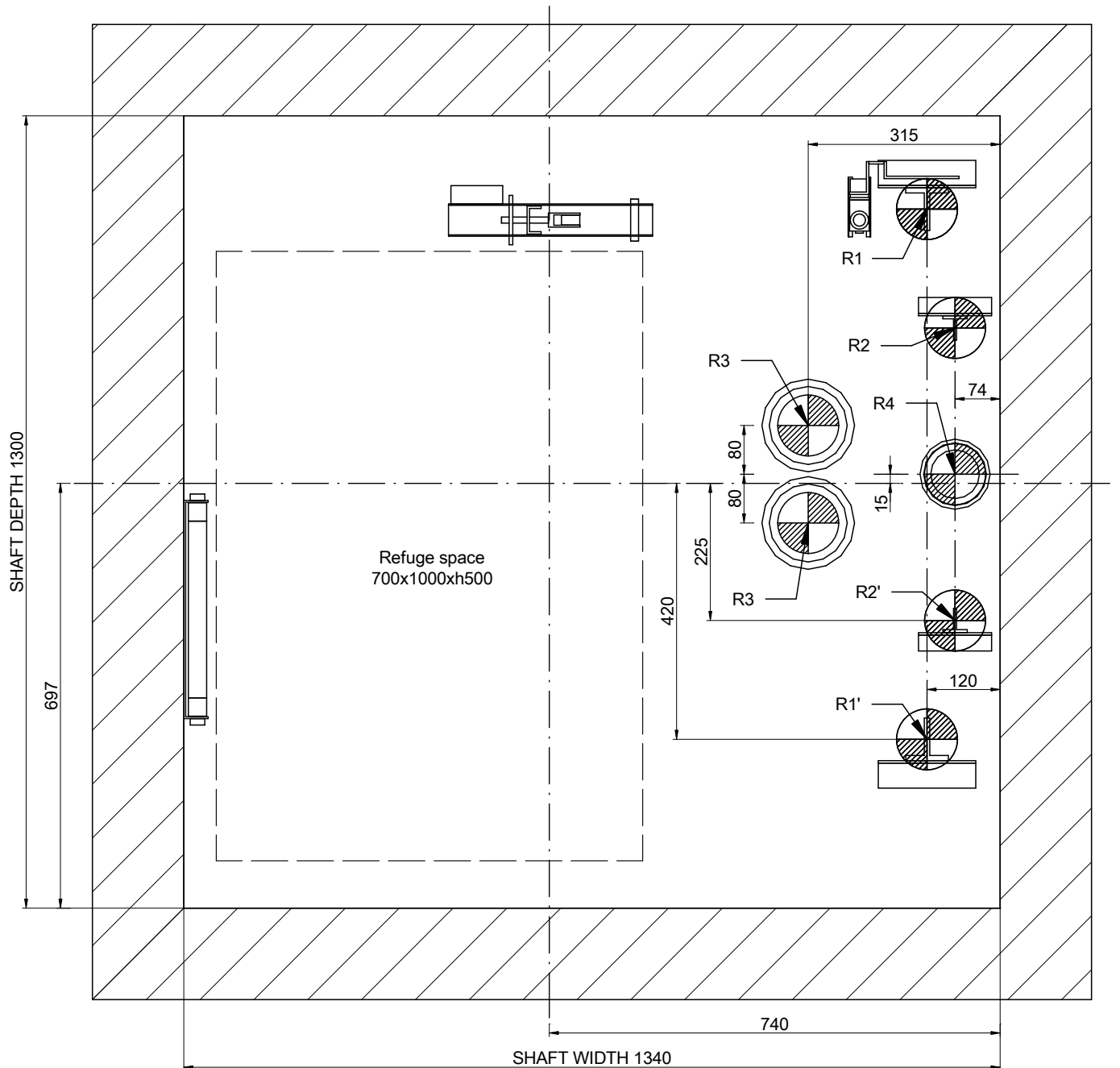

SCALE[*]: 1:10

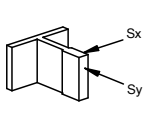

REACTIONS [N] [max.]			
R1	33000	R2	3000
R1'	33000	R2'	3000
R3	23500	R4	35000
Sx	3100	Sy	1000

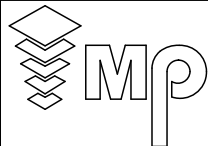

DRAWING	DATE	REV.	SHEET	[*] Unbounded dimensions in drawings are indicative and not binding. REFERENCE: MPGOIFLEXXLLATERAL375S_EN	
MP	2016	00	6/8		
MODEL LIFT:				CLIENT: WORK SITUATION:	
MP GO! FLEX XL					
CAPACITY: [N° PERSONS]			5		
NOMINAL LOAD: [kg]			375		
SPEED: [m/s]			1		
FREQUENCY: [Hz]			50		
TENSION: [V]			380V [Three-phase]	MP LIFTS	

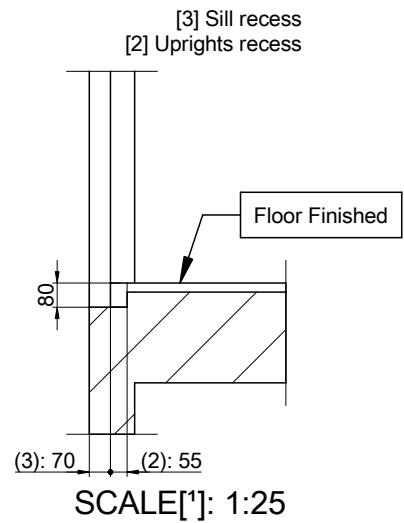
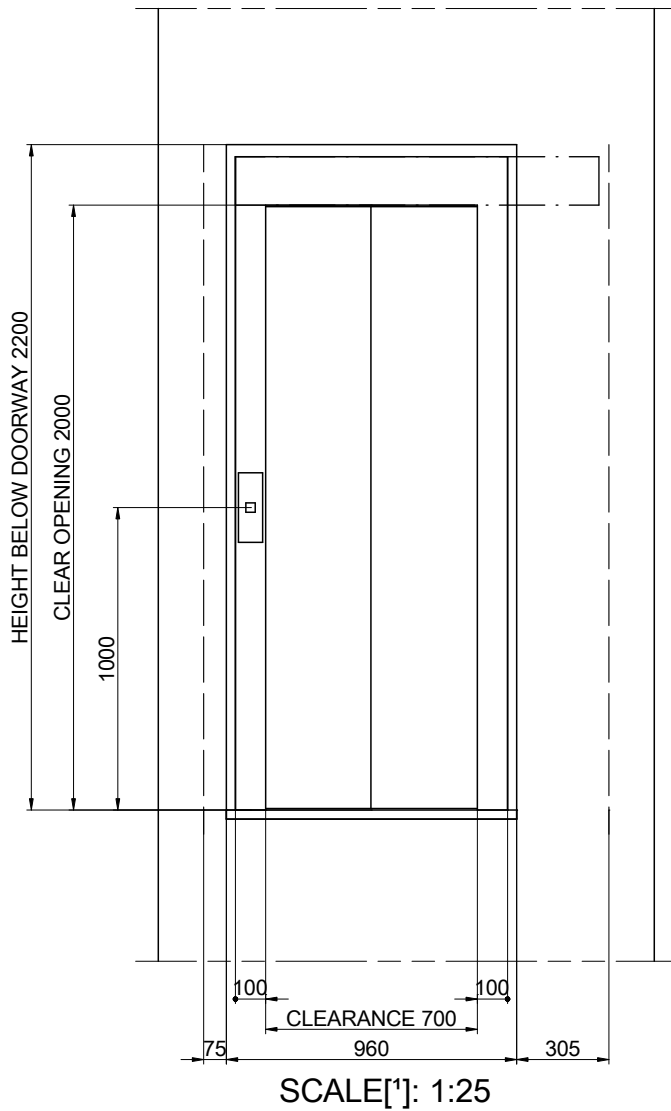
06-DOOR HOLE DETAIL



DRAWING	DATE	REV.	SHEET	[*] Unbounded dimensions in drawings are indicative and not binding.	
MP	2016	00	7/8	REFERENCE: MPGO!FLEXLLATERAL375S_EN	
MODEL LIFT:				CLIENT:	
MP GO! FLEX XL				WORK SITUATION:	
CAPACITY: [N° PERSONS]			5		
NOMINAL LOAD: [kg]			375		
SPEED: [m/s]			1		
FREQUENCY: [Hz]			50		
TENSION: [V]			380V [Three-phase]		
				MP LIFTS	

07-HEADROOM

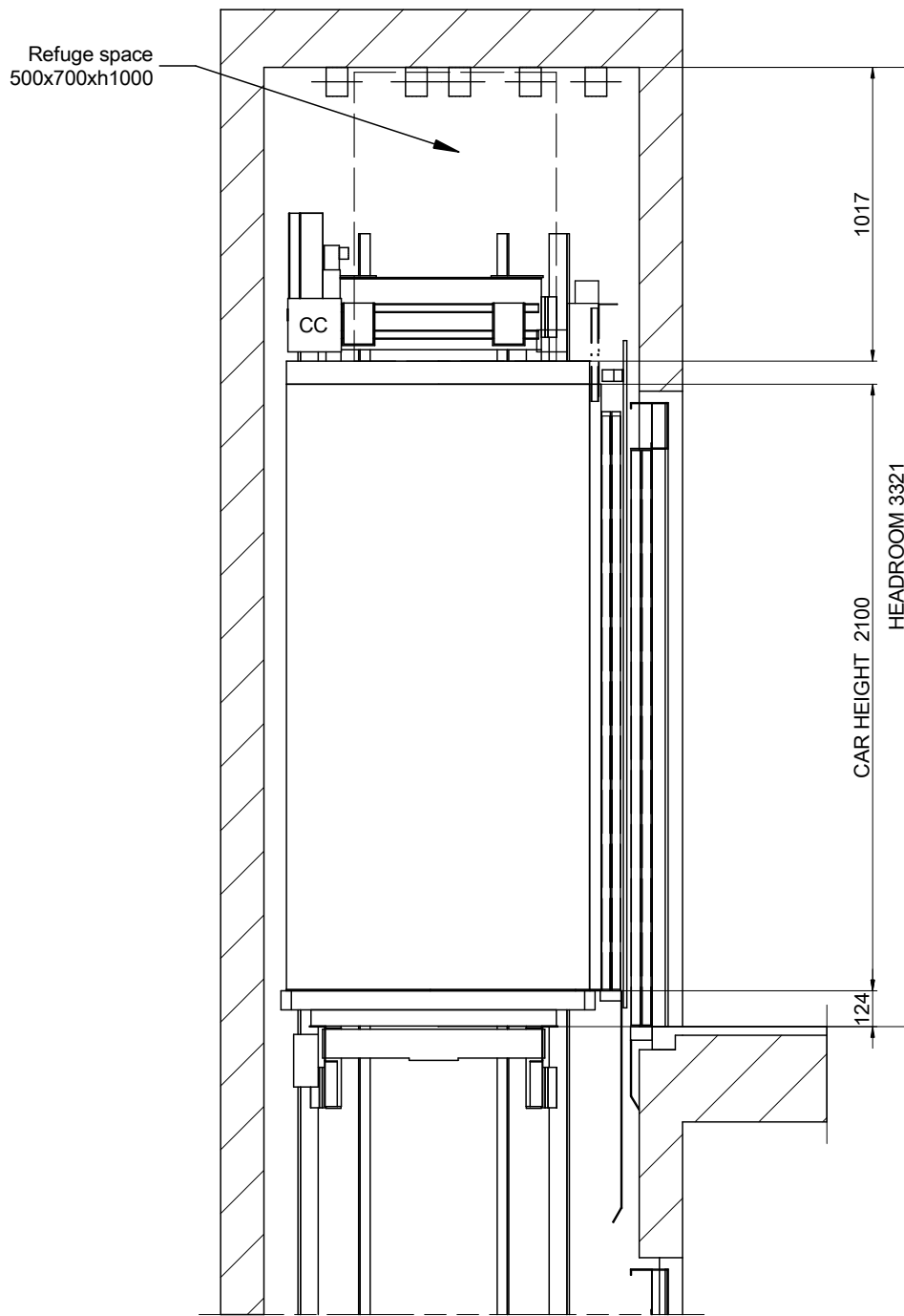

SCALE[*]: 1:25

DRAWING	DATE	REV.	SHEET	[*] Unbounded dimensions in drawings are indicative and not binding. REFERENCE: MPGO!FLEXLLATERAL375S_EN	
MP	2016	00	8/8		
MODEL LIFT:				CLIENT:	WORK SITUATION:
MP GO! FLEX XL					
CAPACITY: [N° PERSONS]			5	<h2>MP LIFTS</h2>	
NOMINAL LOAD: [kg]			375		
SPEED: [m/s]			1		
FREQUENCY: [Hz]			50		
TENSION: [V]			380V [Three-phase]		