

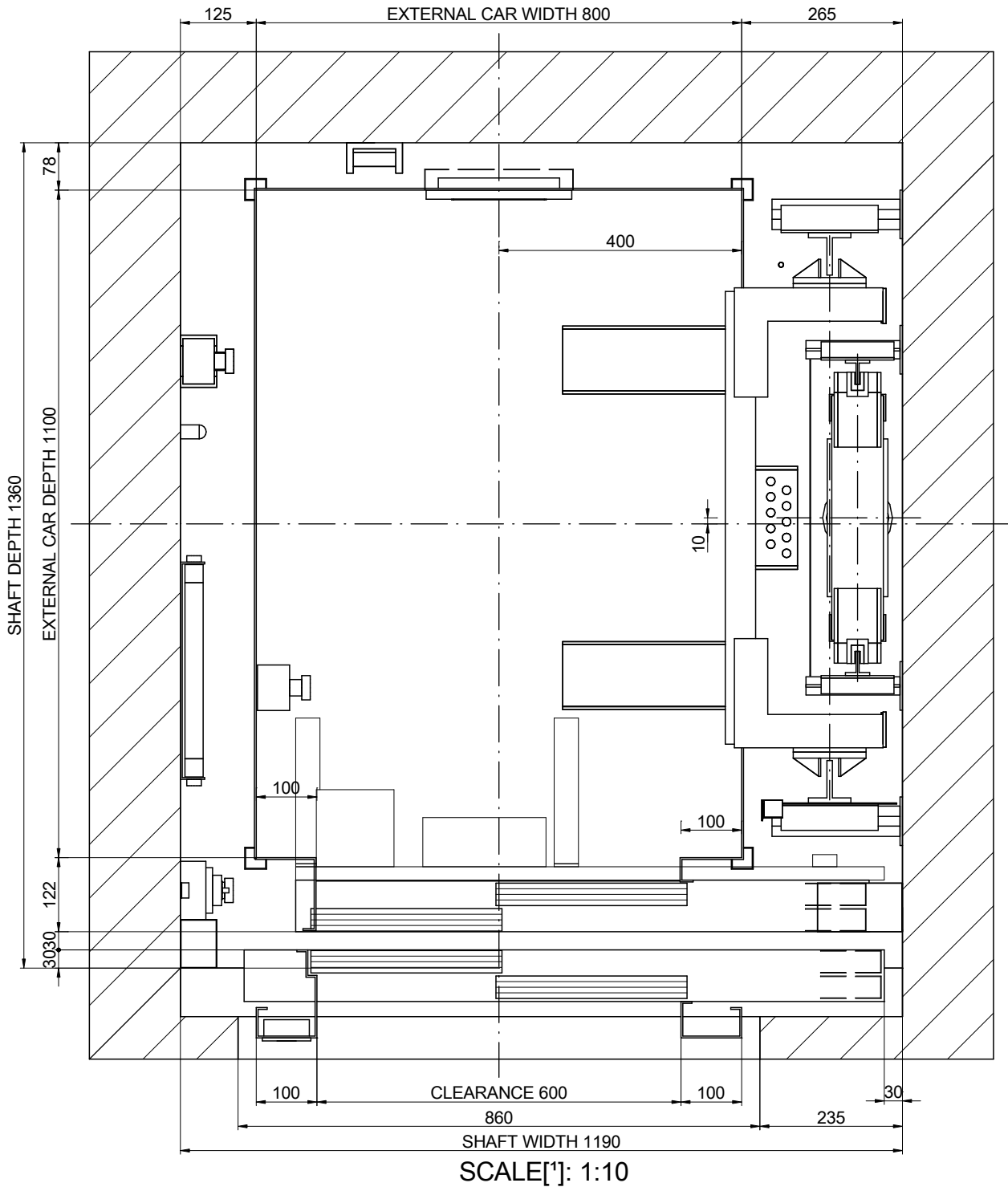

01-PLAN VIEW



DRAWING	DATE	REV.	SHEET	[*] Unbounded dimensions in drawings are indicative and not binding.	
MP	2016	00	1/8	REFERENCE: MPGO!FLEXLLATERAL320S_EN	
MODEL LIFT:				CLIENT: WORK SITUATION:	<p style="text-align: center; font-size: 2em; font-weight: bold;">MP LIFTS</p>
MP GO! FLEX XL					
CAPACITY: [N° PERSONS]			4		
NOMINAL LOAD: [kg]			320		
SPEED: [m/s]			1		
FREQUENCY: [Hz]			50		
TENSION: [V]		380V [Three-phase]			

01B-PLAN VIEW

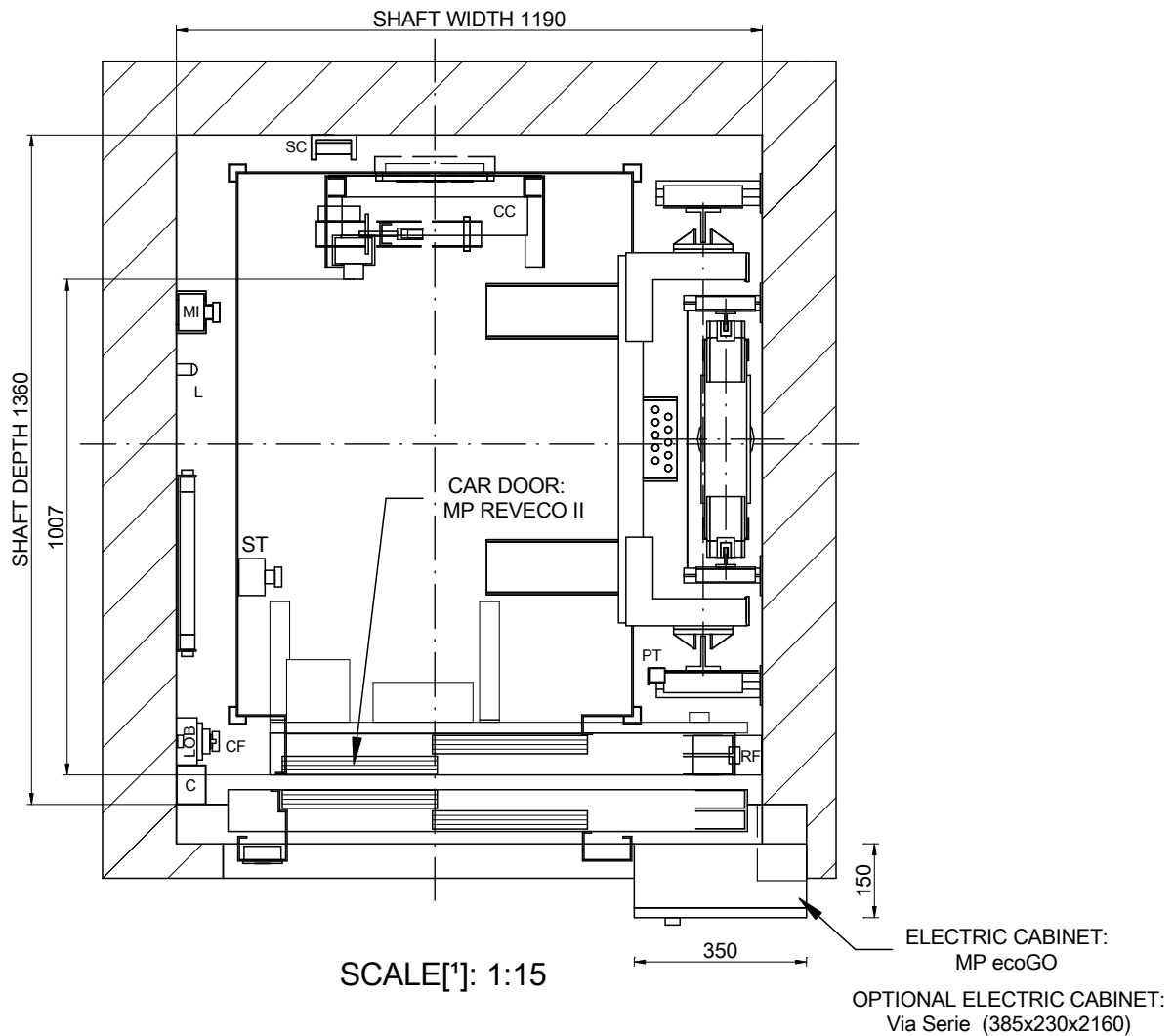

NOMENCLATURE

C: Wiring channel
 CC: Car ceiling connection box
 CF: Pit box
 CL: Shaft light switch
 DOC: Operator control box
 L: Lamp
 LOB: Pushbutton control board
 MI: Inspection control station
 PT: Fixed cam
 RF: Brake resistor
 ST: Stopping device
 SC: Travelling cable support

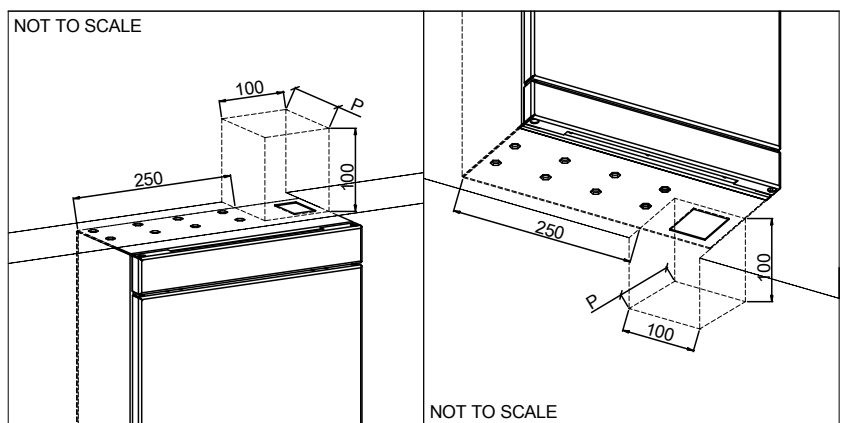

DRAWING	DATE	REV.	SHEET	[*] Unbounded dimensions in drawings are indicative and not binding. REFERENCE: MPGO!FLEXLLATERAL320S_EN	
MP	2016	00	2/8		
MODEL LIFT:				CLIENT:	MP LIFTS
MP GO! FLEX XL					
CAPACITY: [N° PERSONS]			4	WORK SITUATION:	
NOMINAL LOAD: [kg]			320		
SPEED: [m/s]			1		
FREQUENCY: [Hz]			50		
TENSION: [V]			380V [Three-phase]		

02-SIDE VERTICAL SECTION

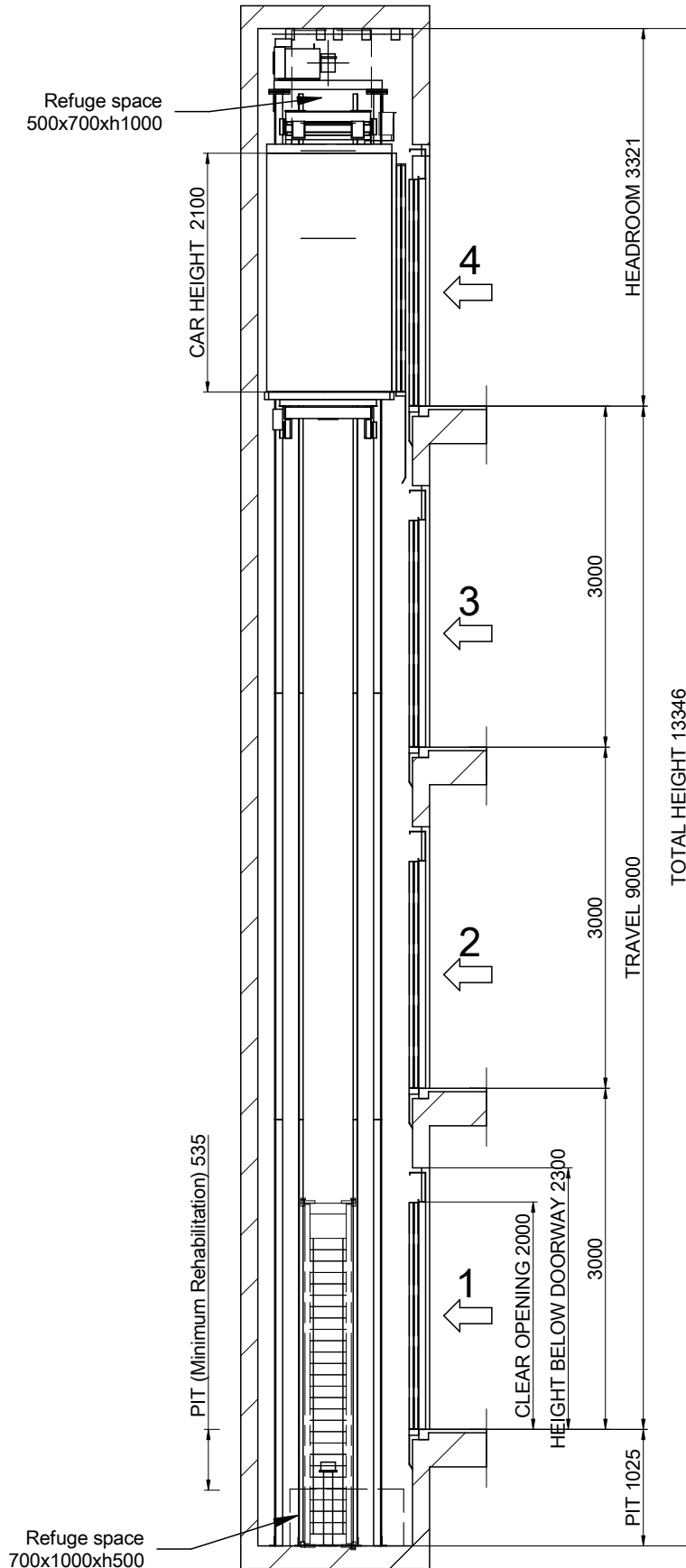

SCALE[*]: 1:60

DRAWING		DATE	REV.	SHEET	[!] Unbounded dimensions in drawings are indicative and not binding.
MP	2016	00	3/8	REFERENCE: MPGOIFLEXLLATERAL320S_EN	
MODEL LIFT:		MP GO! FLEX XL			CLIENT: WORK SITUATION:
CAPACITY: [N° PERSONS]		4			
NOMINAL LOAD: [kg]		320			
SPEED: [m/s]		1			
FREQUENCY: [Hz]		50			
TENSION: [V]		380V [Three-phase]			
MP LIFTS					

Flat and levelled floor, protected against water leaking.
 [EN81-20:2014 5.2.1.9]
 Foresee pit access device
 [EN81-20:2014 5.2.2.4]
 Stop device
 [EN81-20:2014 5.2.1.5.1. a]
 Inspection control station.
 [EN81-20:2014 5.2.1.5.1. b]
 Power supply
 [EN81-20:2014 5.2.1.5.1. c]
 Light switch commuted with the cabinet.
 [EN81-20:2014 5.2.1.5.1. d]



03B-FIXING DETAILS IN HEADROOM

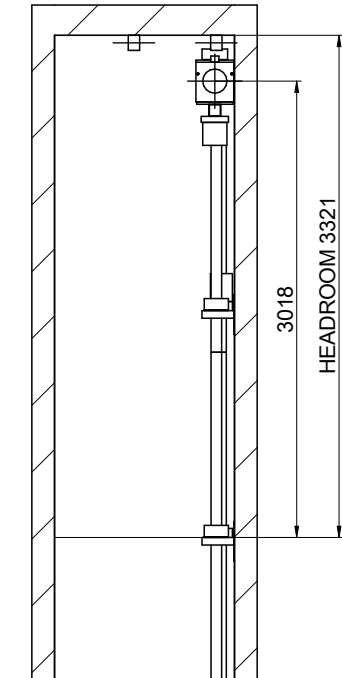

SCALE[*]: 1:50

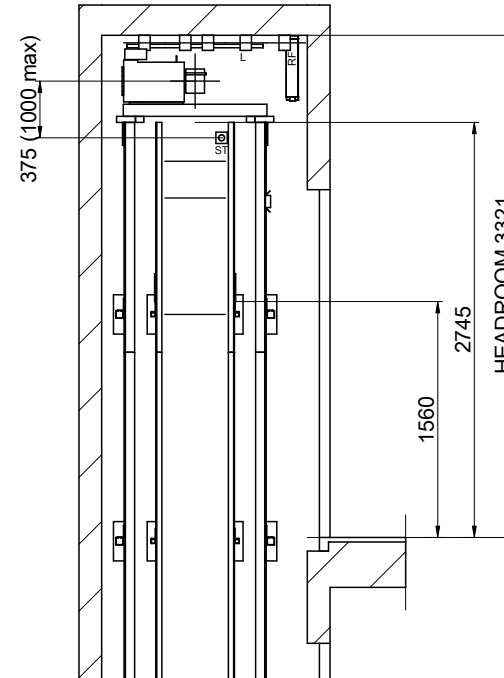

SCALE[*]: 1:50

DRAWING	DATE	REV.	SHEET	[*] Unbounded dimensions in drawings are indicative and not binding.	
MP	2016	00	4/8		
MODEL LIFT:				REFERENCE:	
MP GO! FLEX XL				MPGO!FLEXLLATERAL320S_EN	
CAPACITY: [N° PERSONS]				CLIENT:	
4				WORK SITUATION:	
NOMINAL LOAD: [kg]				<p style="text-align: center; font-size: 24pt; font-weight: bold;">MP LIFTS</p>	
320					
SPEED: [m/s]					
1					
FREQUENCY: [Hz]					
50					
TENSION: [V]					
380V [Three-phase]					

04-BEAM AND LIFTING HOOKS

POSITION OF REMOVABLE LIFTING HOOKS ABLE TO SUPPORT
1000 kg EACH ONE SUPPLIED BY CONSTRUCTOR
(RECOMMENDED POSITION LOADHOOKS)

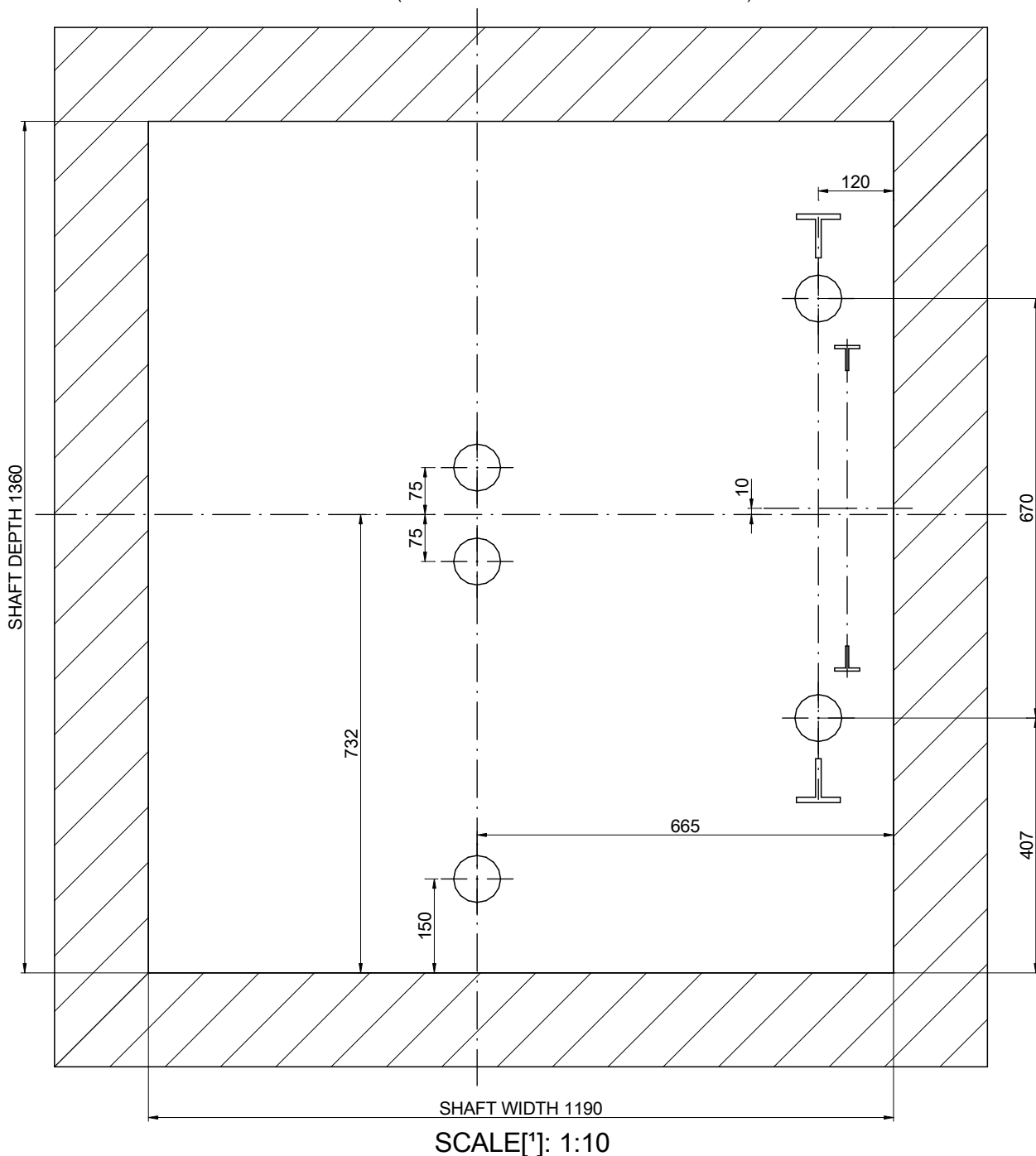

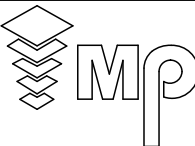
DRAWING	DATE	REV.	SHEET	[*] Unbounded dimensions in drawings are indicative and not binding.	
MP	2016	00	5/8	REFERENCE: MPGO!FLEXLLATERAL320S_EN	
MODEL LIFT:				CLIENT: WORK SITUATION:	<p>MP LIFTS</p>
MP GO! FLEX XL					
CAPACITY: [N° PERSONS]			4		
NOMINAL LOAD: [kg]			320		
SPEED: [m/s]			1		
FREQUENCY: [Hz]			50		
TENSION: [V]		380V [Three-phase]			

05-PIT LAYOUT

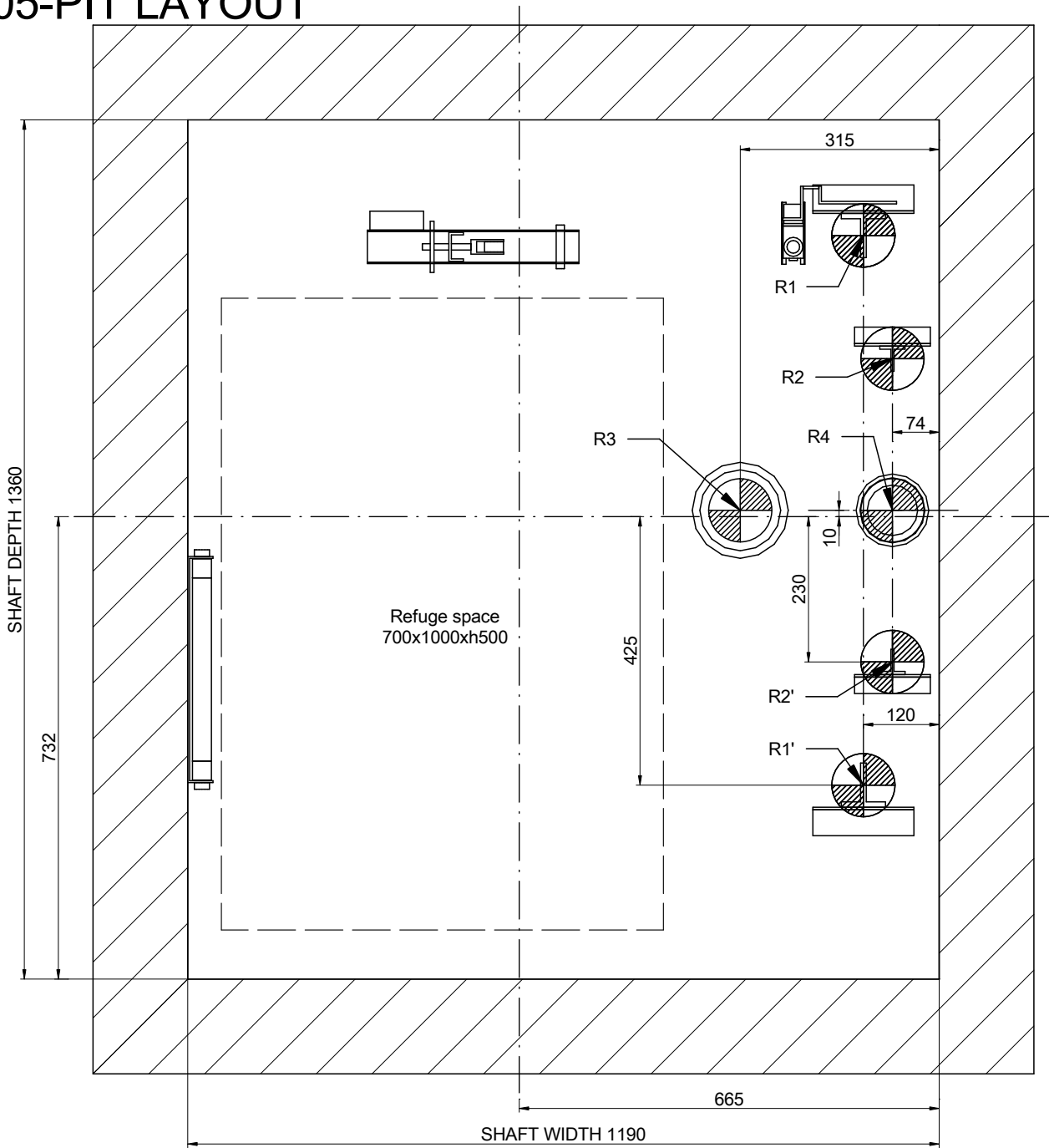

SCALE[*]: 1:10

REACTIONS [N] [max.]					
R1	30000	R2	3000		
R1'	30000	R2'	3000		
R3	40000	R4	33000		
Sx	2900	Sy	900		

DRAWING	DATE	REV.	SHEET
MP	2016	00	6/8
MODEL LIFT:			
MP GO! FLEX XL			
CAPACITY: [N° PERSONS]			4
NOMINAL LOAD: [kg]			320
SPEED: [m/s]			1
FREQUENCY: [Hz]			50
TENSION: [V]		380V [Three-phase]	

[*] Unbounded dimensions in drawings are indicative and not binding.

REFERENCE:
MPGO!FLEXLLATERAL320S_EN



CLIENT:
WORK SITUATION:

MP LIFTS

06-DOOR HOLE DETAIL

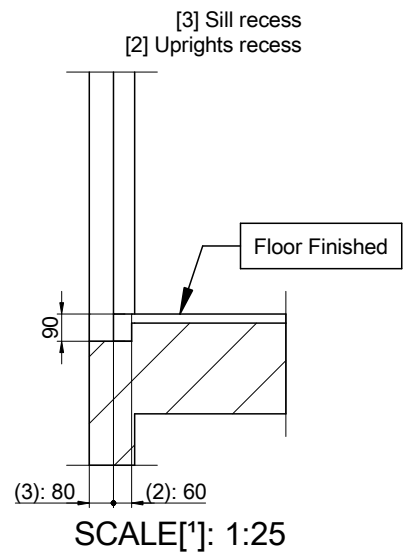
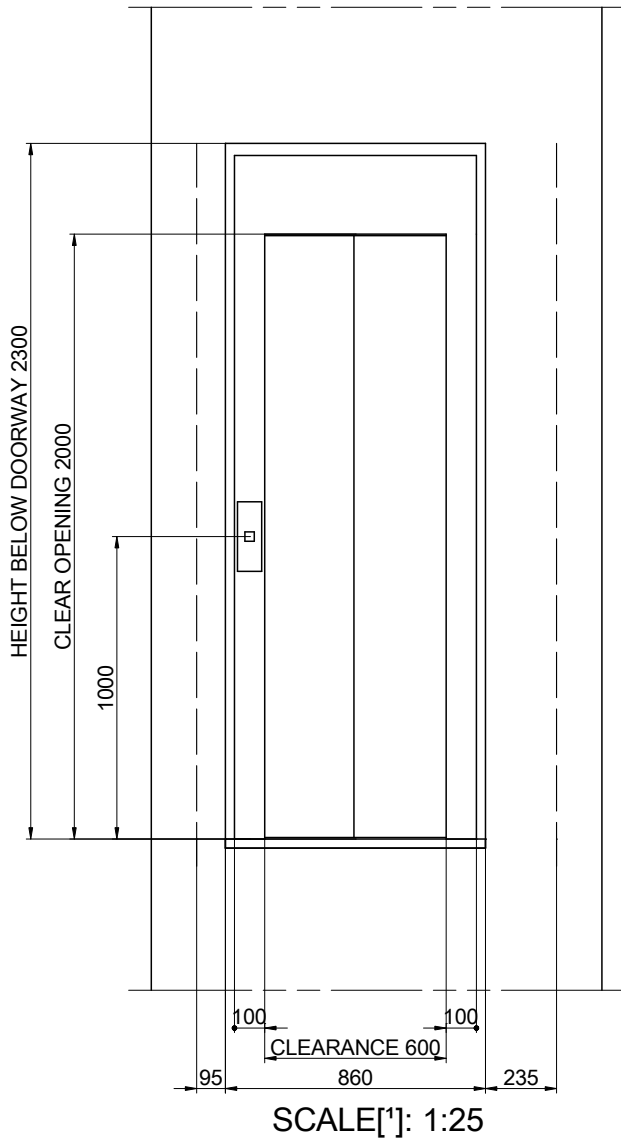

DRAWING	DATE	REV.	SHEET	[*] Unbounded dimensions in drawings are indicative and not binding.	
MP	2016	00	7/8	REFERENCE: MPGO!FLEXLLATERAL320S_EN	
MODEL LIFT:				CLIENT: WORK SITUATION:	
MP GO! FLEX XL					
CAPACITY: [N° PERSONS]			4		
NOMINAL LOAD: [kg]			320		
SPEED: [m/s]			1		
FREQUENCY: [Hz]			50		
TENSION: [V]			380V [Three-phase]	MP LIFTS	

07-HEADROOM

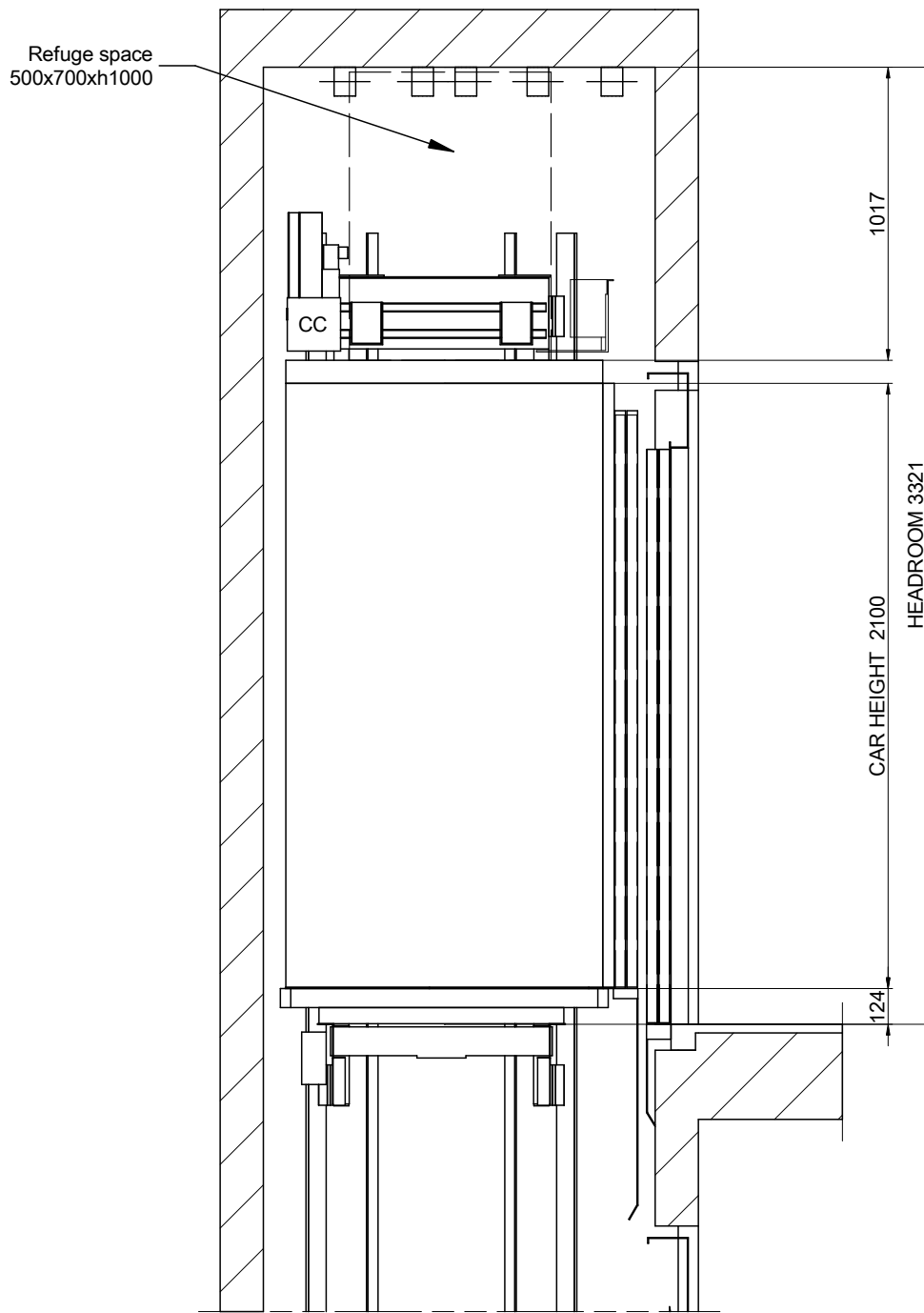

SCALE[*]: 1:25

DRAWING	DATE	REV.	SHEET	[*] Unbounded dimensions in drawings are indicative and not binding.	
MP	2016	00	8/8		
MODEL LIFT:				REFERENCE:	<p>CLIENT:</p> <p>WORK SITUATION:</p>
MP GO! FLEX XL				MPGO!FLEXLLATERAL320S_EN	
CAPACITY: [N° PERSONS]			4		
NOMINAL LOAD: [kg]			320		
SPEED: [m/s]			1		
FREQUENCY: [Hz]			50		
TENSION: [V]			380V [Three-phase]		
				MP LIFTS	