

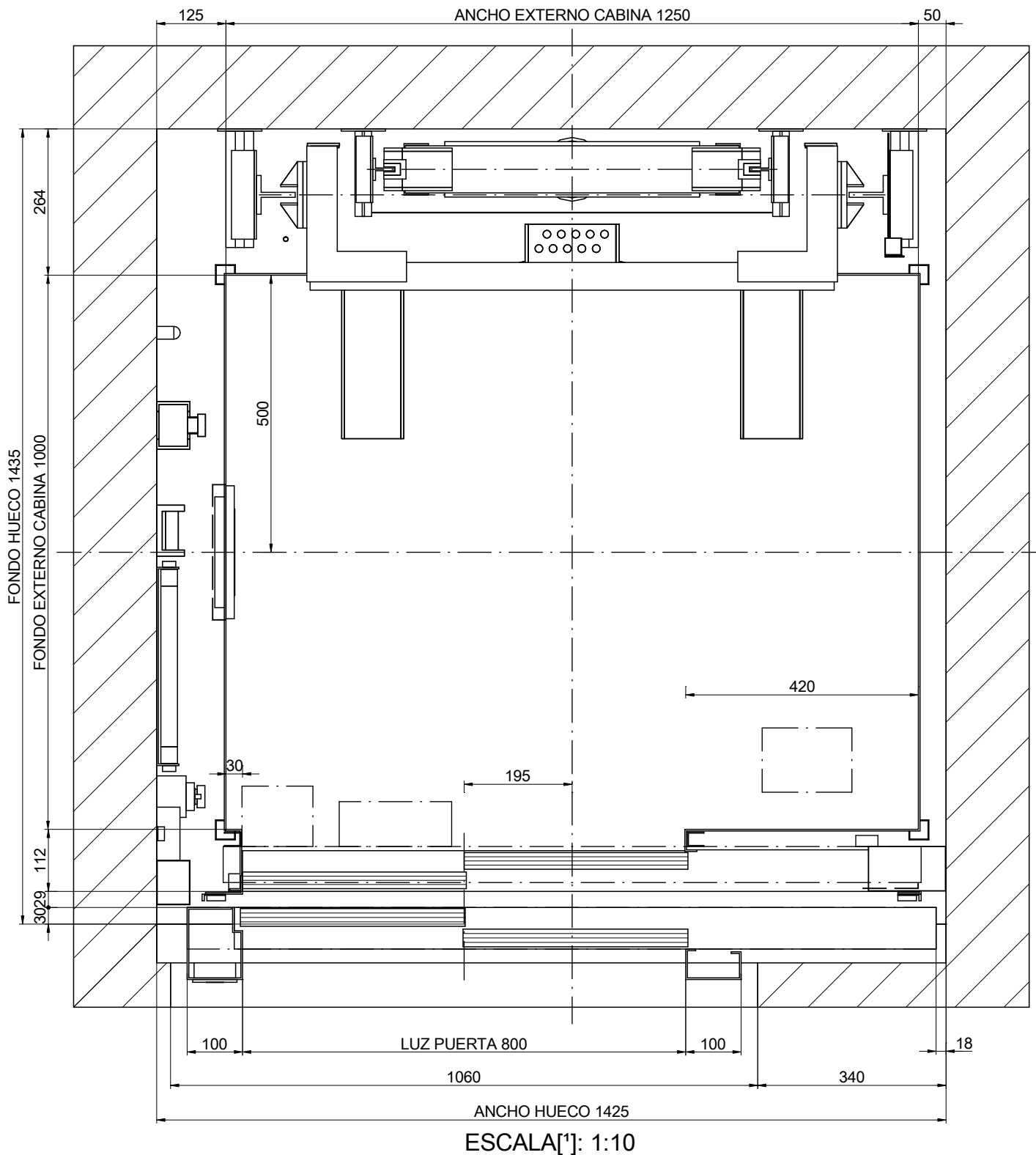

01-PLANTA



DIBUJADO	FECHA	REV.	HOJA	[*] Las dimensiones no acotadas en el plano son indicativas y no vinculantes.	
MP	2016	00	1/8		
MODELO ASCENSOR:				REFERENCIA:	
MP GO! FLEX XL				MPGO!FLEXXLFONDO480S_ES	
CAPACIDAD: [Nº PERSONAS]				6	CLIENTE:
CARGA UTIL: [kg]				480	SITUACION OBRA:
VELOCIDAD: [m/s]				1	
FRECUENCIA: [Hz]				50	
TENSION: [V]				380V [Trifásica]	
MP ASCENSORES					

01B-PLANTA

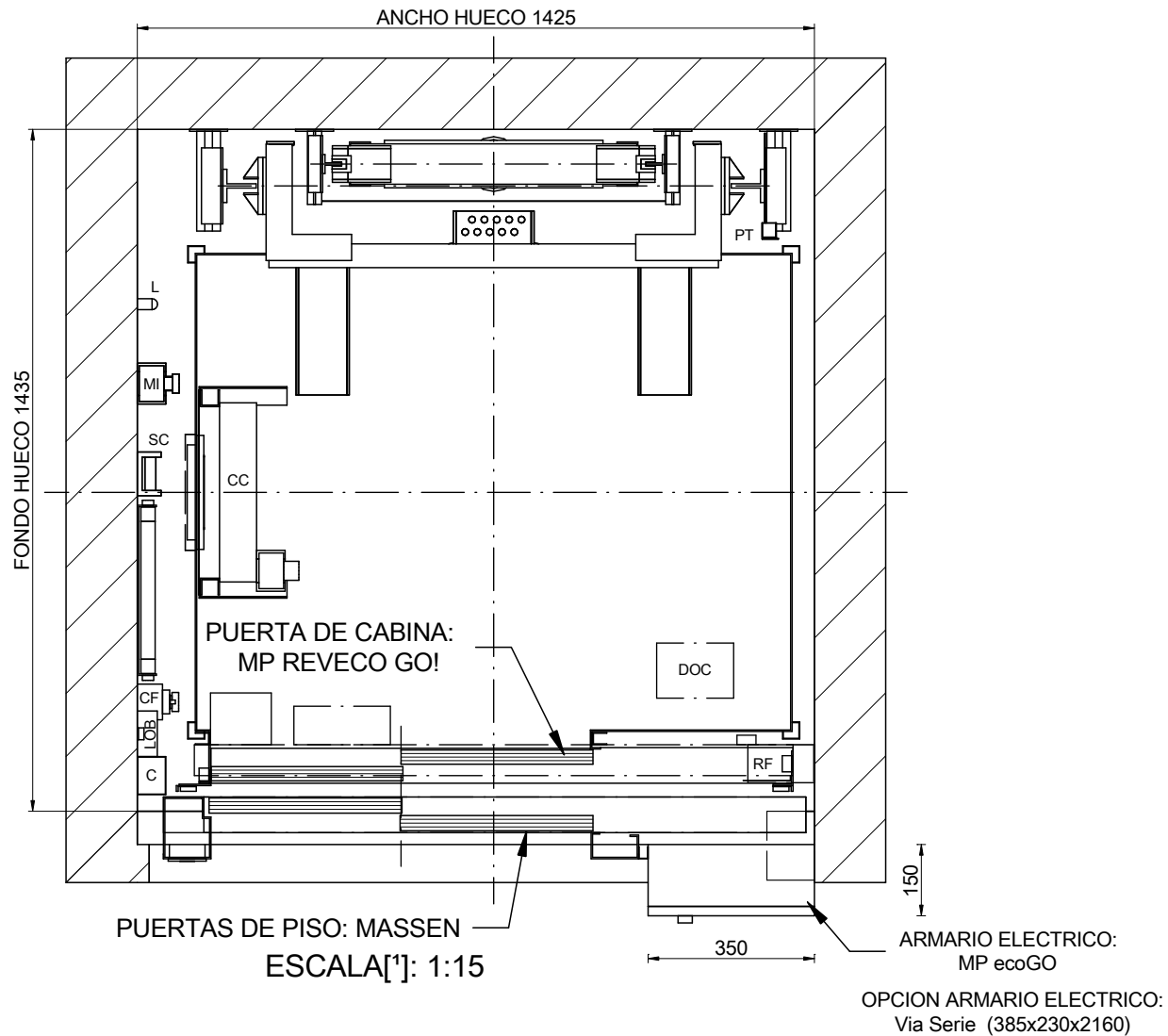

NOMENCLATURA

- C: Canaleta
- CC: Caja conexiones techo cabina
- CF: Caja foso
- CL: Conmutador Luz Hueco
- DOC: Caja Control Operador
- L: Luminaria
- LOB: Placa Control Botoneras
- MI: Mando Inspección
- PT: Patín
- RF: Resistencia Frenado
- ST: Dispositivo parada
- SC: Soporte cuerda maniobra

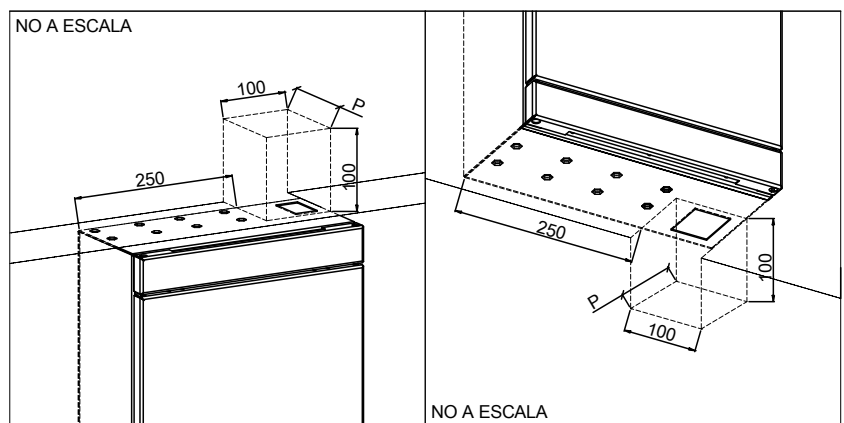

DIBUJADO	FECHA	REV.	HOJA	[*] Las dimensiones no acotadas en el plano son indicativas y no vinculantes.	
MP	2016	00	2/8		
MODELO ASCENSOR:				REFERENCIA:	
MP GO! FLEX XL				MPGO!FLEXXLFONDO480S_ES	
CAPACIDAD: [Nº PERSONAS]				6	
CARGA UTIL: [kg]				480	
VELOCIDAD: [m/s]				1	
FRECUENCIA: [Hz]				50	
TENSION: [V]				380V [Trifásica]	
				CLIENTE:	
				SITUACION OBRA:	
				MP ASCENSORES	

02-ALZADO LATERAL

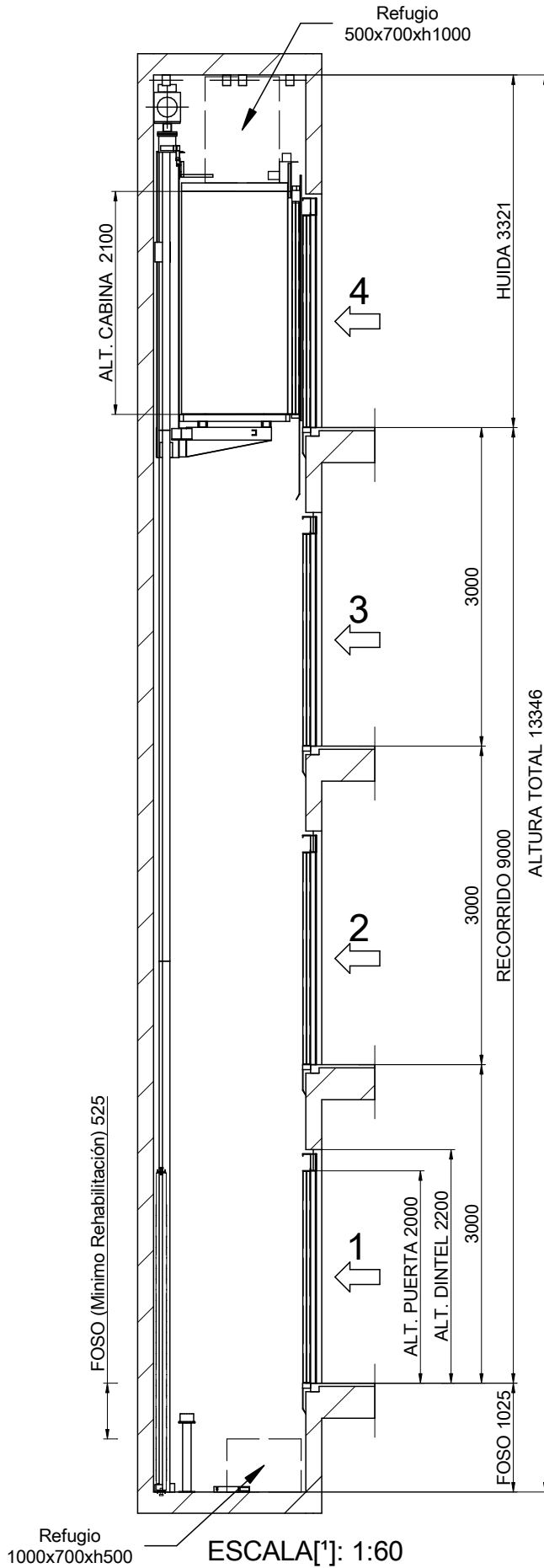

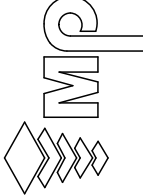
		[*] Las dimensiones no acotadas en el plano son indicativas y no vinculantes.	
		REFERENCIA: MPGOIFLEXXLFONDO480S_ES	CLIENTE: SITUACION OBRA:
DIBUJADO MP	FECHA 2016	REV. 00	HOJA 3/8
MODELO ASCENSOR: MP GO! FLEX XL			
CAPACIDAD: [N° PERSONAS]		6	
CARGA UTIL: [kg]		480	
VELOCIDAD: [m/s]		1	
FRECUENCIA: [Hz]		50	
TENSION: [V]		380V [Trifásica]	
MP ASCENSORES			

Foso liso y a nivel protegido de infiltraciones de agua.
 [EN81-20:2014 5.2.1.9]
 Prever dispositivo de acceso.
 [EN81-20:2014 5.2.2.4]
 Dispositivo de parada.
 [EN81-20:2014 5.2.1.5.1. a)
 Estación de control de inspección.
 [EN81-20:2014 5.2.1.5.1 b)
 Toma de corriente.
 [EN81-20:2014 5.2.1.5.1. c)
 Interruptor de alumbrado, conmutado con el armario.
 [EN81-20:2014 5.2.1.5.1. d)

03B-DETALLES DE FIJACION EN LA HUIDA

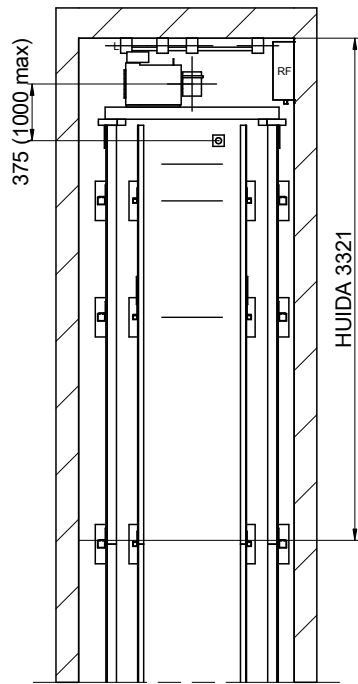

ESCALA[*]: 1:50

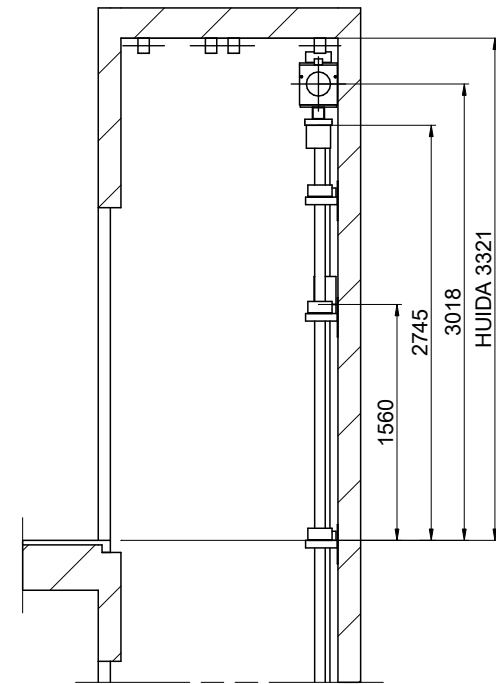

ESCALA[*]: 1:50

DIBUJADO	FECHA	REV.	HOJA	[*] Las dimensiones no acotadas en el plano son indicativas y no vinculantes.	
MP	2016	00	4/8		
MODELO ASCENSOR:				REFERENCIA: MPGO!FLEXXLFONDO480S_ES	
MP GO! FLEX XL				CLIENTE:	
CAPACIDAD: [Nº PERSONAS]		6		SITUACION OBRA:	
CARGA UTIL: [kg]		480			
VELOCIDAD: [m/s]		1			
FRECUENCIA: [Hz]		50			
TENSION: [V]		380V [Trifásica]		MP ASCENSORES	

04-VIGA Y GANCHOS DE MONTAJE

POSICION DE LOS GANCHOS DESMONTABLES CAPACES DE SOPORTAR
1000 kg CADA UNO A SUMINISTRAR POR EL CONSTRUCTOR
(POSICION RECOMENDADA GANCHOS DE MONTAJE)

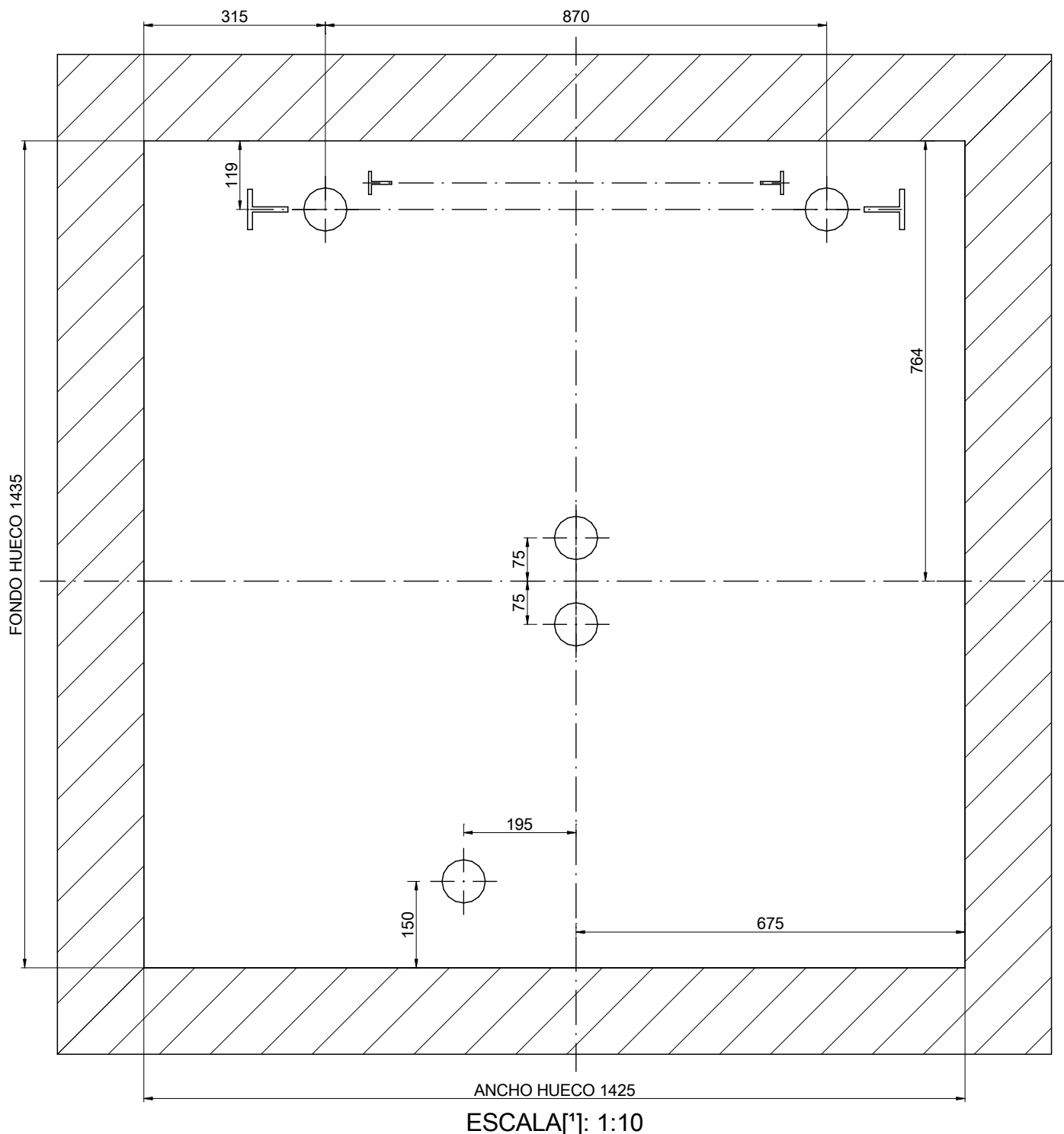

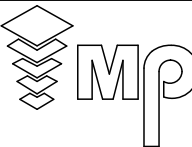
DIBUJADO	FECHA	REV.	HOJA	[*] Las dimensiones no acotadas en el plano son indicativas y no vinculantes.	
MP	2016	00	5/8		
MODELO ASCENSOR:				REFERENCIA:	
MP GO! FLEX XL				MPGO!FLEXXLFONDO480S_ES	
CAPACIDAD: [Nº PERSONAS]				6	CLIENTE:
CARGA UTIL: [kg]				480	SITUACION OBRA:
VELOCIDAD: [m/s]				1	
FRECUENCIA: [Hz]				50	
TENSION: [V]				380V [Trifásica]	MP ASCENSORES

05-PLANTA DE FOSO

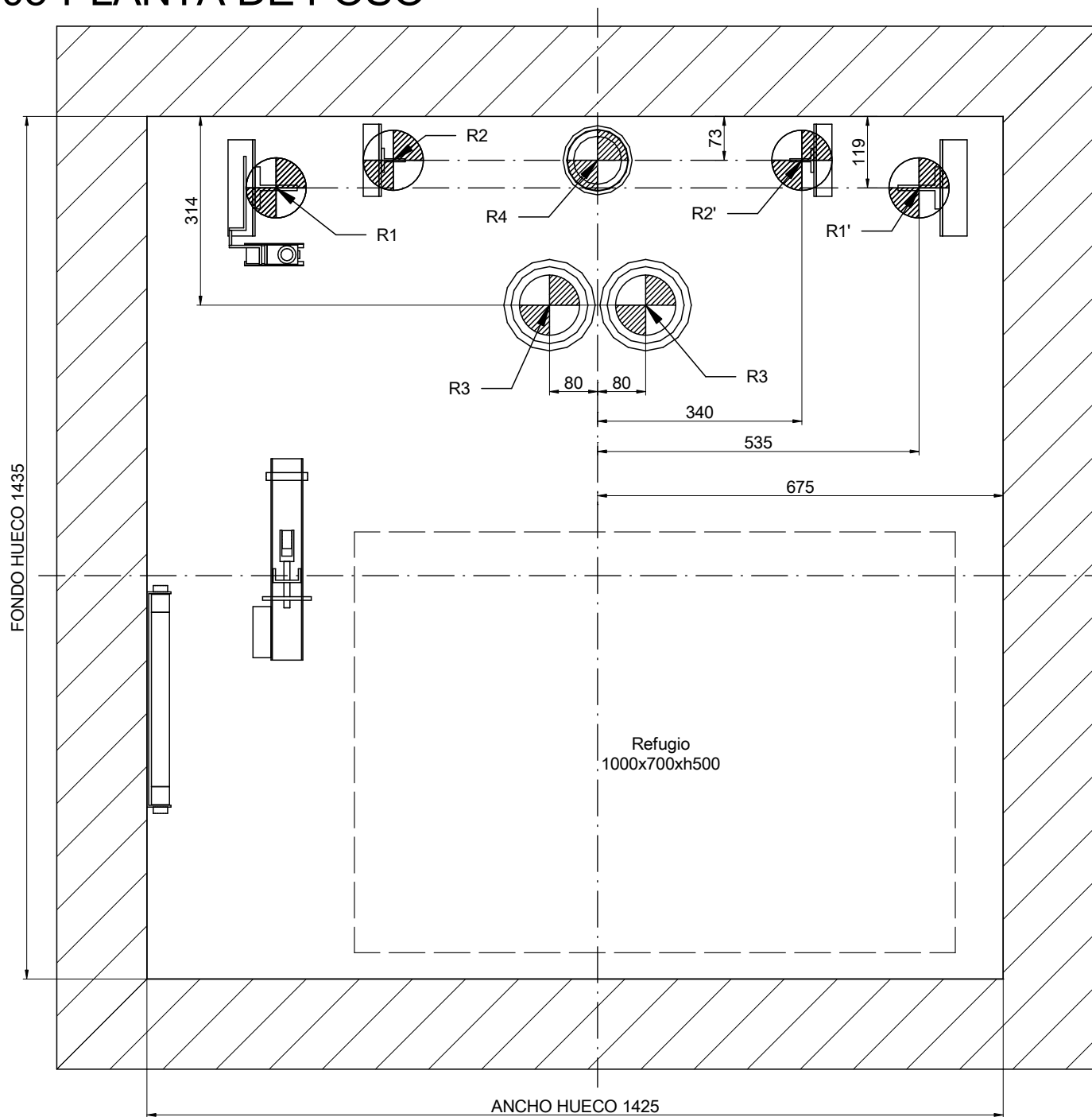

ESCALA[*]: 1:10

REACCIONES [N] [max.]			
R1	35000	R2	3000
R1'	35000	R2'	3000
R3	25000	R4	40000
Sx	3500	Sy	1100

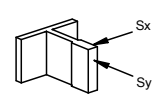

DIBUJADO	FECHA	REV.	HOJA
MP	2016	00	6/8
MODELO ASCENSOR:			
MP GO! FLEX XL			
CAPACIDAD: [Nº PERSONAS]		6	
CARGA UTIL: [kg]		480	
VELOCIDAD: [m/s]		1	
FRECUENCIA: [Hz]		50	
TENSION: [V]		380V [Trifásica]	

[*] Las dimensiones no acotadas en el plano son indicativas y no vinculantes.

REFERENCIA:
MPGO!FLEXXLFONDO480S_ES

CLIENTE:
SITUACION OBRA:

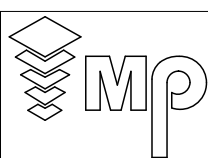

MP ASCENSORES

06-DETALLE DE HUECO DE PUERTA

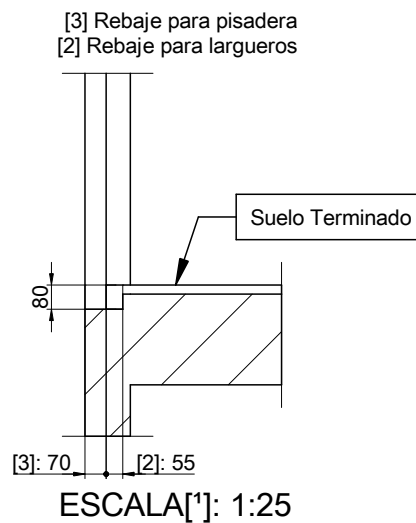
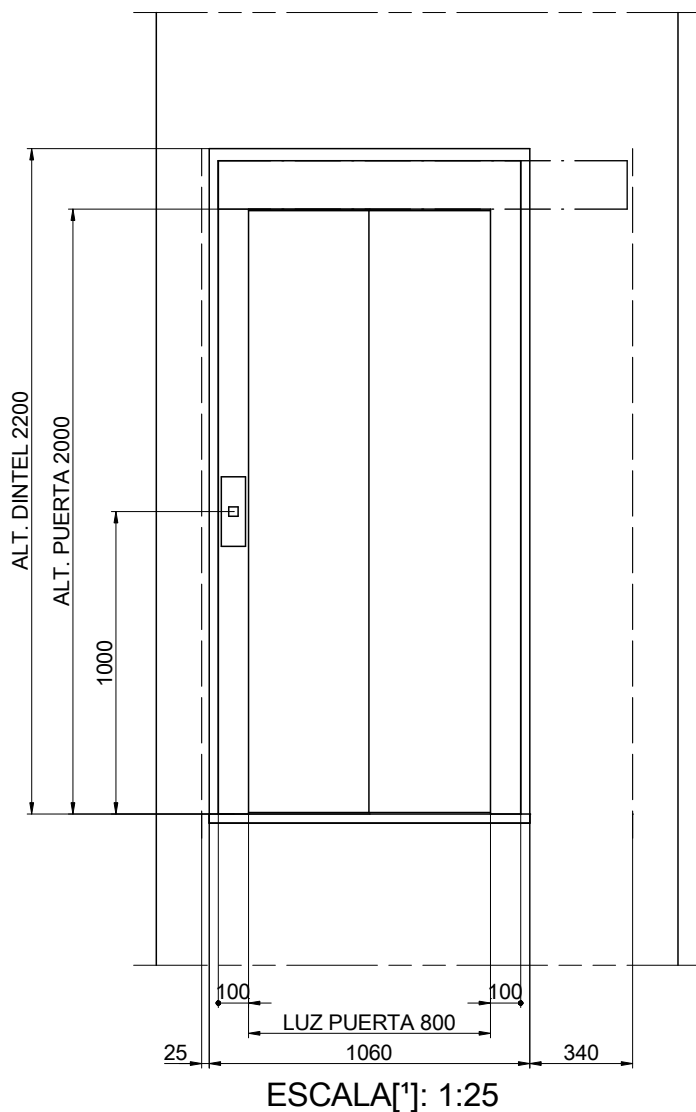

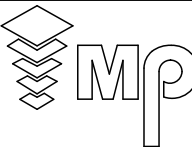
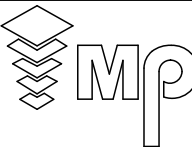
DIBUJADO	FECHA	REV.	HOJA	[*] Las dimensiones no acotadas en el plano son indicativas y no vinculantes.	
MP	2016	00	7/8		
MODELO ASCENSOR:				REFERENCIA:	
MP GO! FLEX XL				MPGO!FLEXXLFONDO480S_ES	
CAPACIDAD: [Nº PERSONAS]				6	CLIENTE: SITUACION OBRA:
CARGA UTIL: [kg]				480	
VELOCIDAD: [m/s]				1	
FRECUENCIA: [Hz]				50	
TENSION: [V]				380V [Trifásica]	
MP ASCENSORES					

07-HUIDA

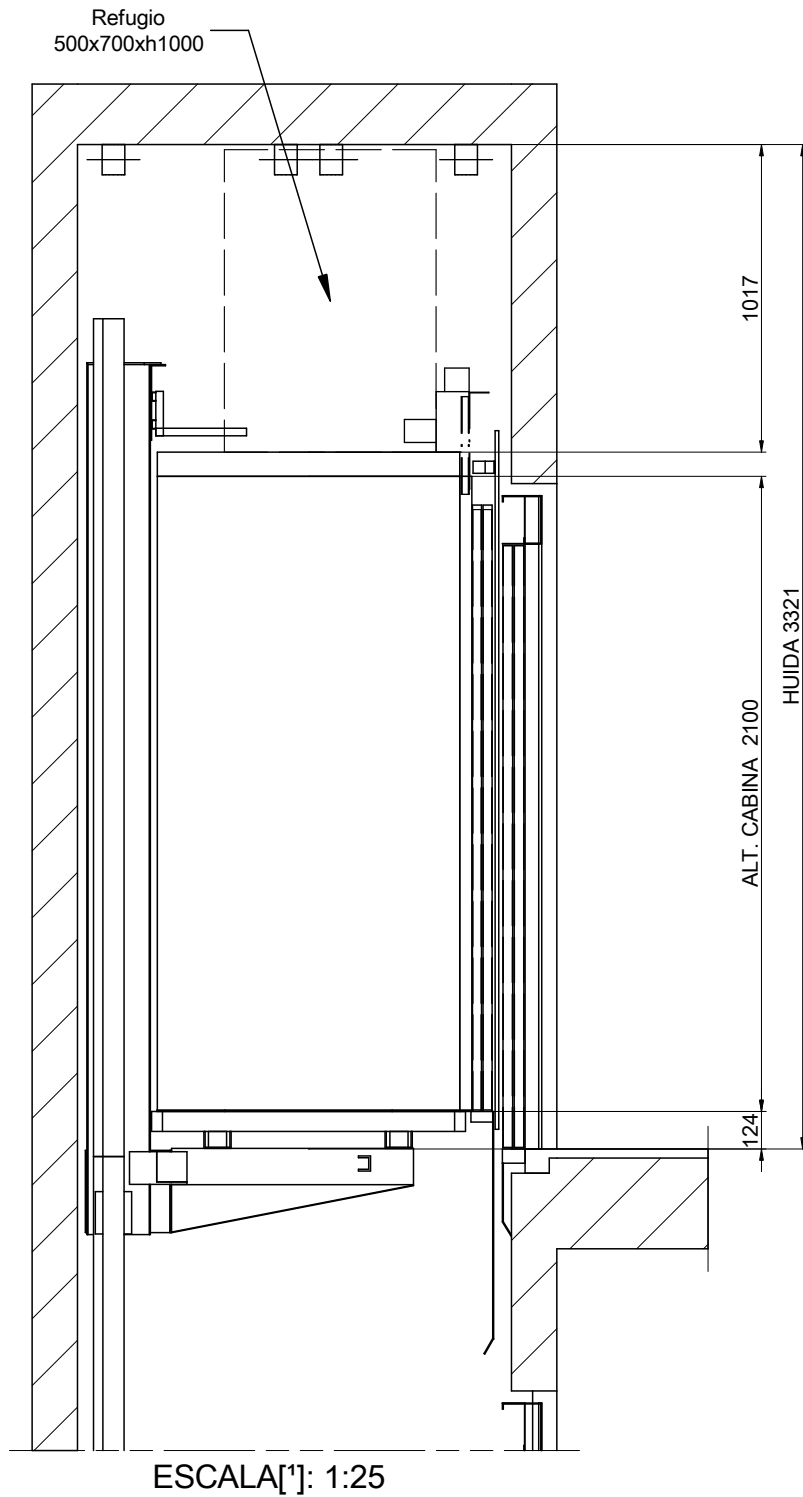

DIBUJADO	FECHA	REV.	HOJA	[*] Las dimensiones no acotadas en el plano son indicativas y no vinculantes.	
MP	2016	00	8/8		
MODELO ASCENSOR:				REFERENCIA:	
MP GO! FLEX XL				MPGO!FLEXXLFONDO480S_ES	
CAPACIDAD: [Nº PERSONAS]				6	CLIENTE: SITUACION OBRA:
CARGA UTIL: [kg]				480	
VELOCIDAD: [m/s]				1	
FRECUENCIA: [Hz]				50	
TENSION: [V]				380V [Trifásica]	
MP ASCENSORES					