

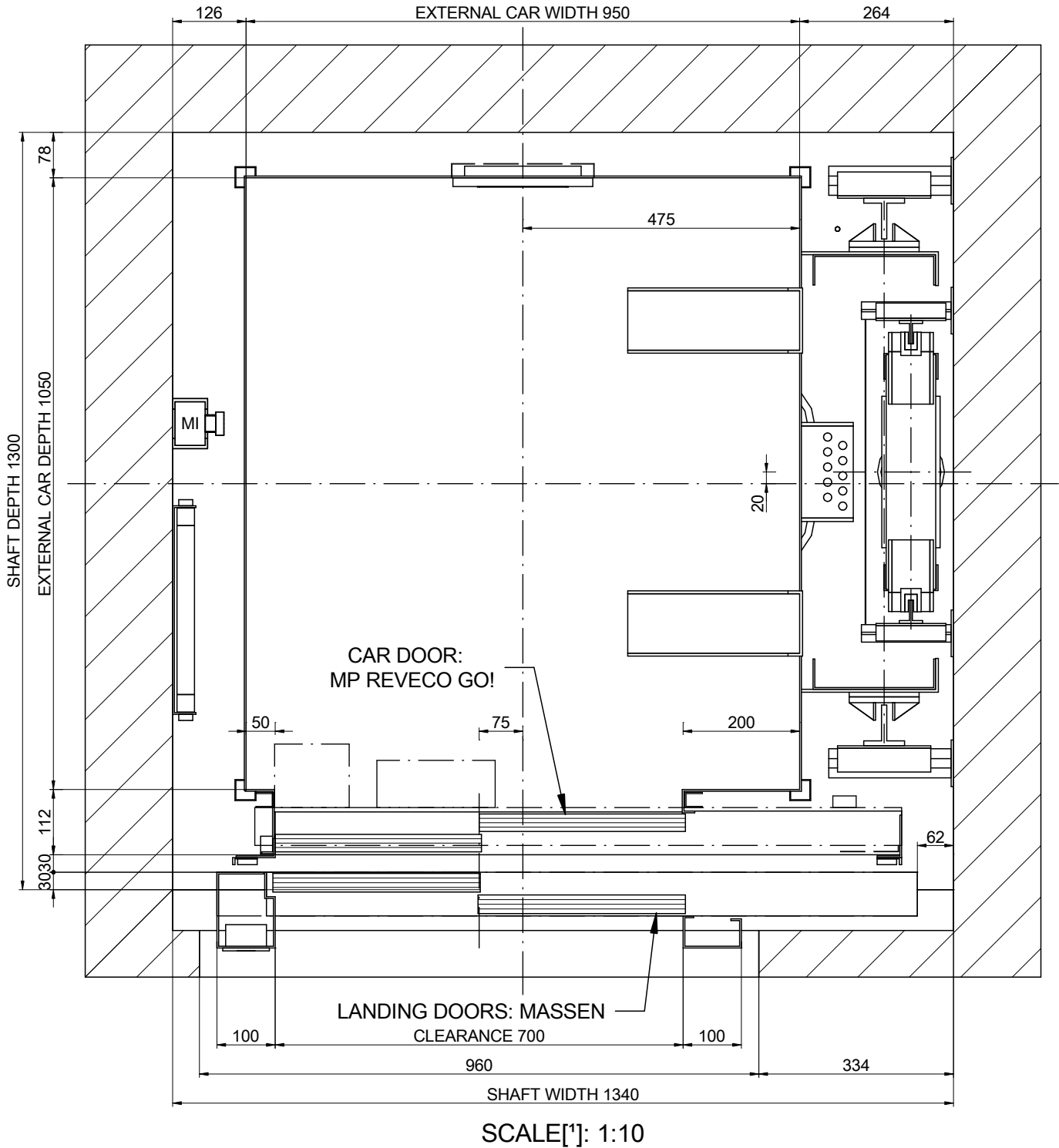

01-PLAN VIEW



NOMENCLATURE

CC: Car ceiling connection box
MI: Inspection control station

DRAWING	DATE	REV.	SHEET	[*] Unbounded dimensions in drawings are indicative and not binding. REFERENCE: MPGO!FLEXLLATERAL375C_EN	
MP	2017	00	1/7		
MODEL LIFT:				CLIENT:	WORK SITUATION:
MP GO! FLEX XL					
CAPACITY: [N° PERSONS]			5	MP LIFTS	
NOMINAL LOAD: [kg]			375		
SPEED: [m/s]			1		
FREQUENCY: [Hz]			50		
TENSION: [V]			380V [Three-phase]		

02-SIDE VERTICAL SECTION

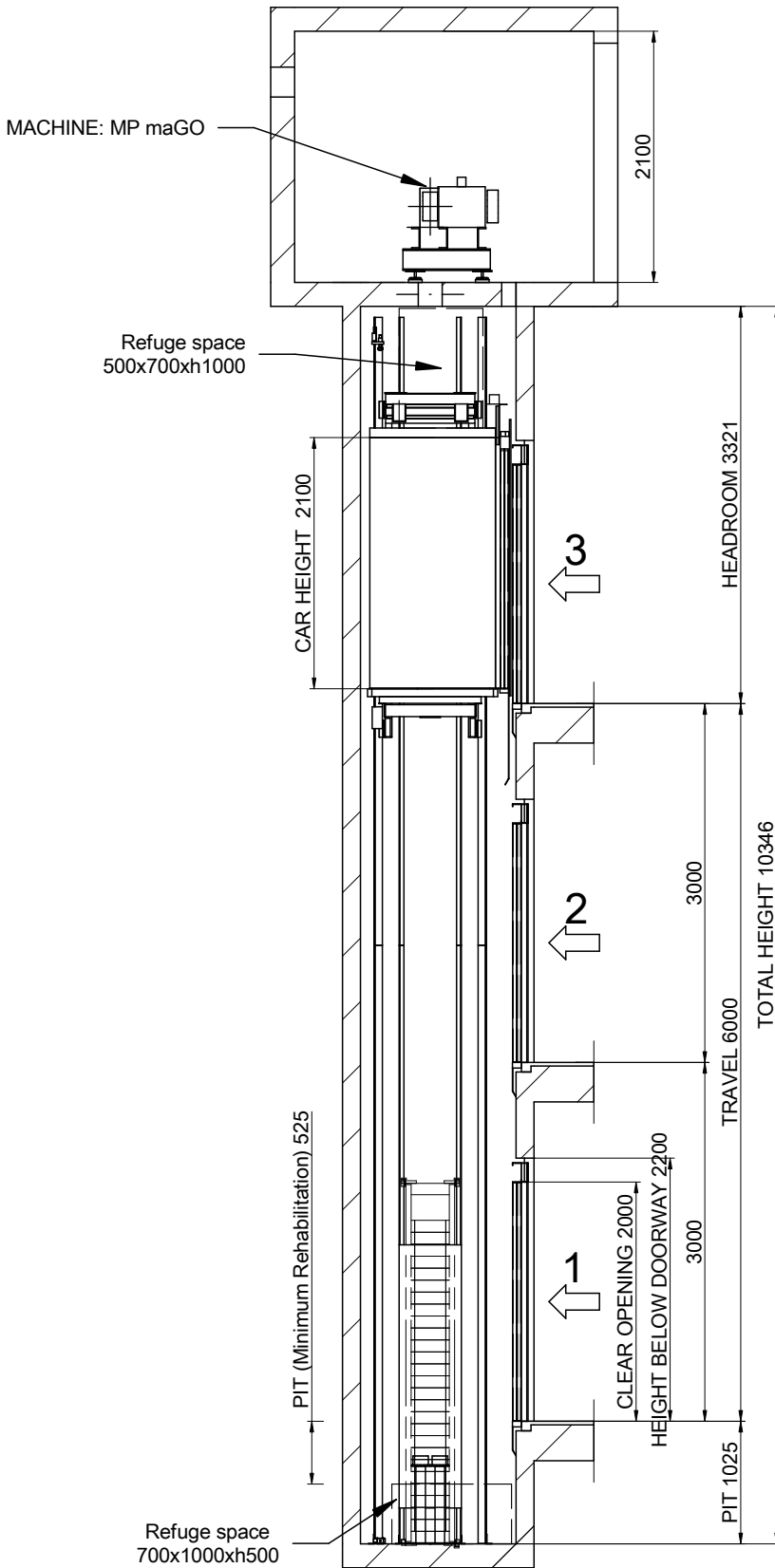

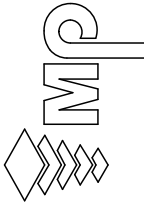

SCALE[*]: 1:60

		[*] Unbounded dimensions in drawings are indicative and not binding.	
		DRAWING	SHEET
MP	2017	00	2/7
MODEL LIFT:		MP GO! FLEX XL	
CAPACITY: [N° PERSONS]		5	
NOMINAL LOAD: [kg]		375	
SPEED: [m/s]		1	
FREQUENCY: [Hz]		50	
TENSION: [V]		380V [Three-phase]	
REFERENCE:		MPGO!FLEXLLATERAL375C_EN	
CLIENT:		WORK SITUATION:	
		MP LIFTS	

Flat and levelled floor, protected against water leaking.
 [EN81-20:2014 5.2.1.9]
 Foresee pit access device
 [EN81-20:2014 5.2.2.4]
 Stop device
 [EN81-20:2014 5.2.1.5.1. a)
 Inspection control station.
 [EN81-20:2014 5.2.1.5.1. b)
 Power supply
 [EN81-20:2014 5.2.1.5.1. c)
 Light switch
 commuted with the cabinet.
 [EN81-20:2014 5.2.1.5.1. d)

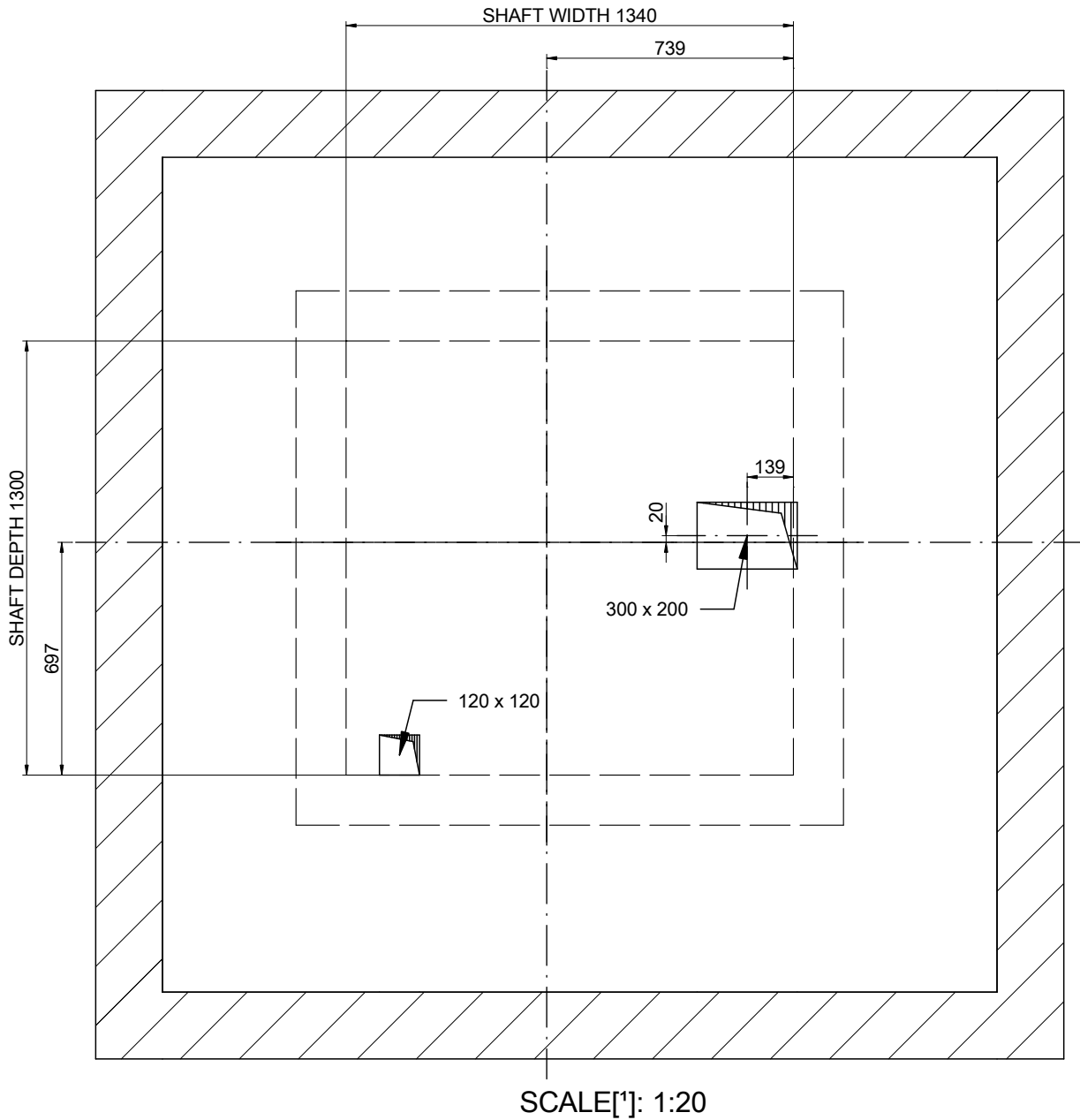
04-SLAB LAYOUT



DRAWING	DATE	REV.	SHEET	[*] Unbounded dimensions in drawings are indicative and not binding.	
MP	2017	00	3/7	REFERENCE: MPGO!FLEXLLATERAL375C_EN	
MODEL LIFT:				CLIENT:	MP LIFTS
MP GO! FLEX XL				WORK SITUATION:	
CAPACITY: [N° PERSONS]			5		
NOMINAL LOAD: [kg]			375		
SPEED: [m/s]			1		
FREQUENCY: [Hz]			50		
TENSION: [V]		380V [Three-phase]			

04B-MACHINE ROOM

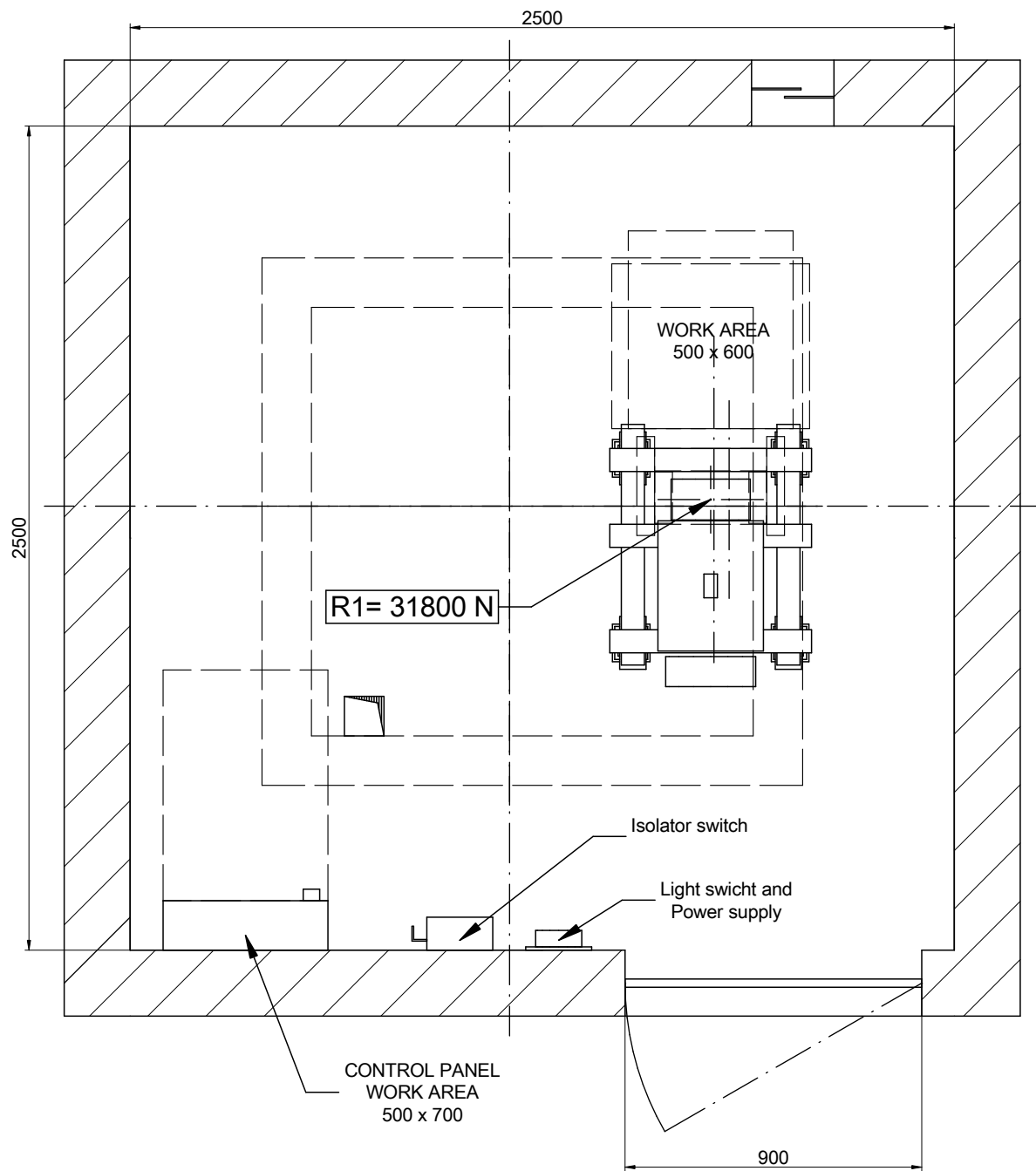

SCALE[*]: 1:20

Minimum machine room height: 2100 mm.
 [EN 81-20:2014 5.2.6.3.2.1]
 Minimum clearance door: 600x2000 mm.
 [EN 81-20:2014 5.2.3.2 a]

DRAWING	DATE	REV.	SHEET	[*] Unbounded dimensions in drawings are indicative and not binding.	
MP	2017	00	4/7	REFERENCE: MPGO!FLEXLLATERAL375C_EN	
MODEL LIFT:				CLIENT:	<p>MP LIFTS</p>
MP GO! FLEX XL				WORK SITUATION:	
CAPACITY: [N° PERSONS]			5		
NOMINAL LOAD: [kg]			375		
SPEED: [m/s]			1		
FREQUENCY: [Hz]			50		
TENSION: [V]		380V [Three-phase]			

05-PIT LAYOUT

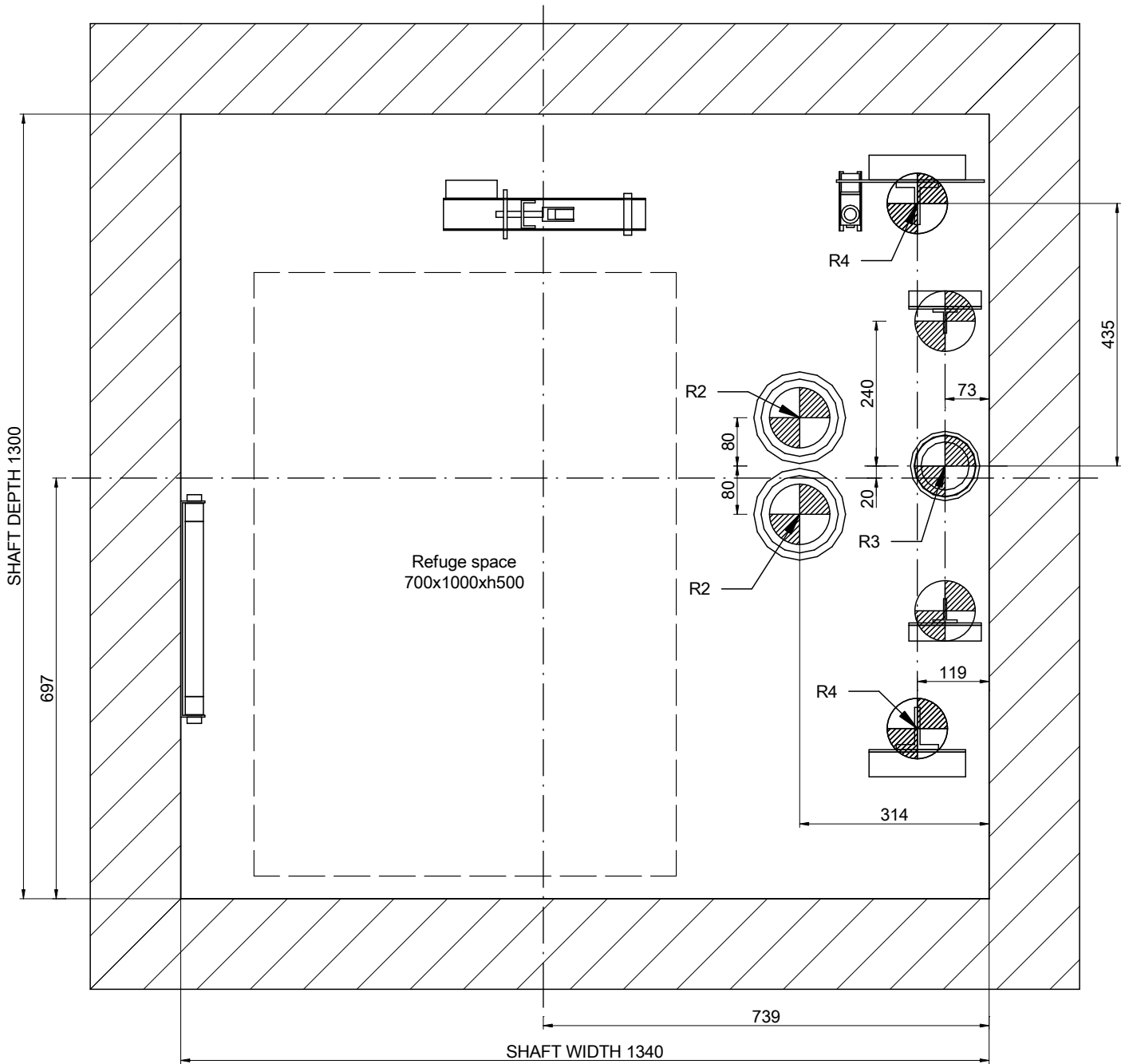

SCALE[*]: 1:10

REACTIONS [N] [max.]			
R2	22800		
R3	36700	R4 13500	
Sx	2300	Sy 720	

DRAWING	DATE	REV.	SHEET
MP	2017	00	5/7
MODEL LIFT:			
MP GO! FLEX XL			
CAPACITY: [N° PERSONS]	5		
NOMINAL LOAD: [kg]	375		
SPEED: [m/s]	1		
FREQUENCY: [Hz]	50		
TENSION: [V]	380V [Three-phase]		

[*] Unbounded dimensions in drawings are indicative and not binding.

REFERENCE:
MPGO!FLEXLLATERAL375C_EN



CLIENT:
WORK SITUATION:

MP LIFTS

06-DOOR HOLE DETAIL

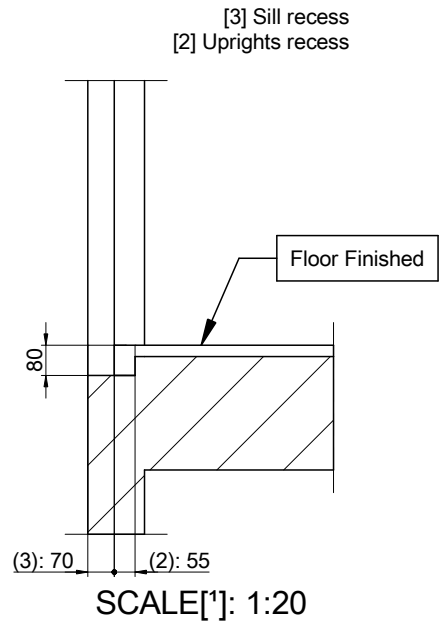
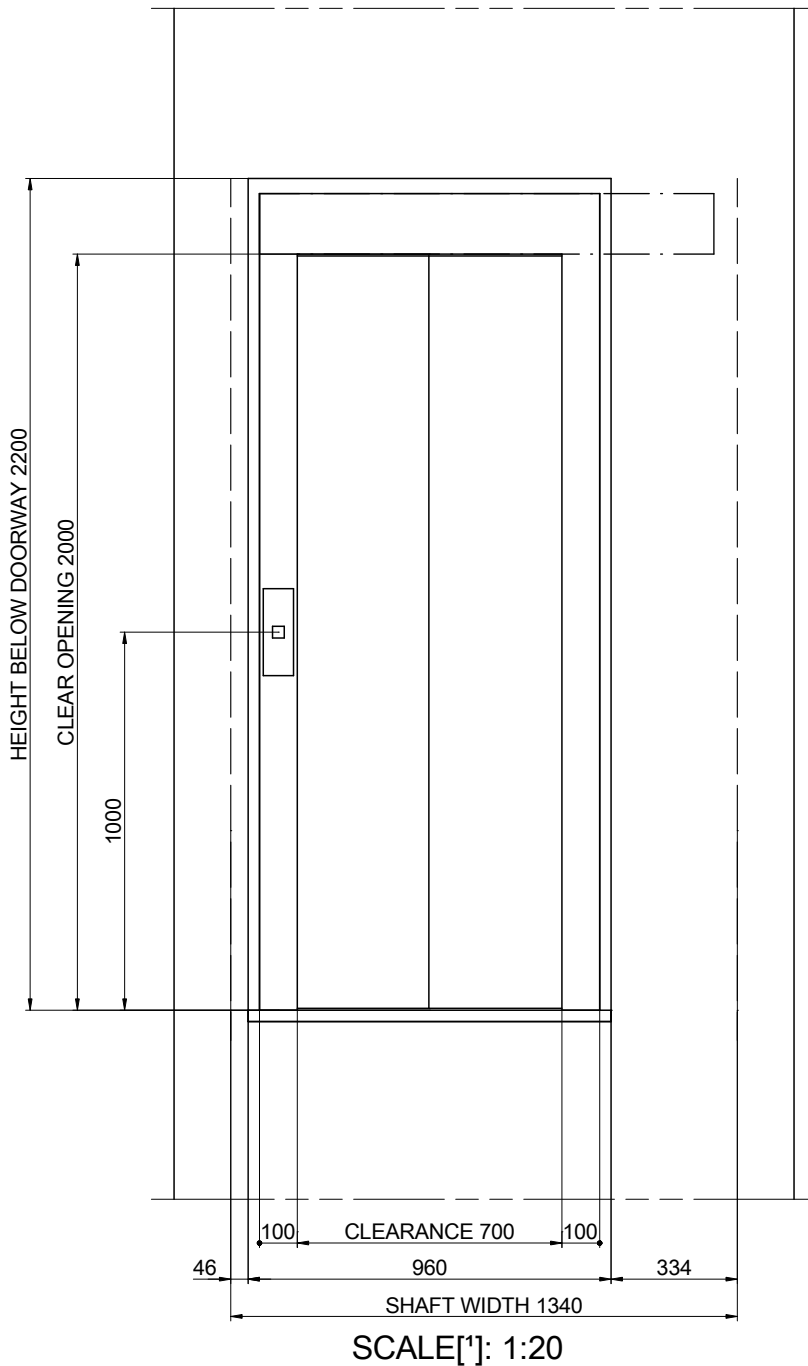

DRAWING	DATE	REV.	SHEET	[*] Unbounded dimensions in drawings are indicative and not binding.	
MP	2017	00	6/7	REFERENCE: MPGO!FLEXLLATERAL375C_EN	
MODEL LIFT:				CLIENT: WORK SITUATION:	
MP GO! FLEX XL					
CAPACITY: [N° PERSONS]			5		
NOMINAL LOAD: [kg]			375		
SPEED: [m/s]			1		
FREQUENCY: [Hz]			50		
TENSION: [V]		380V [Three-phase]		MP LIFTS	

07-HEADROOM

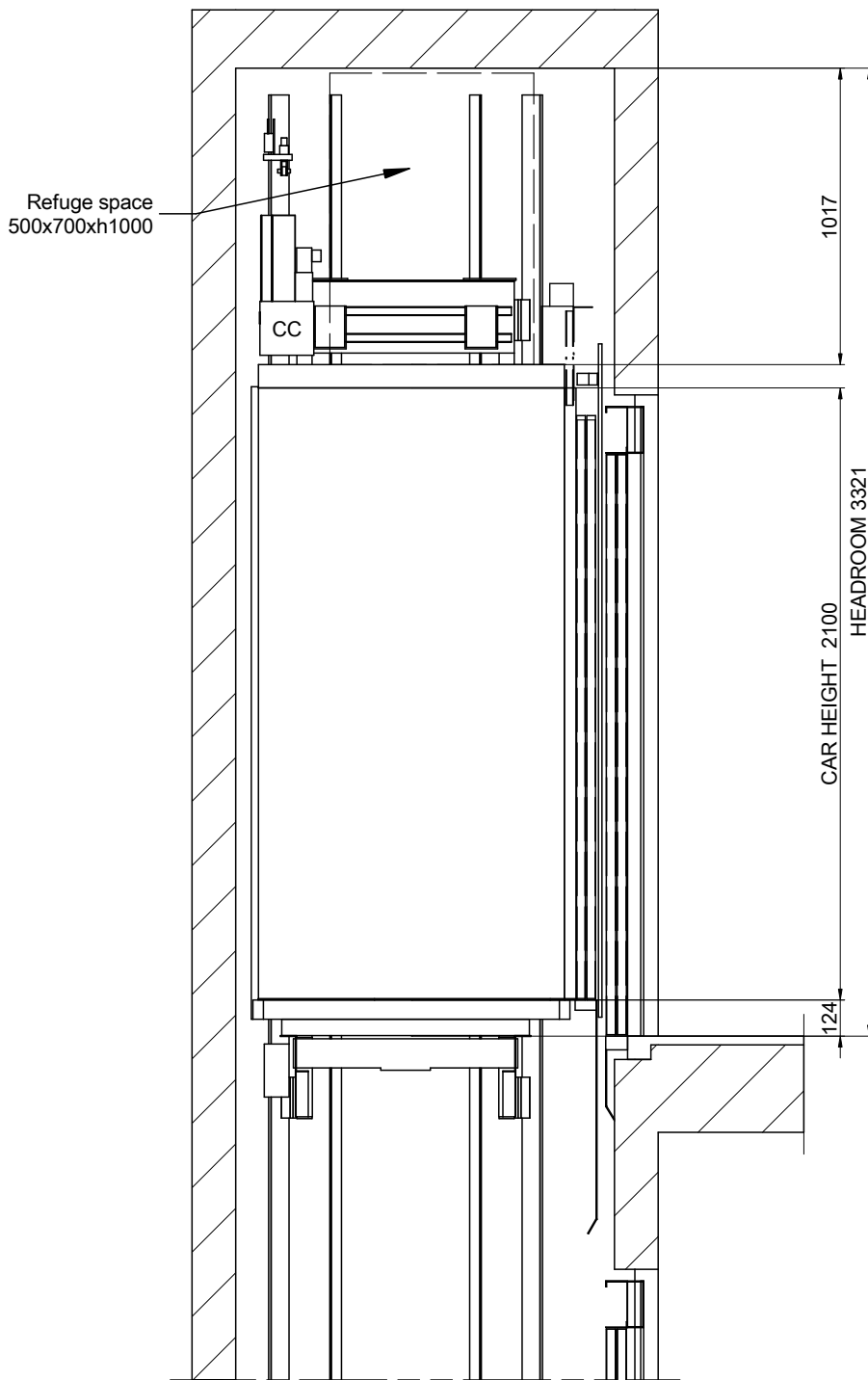

SCALE[*]: 1:25

DRAWING	DATE	REV.	SHEET	[*] Unbounded dimensions in drawings are indicative and not binding.	
MP	2017	00	7/7	REFERENCE: MPGO!FLEXLLATERAL375C_EN	
MODEL LIFT:				CLIENT: WORK SITUATION:	<p style="text-align: center; font-size: 2em; font-weight: bold;">MP LIFTS</p>
MP GO! FLEX XL					
CAPACITY: [N° PERSONS]			5		
NOMINAL LOAD: [kg]			375		
SPEED: [m/s]			1		
FREQUENCY: [Hz]			50		
TENSION: [V]		380V [Three-phase]			