

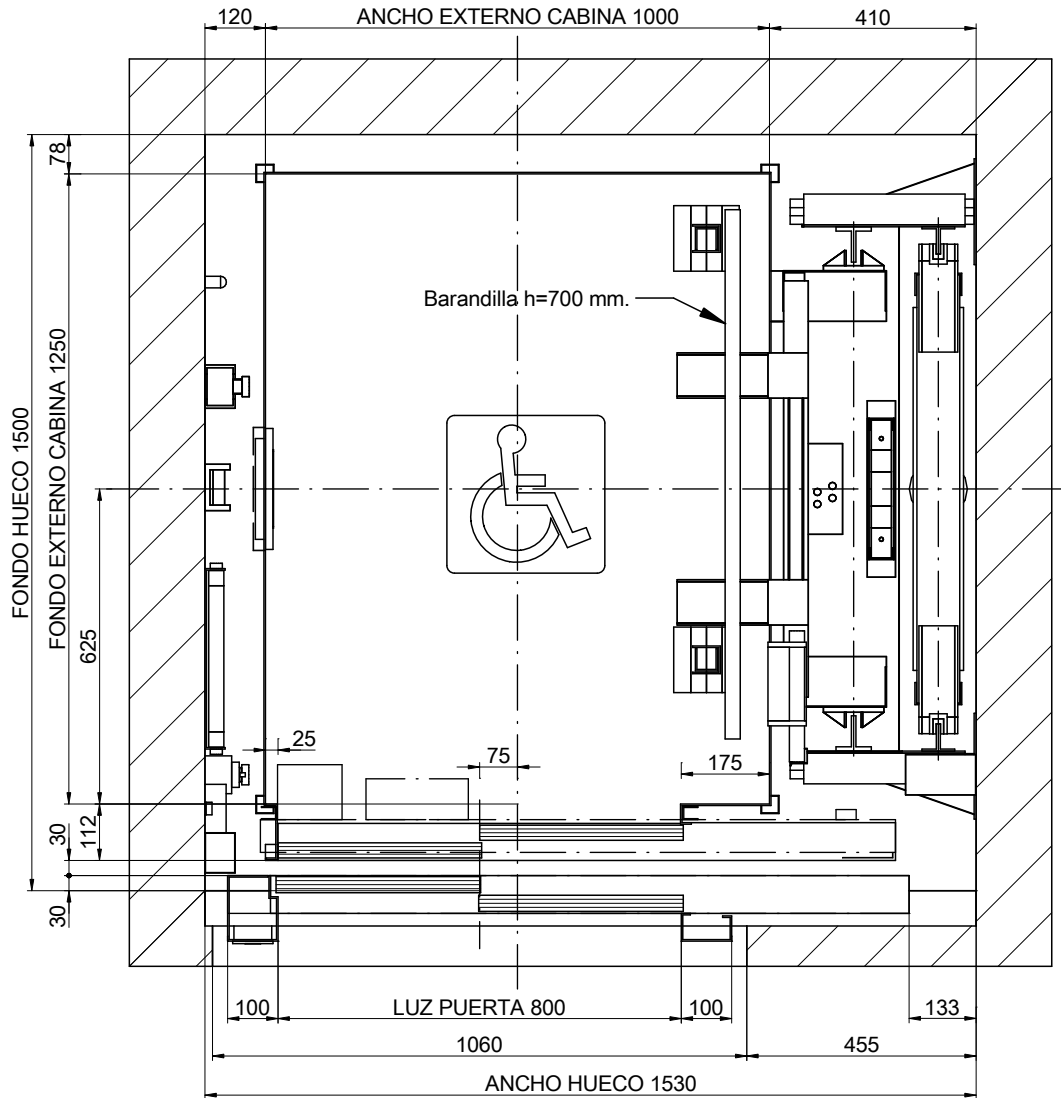

01-PLANTA



ESCALA[*]: 1:15

DIBUJADO	FECHA	REV.	HOJA	[*] Las dimensiones no acotadas en el plano son indicativas y no vinculantes.	
MP	2016	00	1/8		
MODELO ASCENSOR:				REFERENCIA:	
MP GO! FLEX				MPGO!FLEXLATERAL480S_ES	
CAPACIDAD: [Nº PERSONAS]				6	CLIENTE:
CARGA UTIL: [kg]				480	SITUACION OBRA:
VELOCIDAD: [m/s]				1	
FRECUENCIA: [Hz]				50	
TENSION: [V]				380V [Trifásica]	MP ASCENSORES

01B-PLANTA

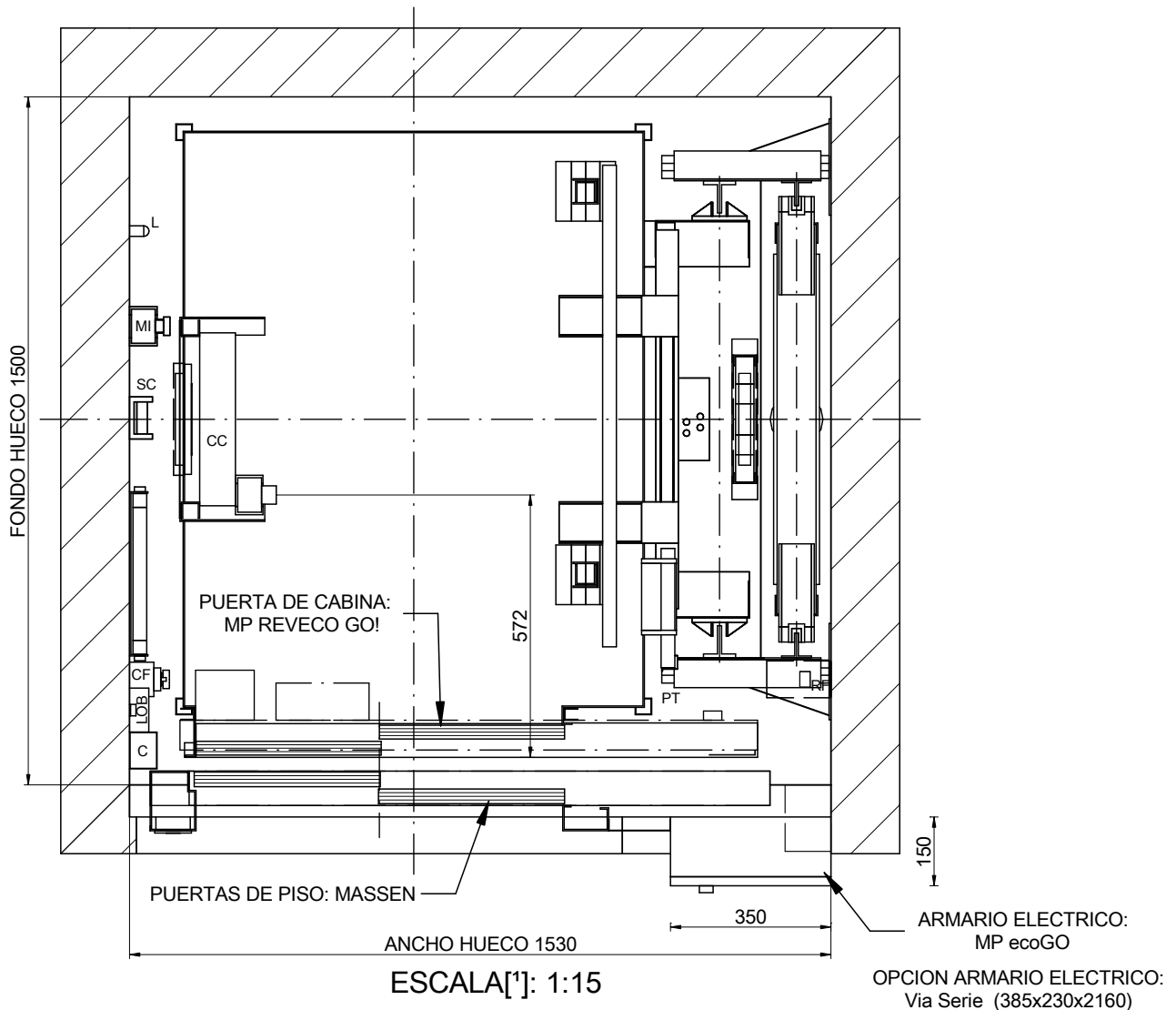

NOMENCLATURA

- C: Canaleta
- CC: Caja conexiones techo cabina
- CF: Caja foso
- CL: Conmutador Luz Hueco
- DOC: Caja Control Operador
- L: Luminaria
- LOB: Placa Control Botoneras
- MI: Mando Inspección
- PT: Patín
- RF: Resistencia Frenado
- ST: Dispositivo parada
- SC: Soporte cuerda maniobra

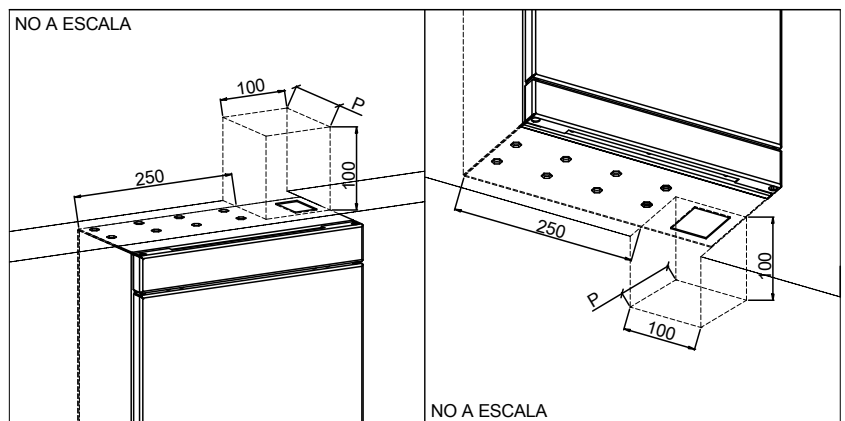

DIBUJADO	FECHA	REV.	HOJA	[*] Las dimensiones no acotadas en el plano son indicativas y no vinculantes.	
MP	2016	00	2/8		
MODELO ASCENSOR:				REFERENCIA:	
MP GO! FLEX				MPGO!FLEXLATERAL480S_ES	
CAPACIDAD: [Nº PERSONAS]				CLIENTE:	
6				SITUACION OBRA:	
CARGA UTIL: [kg]					
480					
VELOCIDAD: [m/s]					
1					
FRECUENCIA: [Hz]					
50					
TENSION: [V]					
380V [Trifásica]					

MP ASCENSORES

02-ALZADO LATERAL

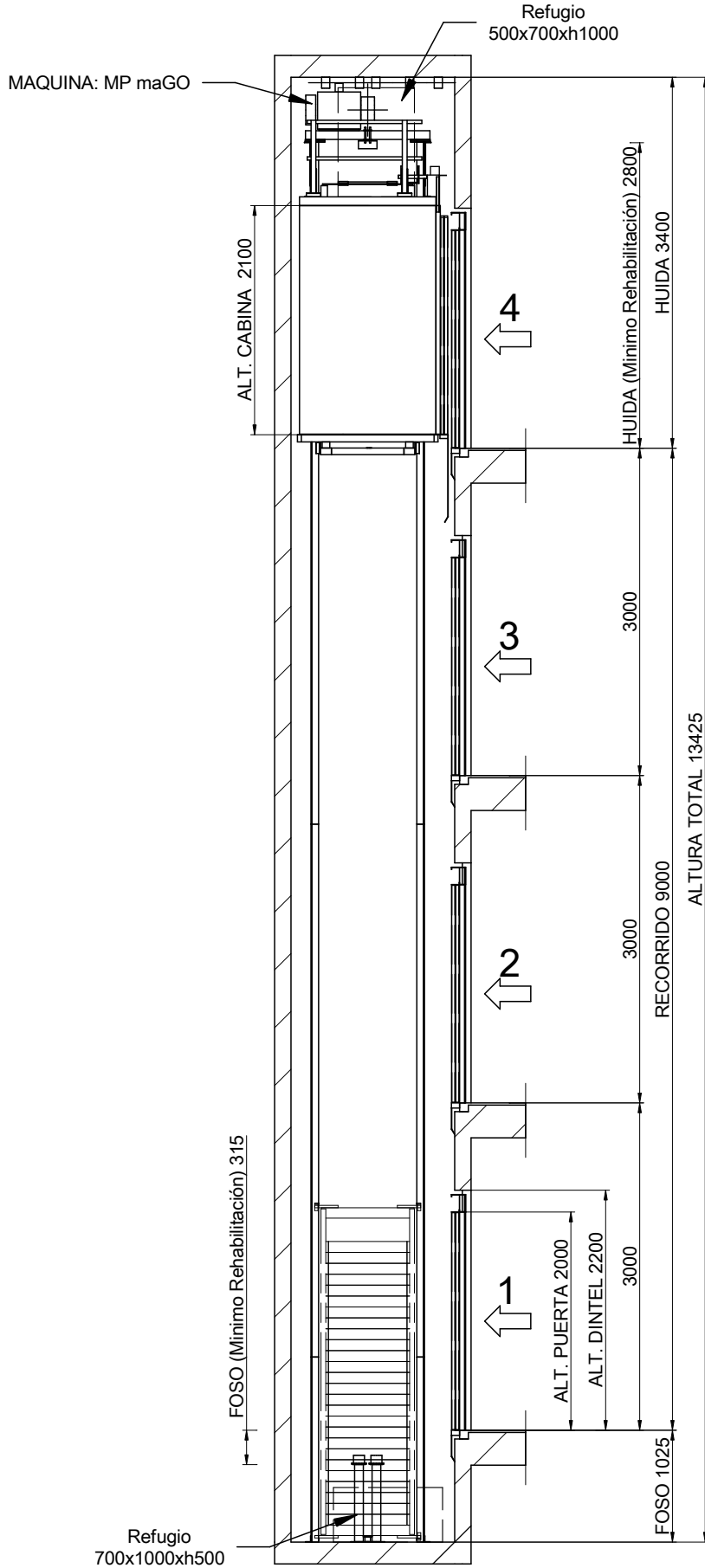

ESCALA[*]: 1:60

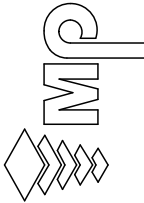
					
DIBUJADO	FECHA	REV.	HOJA	[*] Las dimensiones no acotadas en el plano son indicativas y no vinculantes.	
MP	2016	00	3/8	REFERENCIA:	MPGOIFLEXLATERAL480S_ES
MODELO ASCENSOR:	MP GO! FLEX				
CAPACIDAD: [N° PERSONAS]	6				
CARGA UTIL: [kg]	480				
VELOCIDAD: [m/s]	1				
FRECUENCIA: [Hz]	50				
TENSION: [V]	380V [Trifásica]				
				CLIENTE:	
				SITUACION OBRA:	
				MP ASCENSORES	

Foso liso y a nivel protegido de infiltraciones de agua.
 [EN81-20:2014 5.2.1.9]
 Prever dispositivo de acceso.
 [EN81-20:2014 5.2.2.4]
 Dispositivo de parada.
 [EN81-20:2014 5.2.1.5.1. a)
 Estación de control de inspección.
 [EN81-20:2014 5.2.1.5.1 b)
 Toma de corriente.
 [EN81-20:2014 5.2.1.5.1. c)
 Interruptor de alumbrado, conmutado con el armario.
 [EN81-20:2014 5.2.1.5.1. d)

03B-DETALLES DE FIJACION EN LA HUIDA

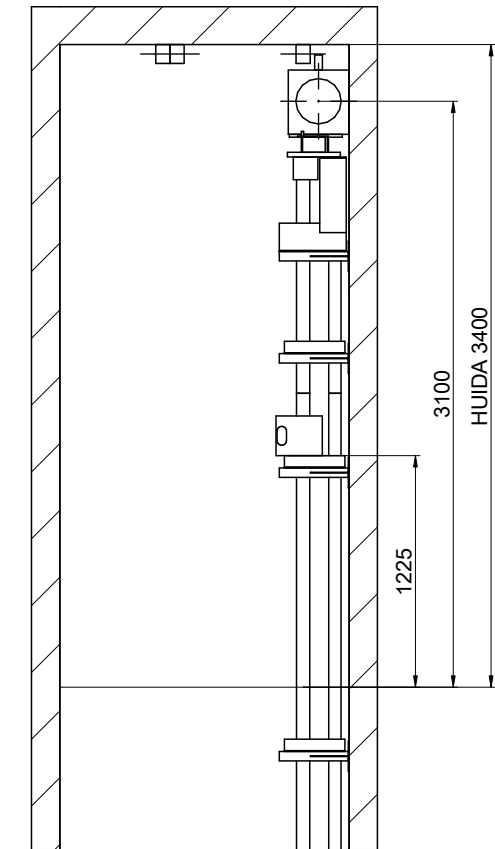

ESCALA[*]: 1:40

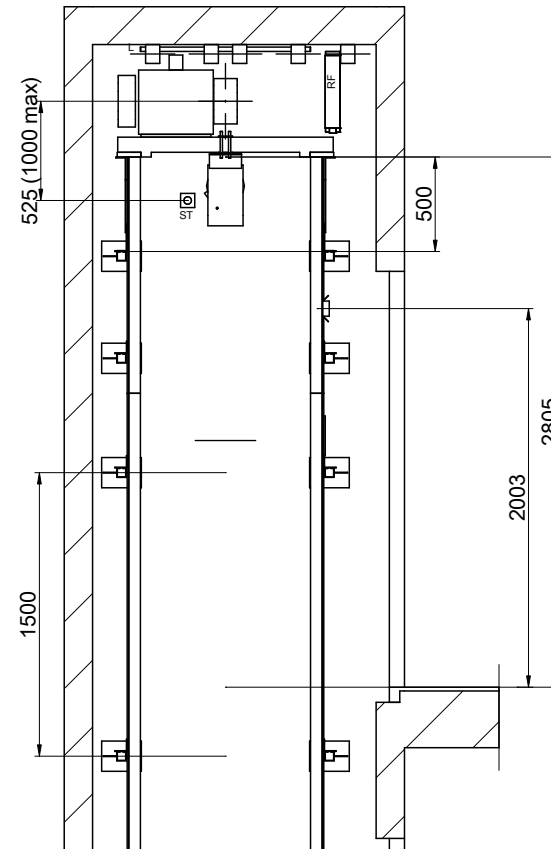



ESCALA[*]: 1:40

DIBUJADO	FECHA	REV.	HOJA	[*] Las dimensiones no acotadas en el plano son indicativas y no vinculantes.	
MP	2016	00	4/8		
MODELO ASCENSOR:				REFERENCIA:	
MP GO! FLEX				MPGO!FLEXLATERAL480S_ES	
CAPACIDAD: [Nº PERSONAS]				CLIENTE:	
6				SITUACION OBRA:	
CARGA UTIL: [kg]					
480					
VELOCIDAD: [m/s]					
1					
FRECUENCIA: [Hz]					
50					
TENSION: [V]					
380V [Trifásica]				MP ASCENSORES	

04-VIGA Y GANCHOS DE MONTAJE

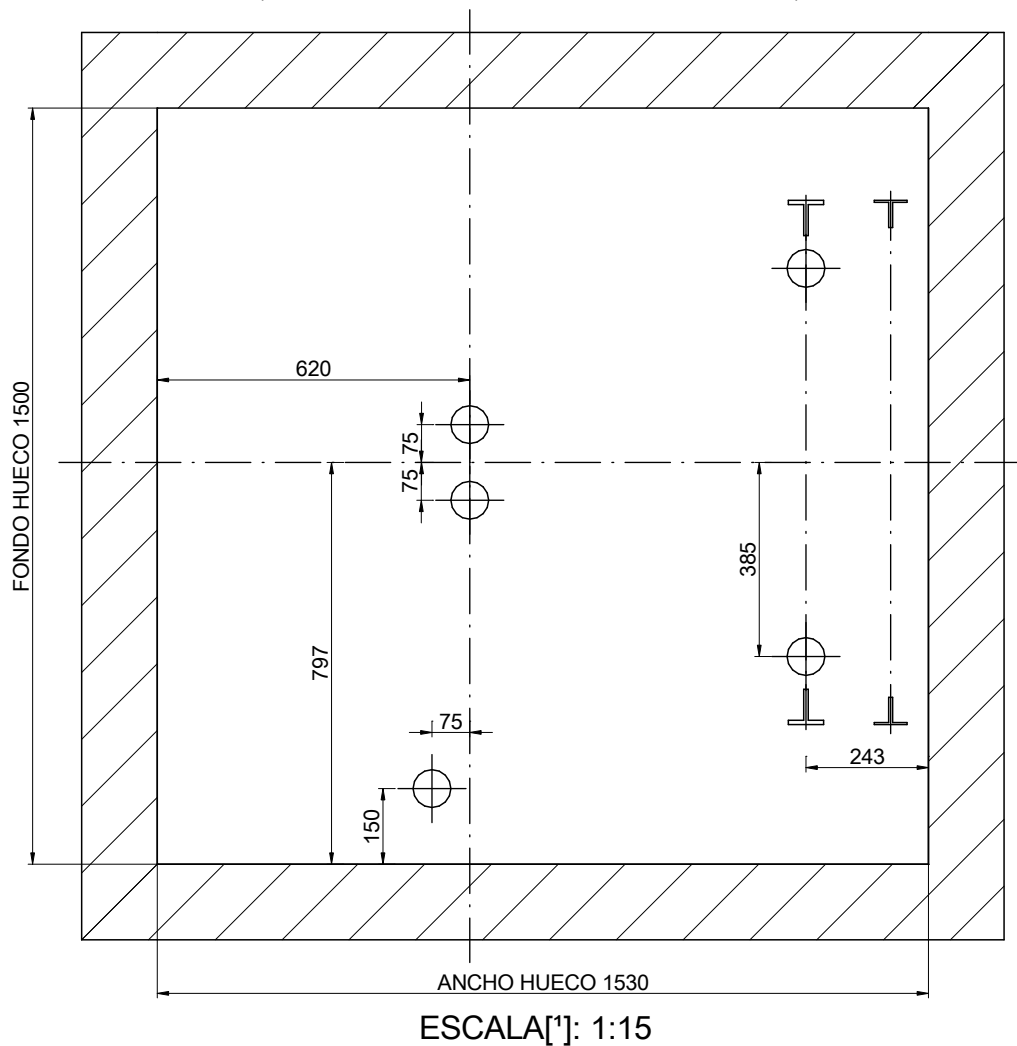
POSICION DE LOS GANCHOS DESMONTABLES CAPACES DE SOPORTAR
1000 kg CADA UNO A SUMINISTRAR POR EL CONSTRUCTOR
(POSICION RECOMENDADA GANCHOS DE MONTAJE)

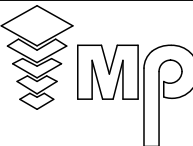

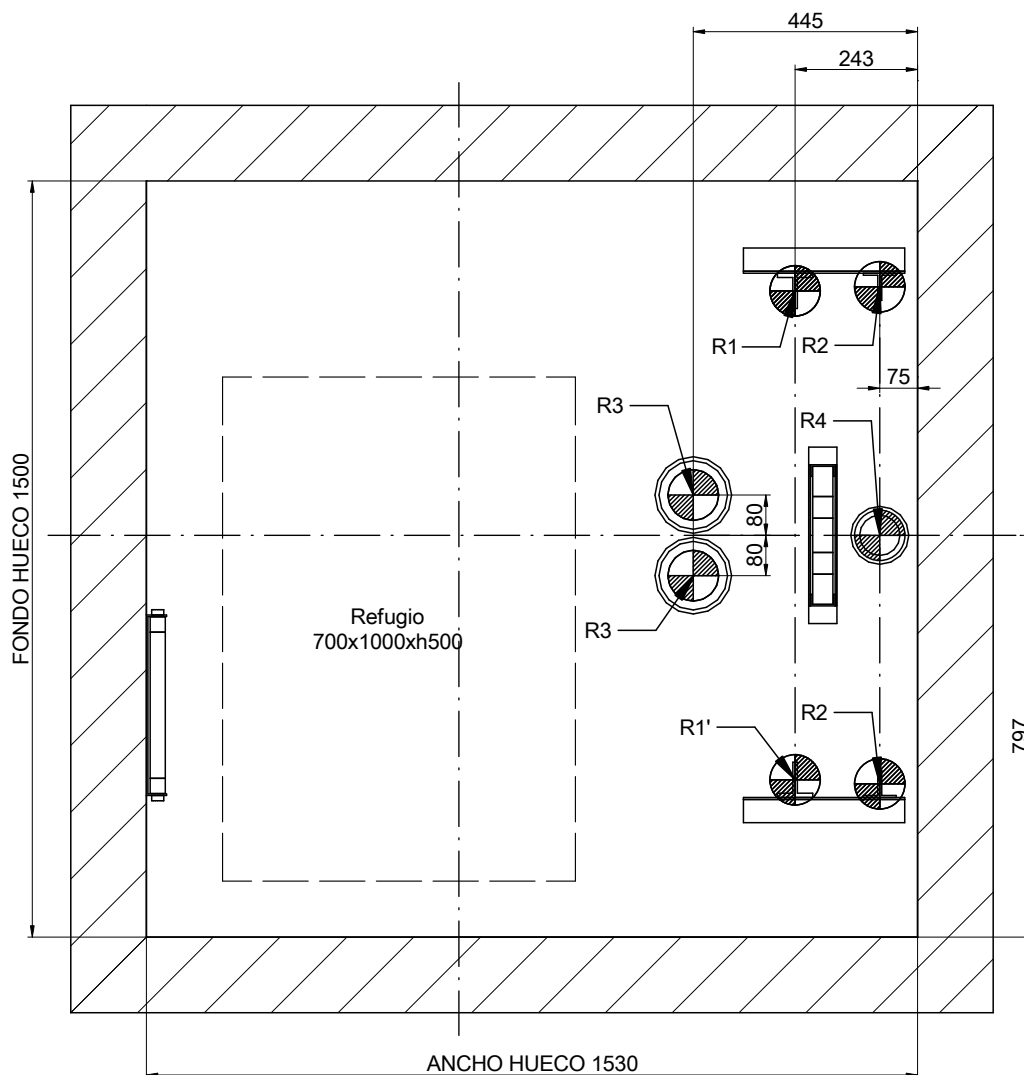

DIBUJADO	FECHA	REV.	HOJA	[*] Las dimensiones no acotadas en el plano son indicativas y no vinculantes.	
MP	2016	00	5/8	REFERENCIA: MPGOIFLEXLATERAL480S_ES	
MODELO ASCENSOR:				CLIENTE:	
MP GO! FLEX				SITUACION OBRA:	
CAPACIDAD: [N° PERSONAS]			6		
CARGA UTIL: [kg]			480		
VELOCIDAD: [m/s]			1		
FRECUENCIA: [Hz]			50		
TENSION: [V]			380V [Trifásica]		

05-PLANTA DE FOSO





ESCALA[*]: 1:15

REACCIONES [N] [max.]			
R1	25000	R2	1000
R1'	25000	R2'	1000
R3	25000	R4	20200
N	4500	T	1100

DIBUJADO	FECHA	REV.	HOJA	[*] Las dimensiones no acotadas en el plano son indicativas y no vinculantes.	
MP	2016	00	6/8		
MODELO ASCENSOR:				REFERENCIA:	
MP GO! FLEX				MPGO!FLEXLATERAL480S_ES	
CAPACIDAD: [Nº PERSONAS]				CLIENTE:	<p style="text-align: center;">MP ASCENSORES</p>
CARGA UTIL: [kg]				SITUACION OBRA:	
VELOCIDAD: [m/s]					
FRECUENCIA: [Hz]					
TENSION: [V]					

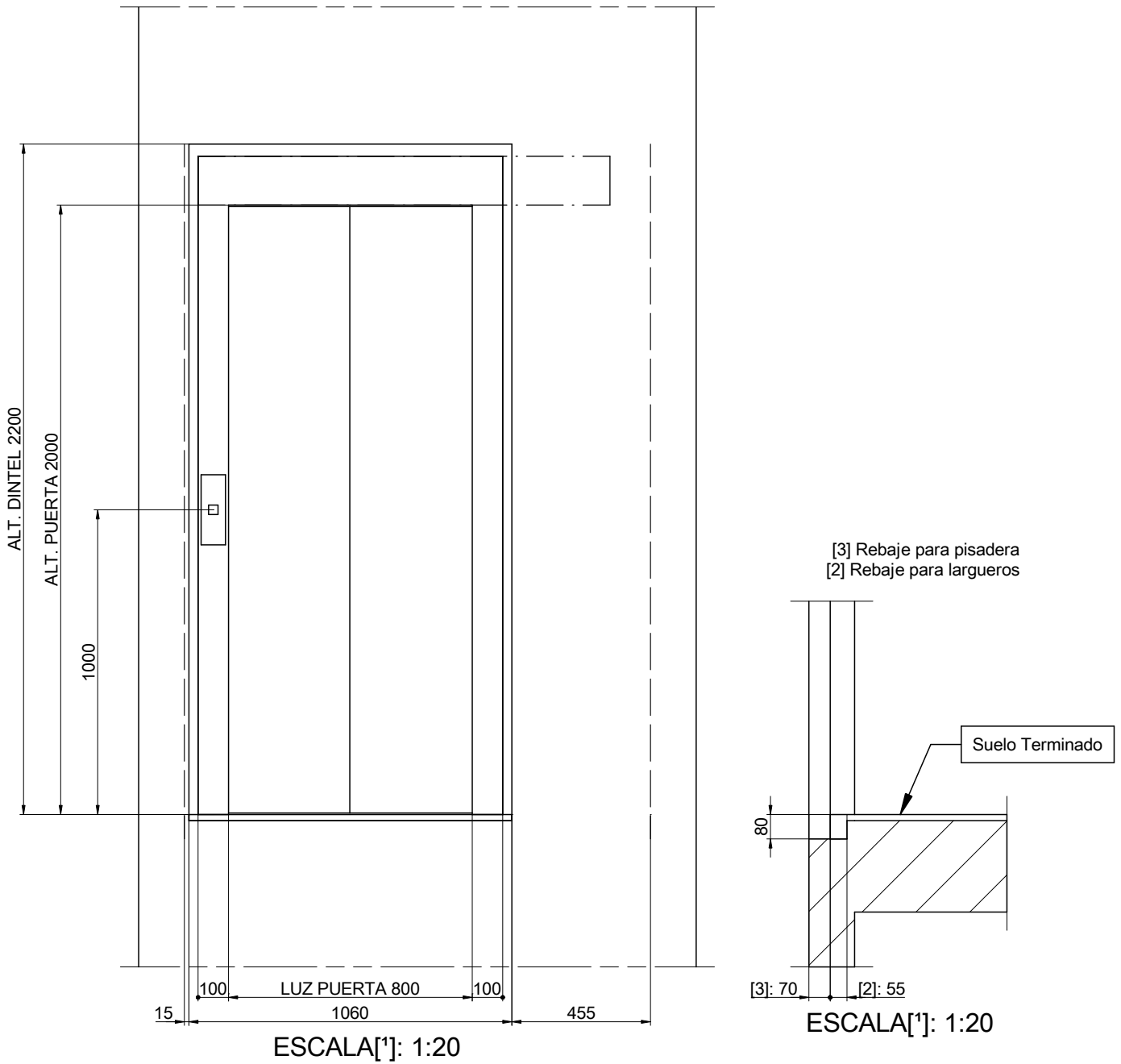
06-DETALLE DE HUECO DE PUERTA



DIBUJADO	FECHA	REV.	HOJA	[*] Las dimensiones no acotadas en el plano son indicativas y no vinculantes.	
MP	2016	00	7/8	REFERENCIA: MPGO!FLEXLATERAL480S_ES	
MODELO ASCENSOR:				CLIENTE:	
MP GO! FLEX				SITUACION OBRA:	
CAPACIDAD: [Nº PERSONAS]		6			
CARGA UTIL: [kg]		480			
VELOCIDAD: [m/s]		1			
FRECUENCIA: [Hz]		50			
TENSION: [V]		380V [Trifásica]		MP ASCENSORES	

07-HUIDA

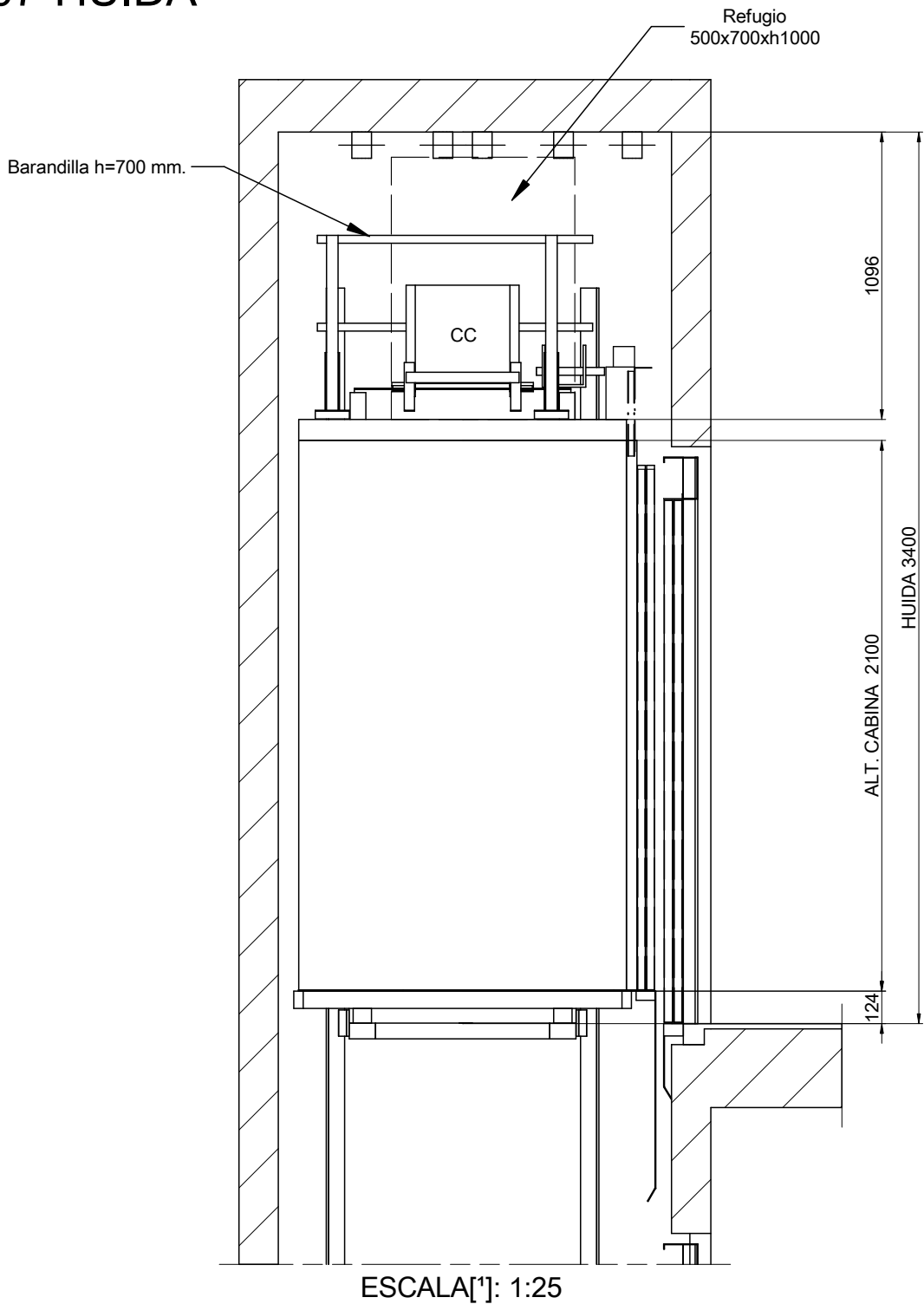

DIBUJADO	FECHA	REV.	HOJA	[*] Las dimensiones no acotadas en el plano son indicativas y no vinculantes.	
MP	2016	00	8/8	REFERENCIA: MPGO!FLEXLATERAL480S_ES	
MODELO ASCENSOR:				CLIENTE:	MP ASCENSORES
MP GO! FLEX				SITUACION OBRA:	
CAPACIDAD: [Nº PERSONAS]			6		
CARGA UTIL: [kg]			480		
VELOCIDAD: [m/s]			1		
FRECUENCIA: [Hz]			50		
TENSION: [V]		380V [Trifásica]			