

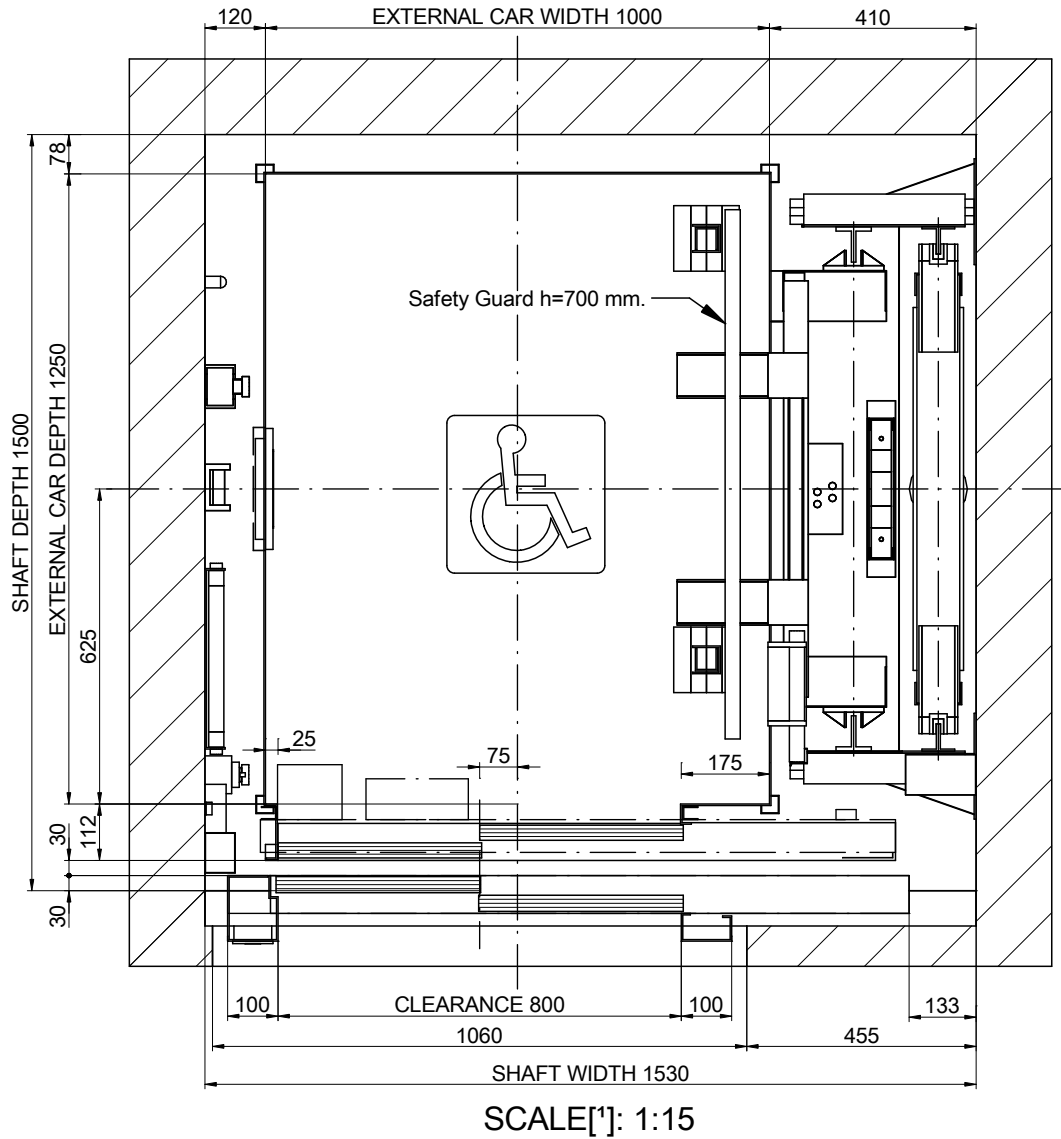

01-PLAN VIEW



DRAWING	DATE	REV.	SHEET	[*] Unbounded dimensions in drawings are indicative and not binding.	
MP	2016	00	1/8	REFERENCE: MPGOIFLEXLATERAL480S_EN	
MODEL LIFT:				CLIENT: WORK SITUATION:	<p style="text-align: center; font-size: 24px; font-weight: bold;">MP LIFTS</p>
MP GO! FLEX					
CAPACITY: [N° PERSONS]			6		
NOMINAL LOAD: [kg]			480		
SPEED: [m/s]			1		
FREQUENCY: [Hz]			50		
TENSION: [V]		380V [Three-phase]			

01B-PLAN VIEW

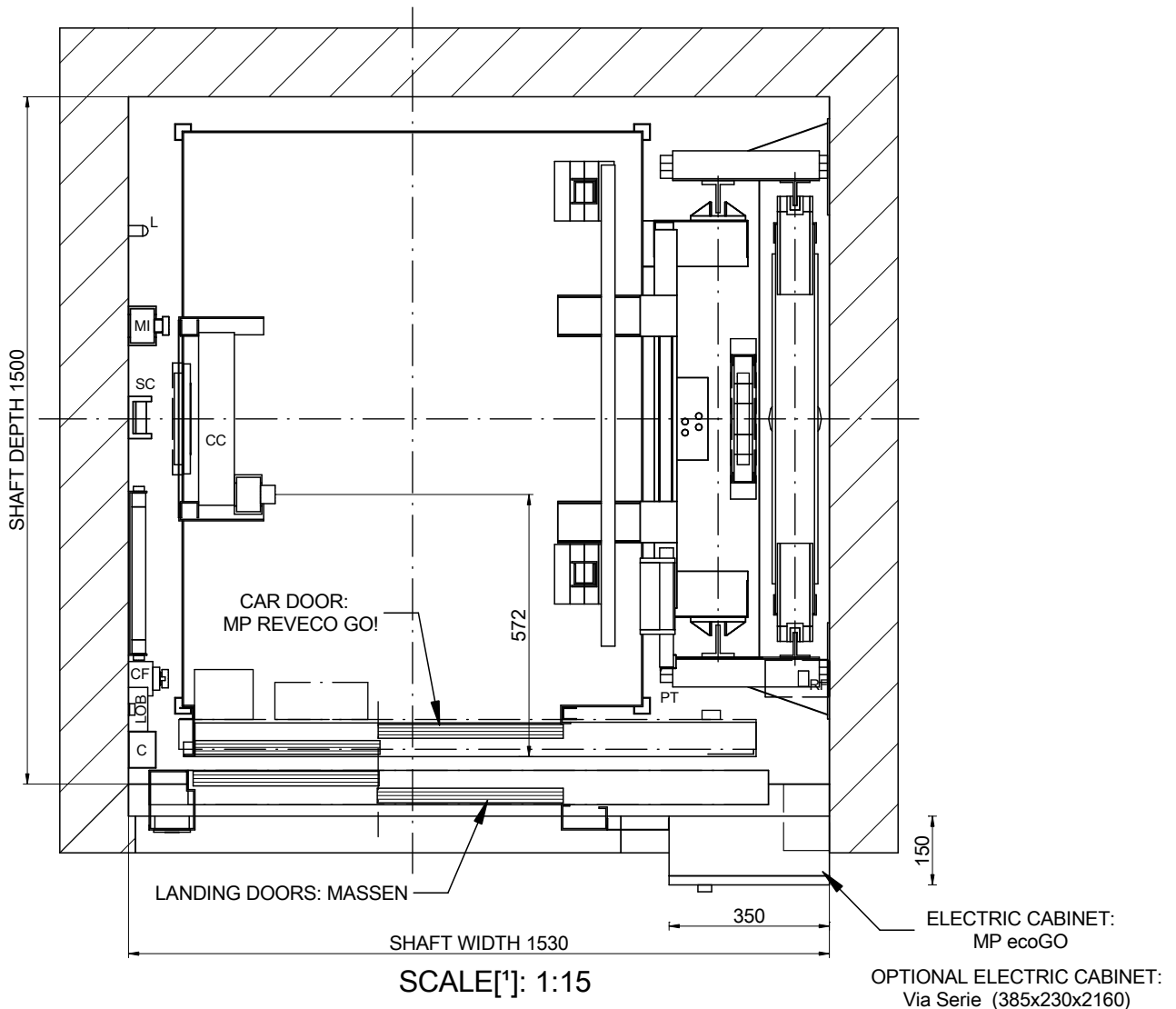

NOMENCLATURE

- C: Wiring channel
- CC: Car ceiling connection box
- CF: Pit box
- CL: Shaft light switch
- DOC: Operator control box
- L: Lamp
- LOB: Pushbutton control board
- MI: Inspection control station
- PT: Fixed cam
- RF: Brake resistor
- ST: Stopping device
- SC: Travelling cable support

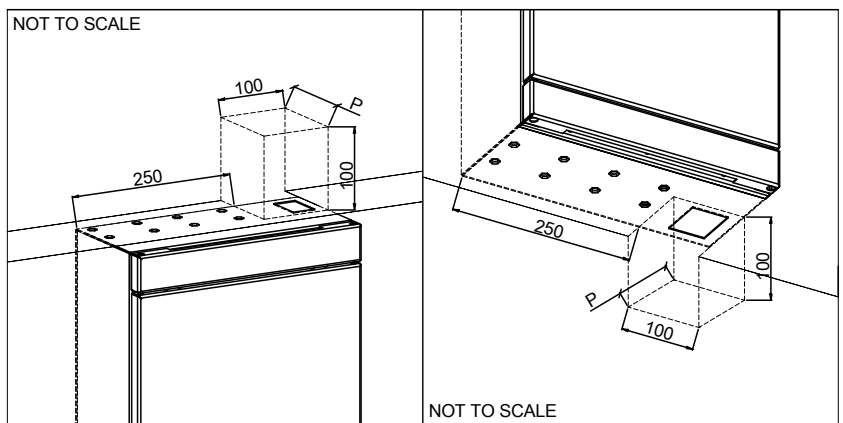

DRAWING	DATE	REV.	SHEET	[*] Unbounded dimensions in drawings are indicative and not binding.	
MP	2016	00	2/8		
MODEL LIFT:				REFERENCE:	
MP GO! FLEX				MPGO!FLEXLATERAL480S_EN	
CAPACITY: [N° PERSONS]				6	CLIENT:
NOMINAL LOAD: [kg]				480	WORK SITUATION:
SPEED: [m/s]				1	
FREQUENCY: [Hz]				50	
TENSION: [V]				380V [Three-phase]	MP LIFTS

02-SIDE VERTICAL SECTION

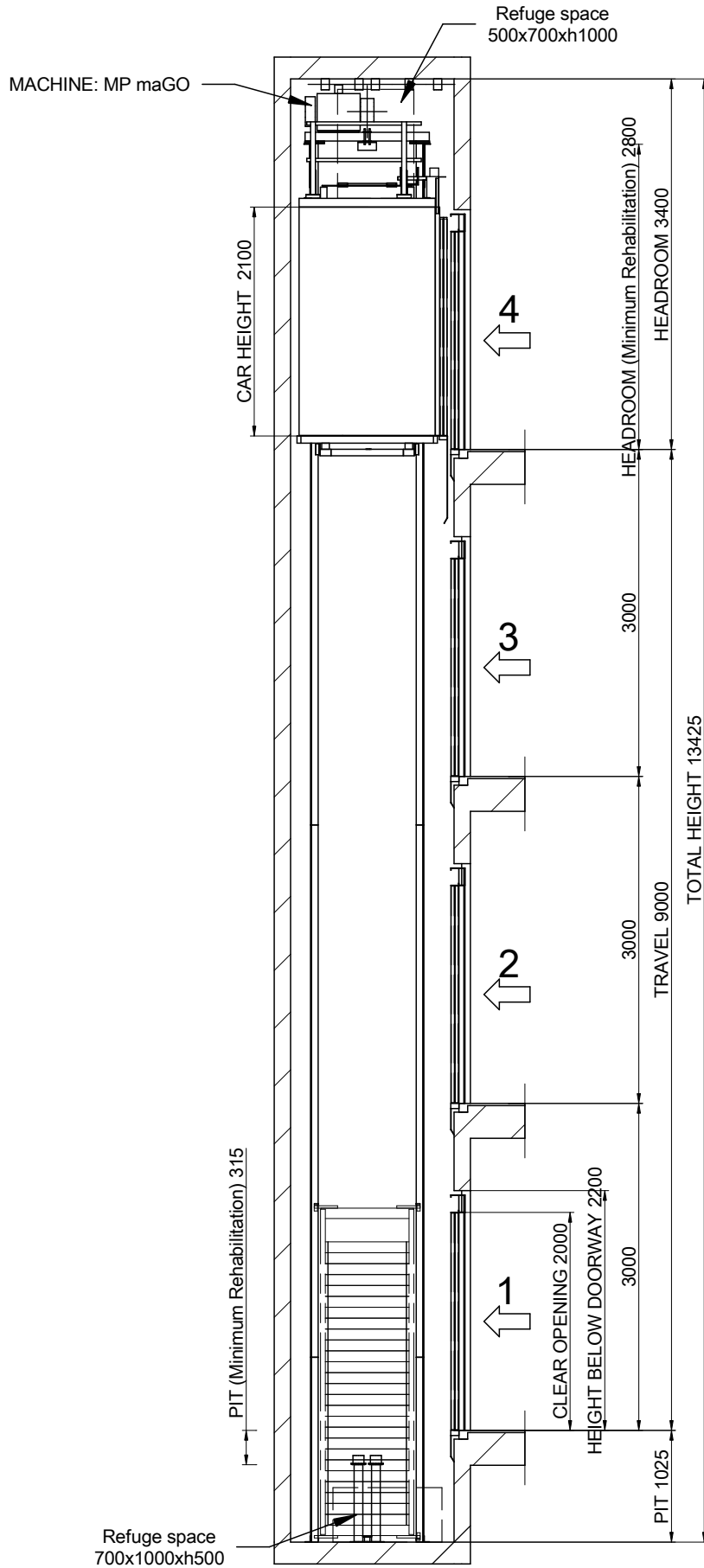

SCALE[*]: 1:60

DRAWING		DATE	REV.	SHEET	[!] Unbounded dimensions in drawings are indicative and not binding.
MP	2016	00	3/8	REFERENCE: MPGOIFLEXLATERAL480S_EN	
MODEL LIFT:		MP GO! FLEX			CLIENT: WORK SITUATION:
CAPACITY: [N° PERSONS]		6			
NOMINAL LOAD: [kg]		480			
SPEED: [m/s]		1			
FREQUENCY: [Hz]		50			
TENSION: [V]		380V [Three-phase]			MP LIFTS

Flat and levelled floor, protected against water leaking.
 [EN81-20:2014 5.2.1.9]
 Foresee pit access device
 [EN81-20:2014 5.2.2.4]
 Stop device
 [EN81-20:2014 5.2.1.5.1. a)
 Inspection control station.
 [EN81-20:2014 5.2.1.5.1. b)
 Power supply
 [EN81-20:2014 5.2.1.5.1. c)
 Light switch
 commuted with the cabinet.
 [EN81-20:2014 5.2.1.5.1. d)



03B-FIXING DETAILS IN HEADROOM

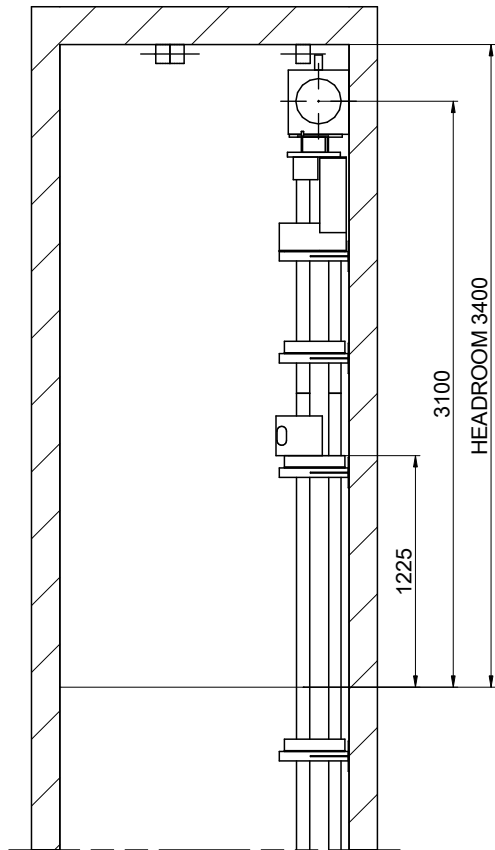

SCALE[*]: 1:40

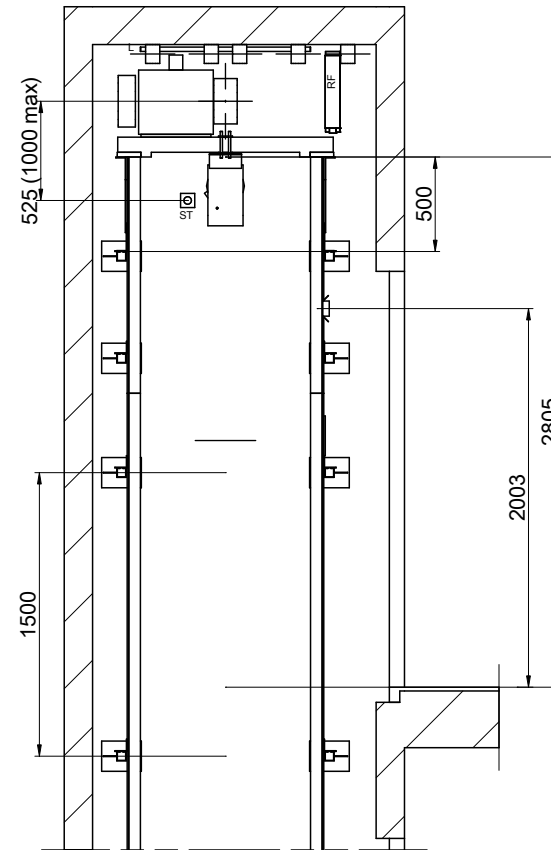



SCALE[*]: 1:40

DRAWING	DATE	REV.	SHEET	[*] Unbounded dimensions in drawings are indicative and not binding.	
MP	2016	00	4/8		
MODEL LIFT:				REFERENCE: MPGO!FLEXLATERAL480S_EN	
MP GO! FLEX				CLIENT:	
CAPACITY: [N° PERSONS]			6	WORK SITUATION:	
NOMINAL LOAD: [kg]			480		
SPEED: [m/s]			1		
FREQUENCY: [Hz]			50		
TENSION: [V]			380V [Three-phase]	MP LIFTS	

04-BEAM AND LIFTING HOOKS

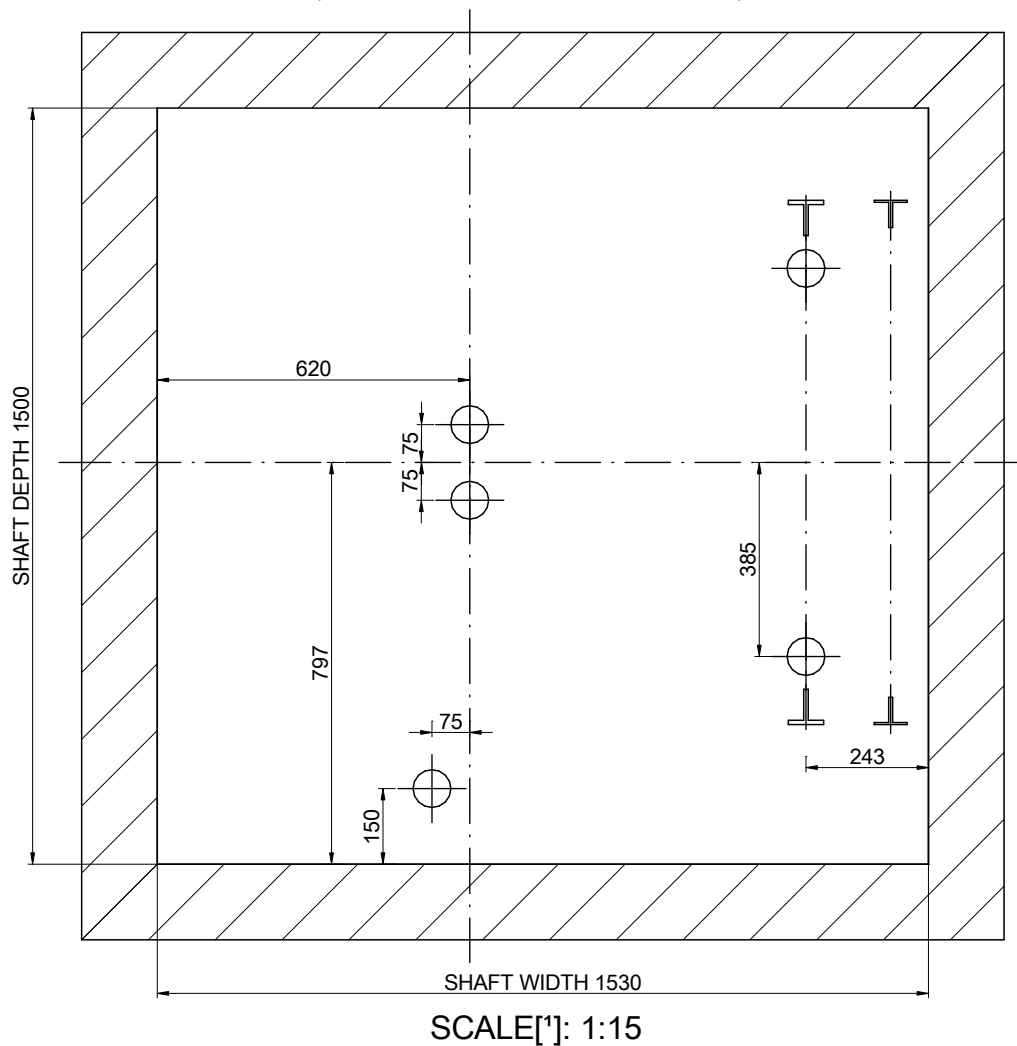
POSITION OF REMOVABLE LIFTING HOOKS ABLE TO SUPPORT
1000 kg EACH ONE SUPPLIED BY CONSTRUCTOR
(RECOMMENDED POSITION LOADHOOKS)



DRAWING	DATE	REV.	SHEET	[*] Unbounded dimensions in drawings are indicative and not binding.	
MP	2016	00	5/8	REFERENCE: MPGOIFLEXLATERAL480S_EN	
MODEL LIFT:				CLIENT:	WORK SITUATION:
MP GO! FLEX					
CAPACITY: [N° PERSONS]			6	<h2>MP LIFTS</h2>	
NOMINAL LOAD: [kg]			480		
SPEED: [m/s]			1		
FREQUENCY: [Hz]			50		
TENSION: [V]			380V [Three-phase]		

05-PIT LAYOUT

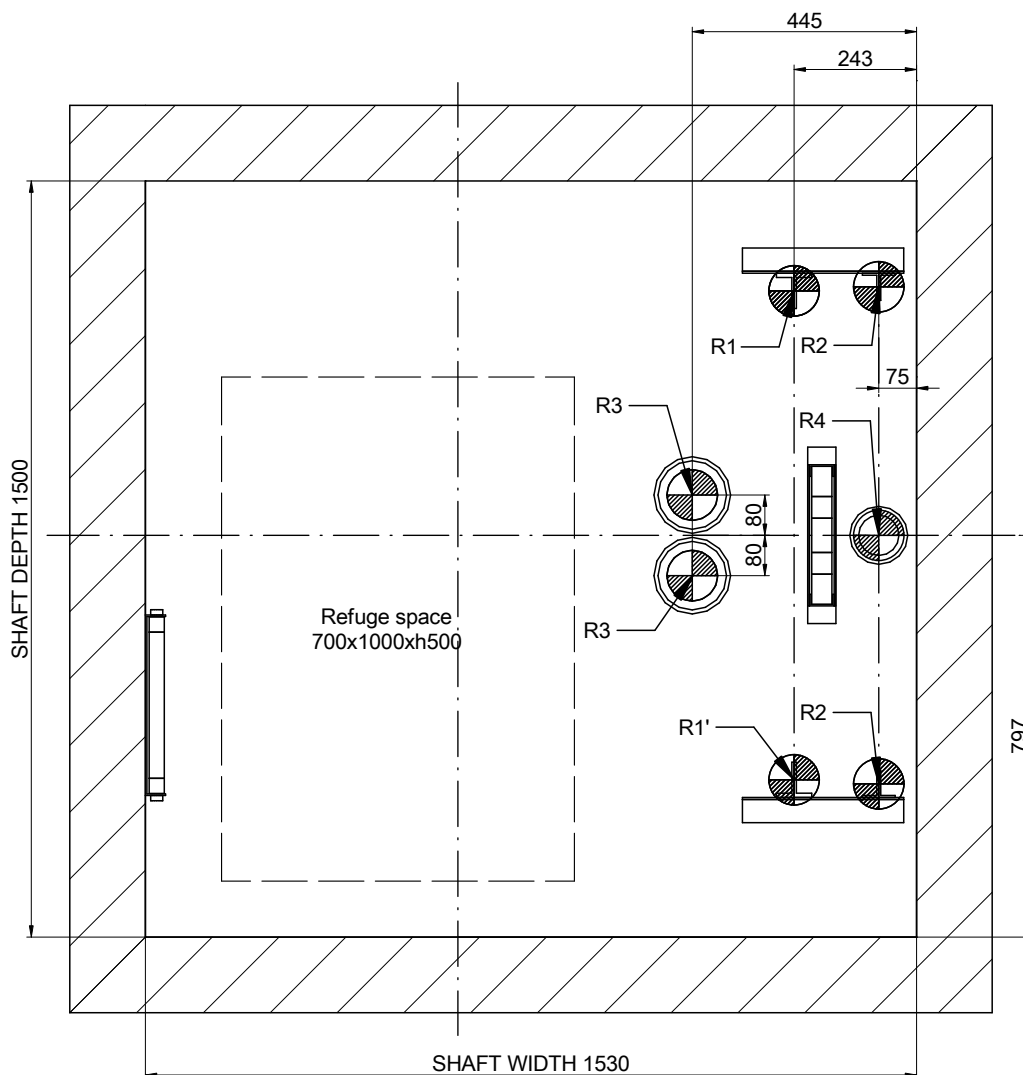

REACTIONS [N] [max.]			
R1	25000	R2	1000
R1'	25000	R2'	1000
R3	25000	R4	20200
N	4500	T	1100

DRAWING	DATE	REV.	SHEET	[*] Unbounded dimensions in drawings are indicative and not binding.	
MP	2016	00	6/8		
MODEL LIFT:				REFERENCE: MPGO!FLEXLATERAL480S_EN	CLIENT: WORK SITUATION:
MP GO! FLEX					
CAPACITY: [N° PERSONS]			6	<h2>MP LIFTS</h2>	
NOMINAL LOAD: [kg]			480		
SPEED: [m/s]			1		
FREQUENCY: [Hz]			50		
TENSION: [V]			380V [Three-phase]		

06-DOOR HOLE DETAIL

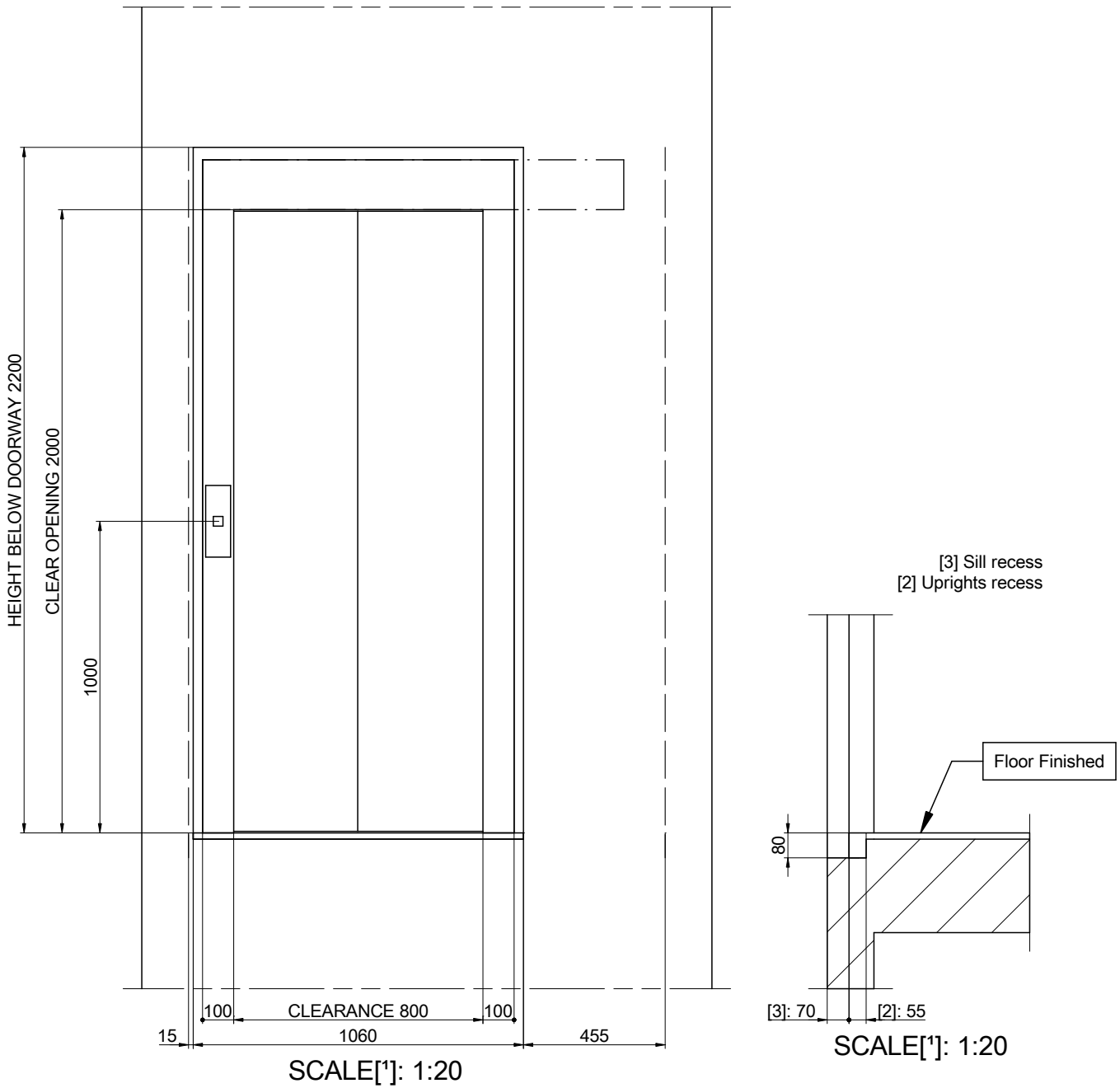

DRAWING	DATE	REV.	SHEET	[*] Unbounded dimensions in drawings are indicative and not binding.	
MP	2016	00	7/8	REFERENCE: MPGO!FLEXLATERAL480S_EN	
MODEL LIFT:				CLIENT:	WORK SITUATION:
MP GO! FLEX					
CAPACITY: [N° PERSONS]			6	<p style="text-align: center; font-size: 2em; font-weight: bold;">MP LIFTS</p>	
NOMINAL LOAD: [kg]			480		
SPEED: [m/s]			1		
FREQUENCY: [Hz]			50		
TENSION: [V]			380V [Three-phase]		

07-HEADROOM

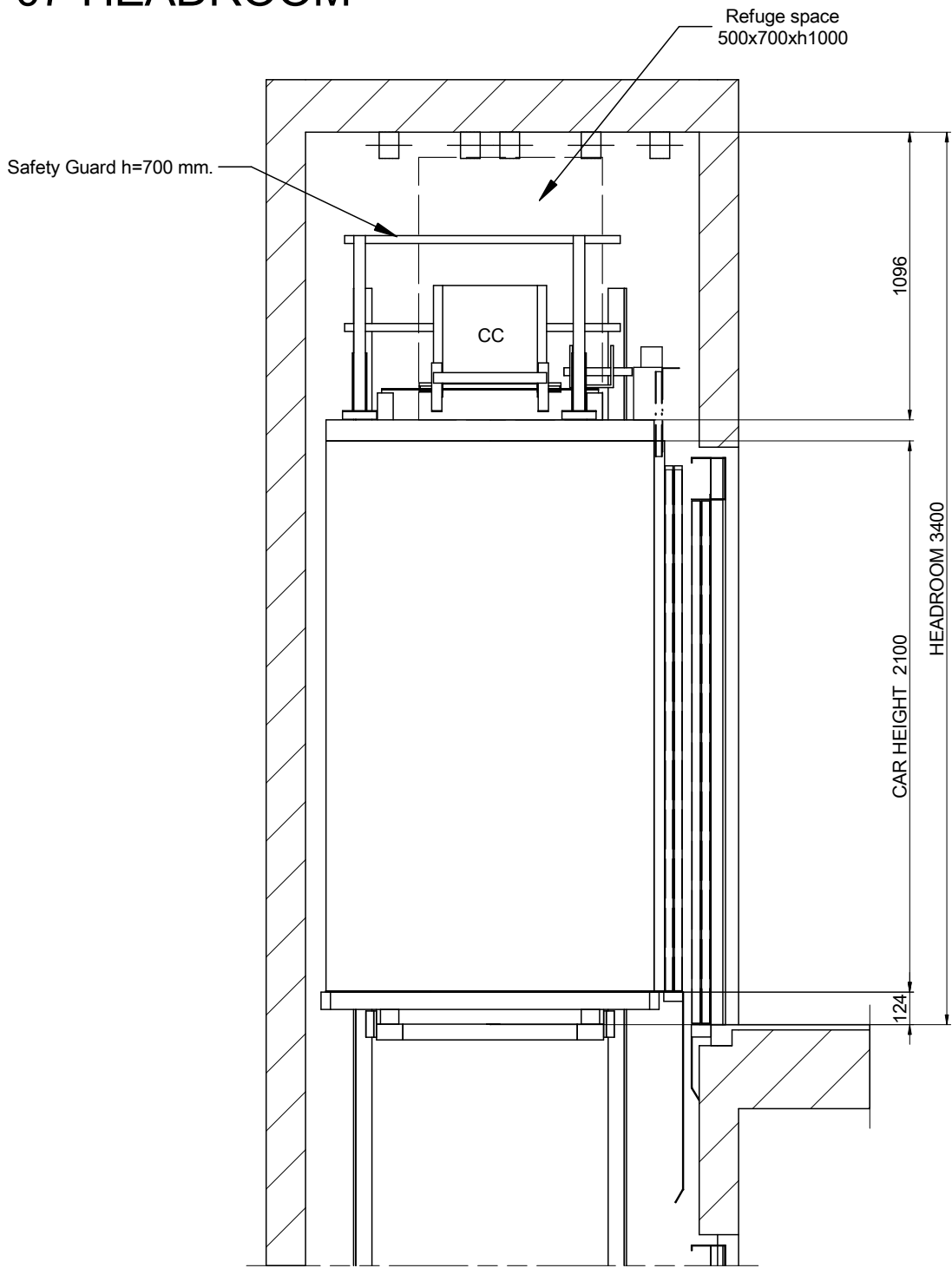

SCALE[*]: 1:25

DRAWING	DATE	REV.	SHEET	[*] Unbounded dimensions in drawings are indicative and not binding.	
MP	2016	00	8/8		
MODEL LIFT:				REFERENCE:	<p>CLIENT:</p> <p>WORK SITUATION:</p>
MP GO! FLEX				MPGO!FLEXLATERAL480S_EN	
CAPACITY: [N° PERSONS]			6		
NOMINAL LOAD: [kg]			480		
SPEED: [m/s]			1		
FREQUENCY: [Hz]			50		
TENSION: [V]			380V [Three-phase]		
				MP LIFTS	