

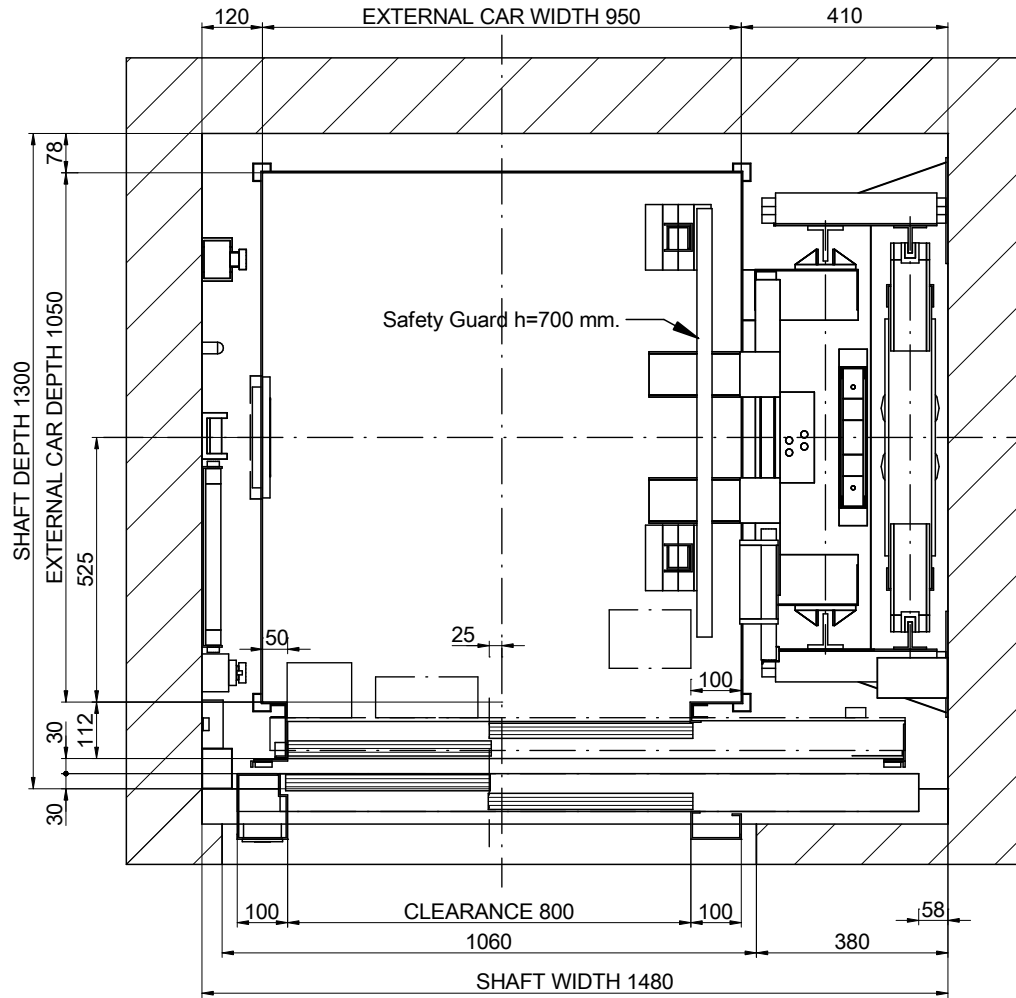

01-PLAN VIEW



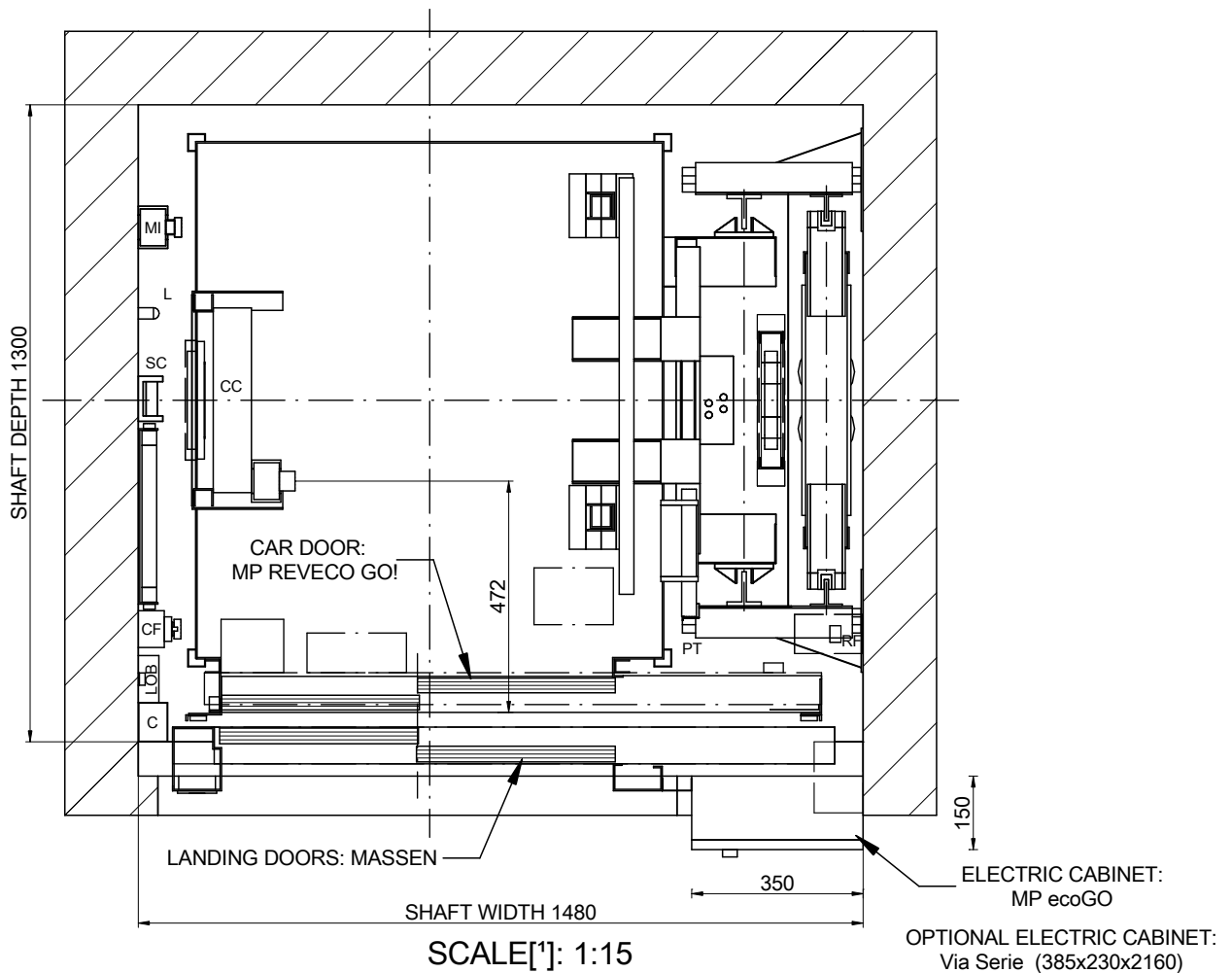

DRAWING	DATE	REV.	SHEET	[*] Unbounded dimensions in drawings are indicative and not binding.	
MP	2016	00	1/8	REFERENCE: MPGO!FLEXLATERAL375S_EN	
MODEL LIFT:				CLIENT:	MP LIFTS
MP GO! FLEX				WORK SITUATION:	
CAPACITY: [N° PERSONS]			5		
NOMINAL LOAD: [kg]			375		
SPEED: [m/s]			1		
FREQUENCY: [Hz]			50		
TENSION: [V]		380V [Three-phase]			

01B-PLAN VIEW



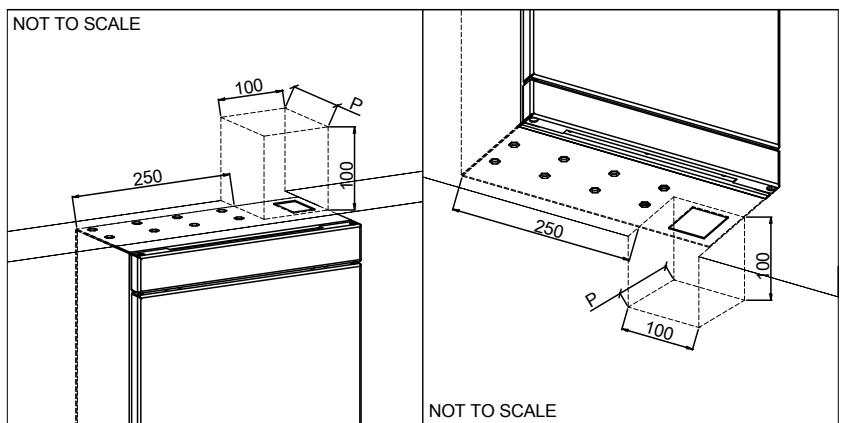

- NOMENCLATURE**
- C: Wiring channel
 - CC: Car ceiling connection box
 - CF: Pit box
 - CL: Shaft light switch
 - DOC: Operator control box
 - L: Lamp
 - LOB: Pushbutton control board
 - MI: Inspection control station
 - PT: Fixed cam
 - RF: Brake resistor
 - ST: Stopping device
 - SC: Travelling cable support

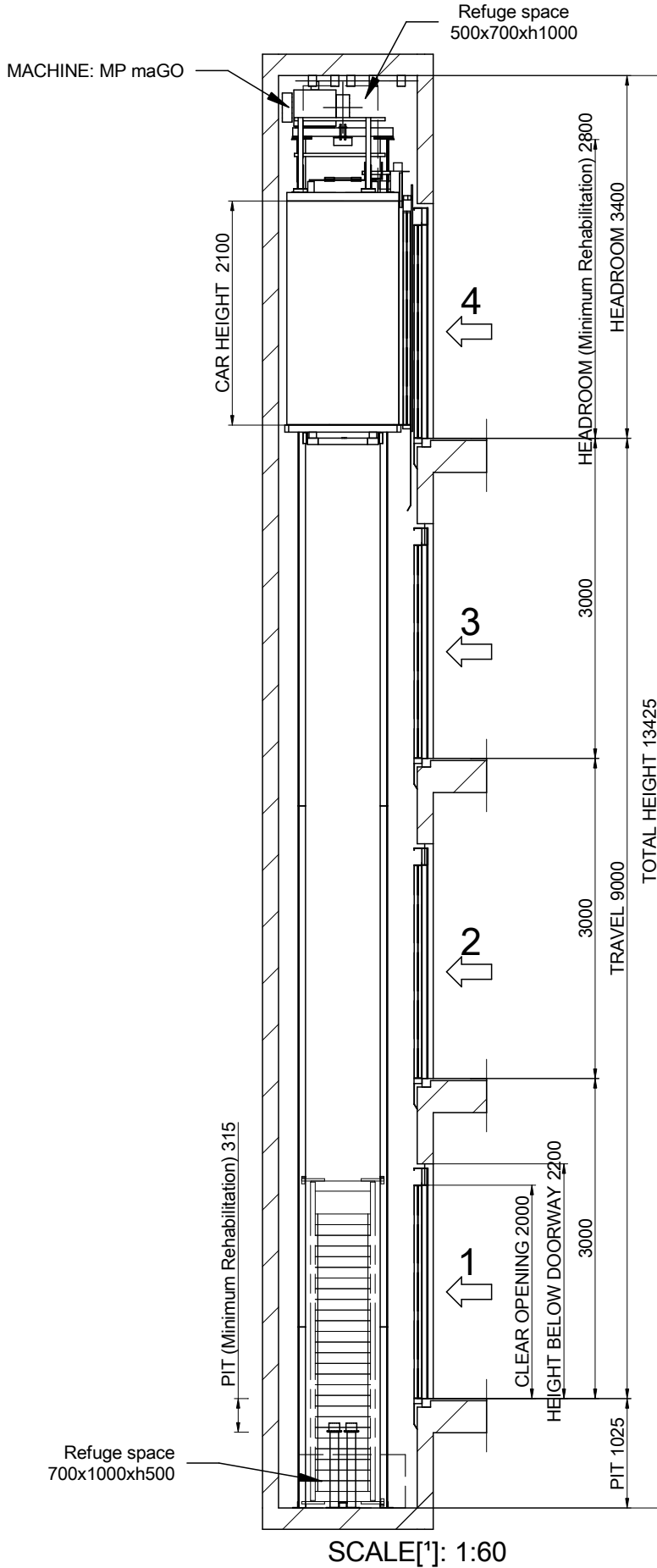

DRAWING	DATE	REV.	SHEET	[*] Unbounded dimensions in drawings are indicative and not binding.	
MP	2016	00	2/8		
MODEL LIFT:				REFERENCE:	
MP GO! FLEX				MPGO!FLEXLATERAL375S_EN	
CAPACITY: [N° PERSONS]				5	CLIENT:
NOMINAL LOAD: [kg]				375	WORK SITUATION:
SPEED: [m/s]				1	
FREQUENCY: [Hz]				50	
TENSION: [V]				380V [Three-phase]	MP LIFTS

02-SIDE VERTICAL SECTION



DRAWING		DATE	REV.	SHEET	[!] Unbounded dimensions in drawings are indicative and not binding. REFERENCE: MPGOIFLEXLATERAL375S_EN	
MP	2016	00	3/8			
MODEL LIFT:		MP GO! FLEX			CLIENT:	WORK SITUATION:
CAPACITY: [N° PERSONS]		5				
NOMINAL LOAD: [kg]		375				
SPEED: [m/s]		1				
FREQUENCY: [Hz]		50				
TENSION: [V]		380V [Three-phase]				MP LIFTS

Flat and levelled floor, protected against water leaking.
 [EN81-20:2014 5.2.1.9]
 Foresee pit access device
 [EN81-20:2014 5.2.2.4]
 Stop device
 [EN81-20:2014 5.2.1.5.1. a)
 Inspection control station.
 [EN81-20:2014 5.2.1.5.1. b)
 Power supply
 [EN81-20:2014 5.2.1.5.1. c)
 Light switch
 commuted with the cabinet.
 [EN81-20:2014 5.2.1.5.1. d)

03B-FIXING DETAILS IN HEADROOM

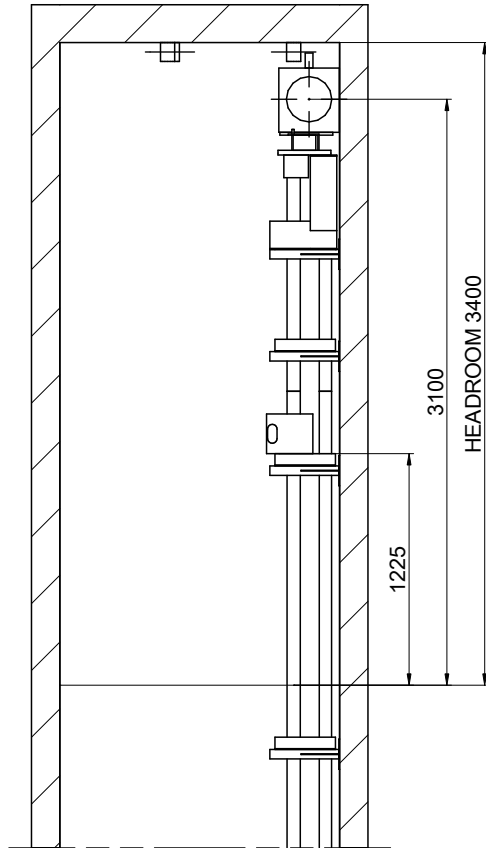

SCALE[*]: 1:40

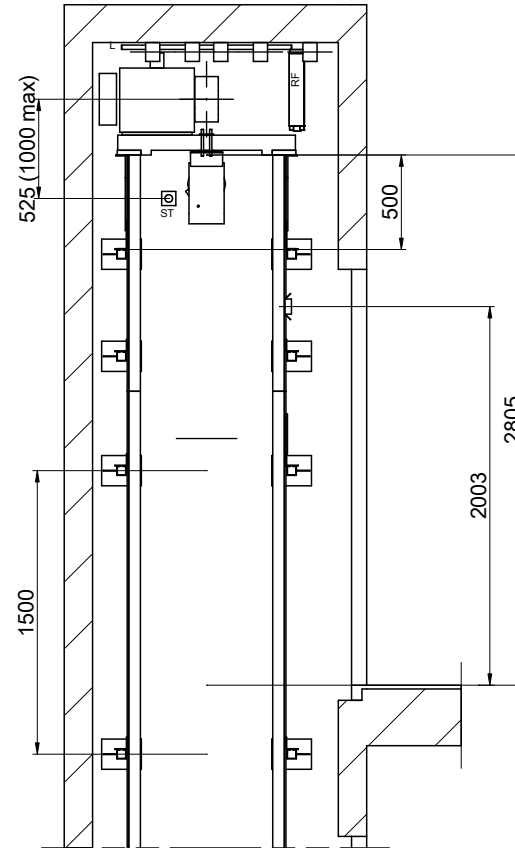

SCALE[*]: 1:40

DRAWING	DATE	REV.	SHEET
MP	2016	00	4/8
MODEL LIFT:			
MP GO! FLEX			
CAPACITY: [N° PERSONS]			5
NOMINAL LOAD: [kg]			375
SPEED: [m/s]			1
FREQUENCY: [Hz]			50
TENSION: [V]		380V [Three-phase]	

[*] Unbounded dimensions in drawings are indicative and not binding.

REFERENCE:
MPGO!FLEXLATERAL375S_EN

CLIENT:
WORK SITUATION:



MP LIFTS

04-BEAM AND LIFTING HOOKS

POSITION OF REMOVABLE LIFTING HOOKS ABLE TO SUPPORT
1000 kg EACH ONE SUPPLIED BY CONSTRUCTOR
(RECOMMENDED POSITION LOADHOOKS)

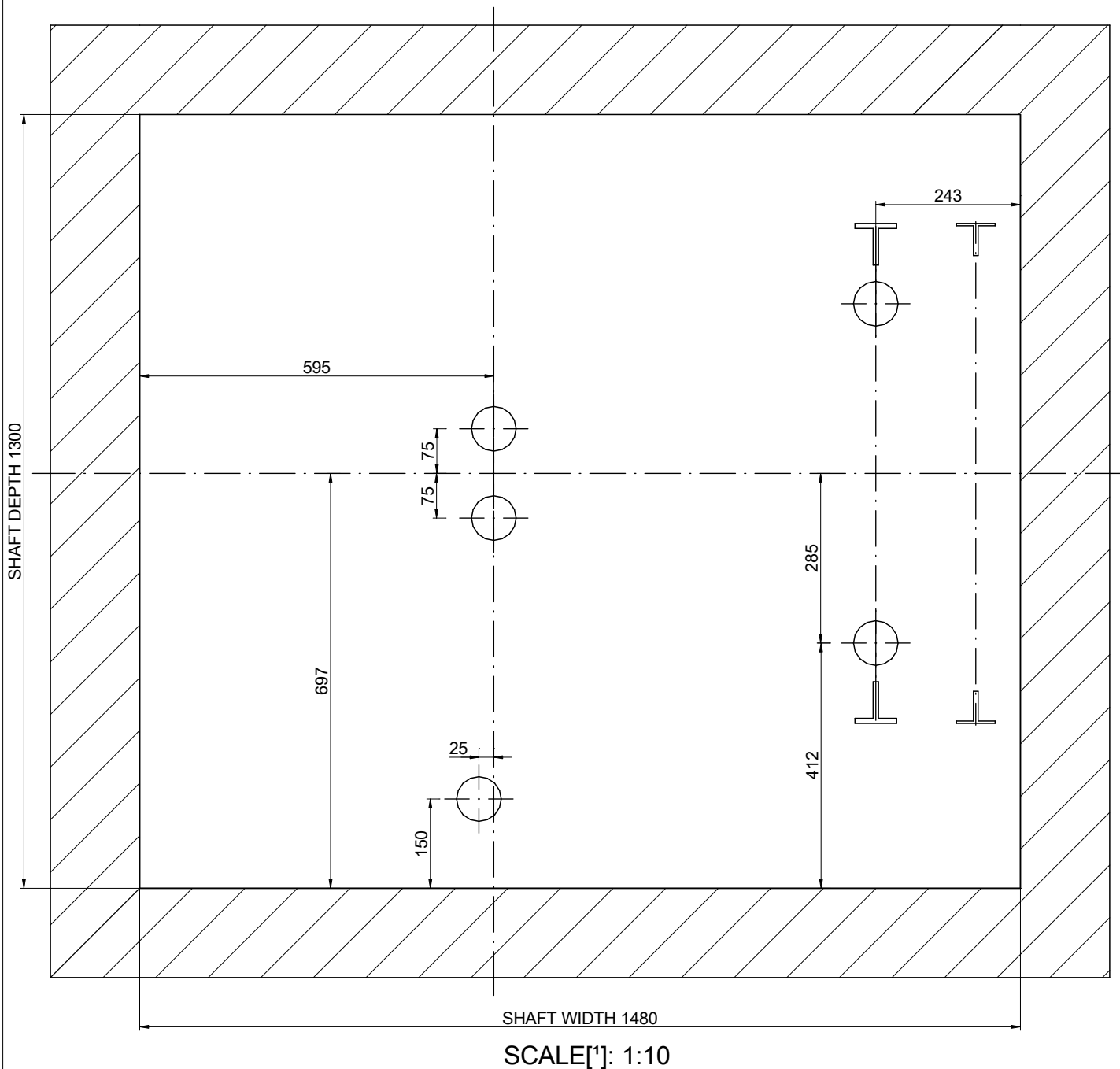

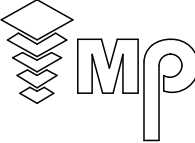
DRAWING	DATE	REV.	SHEET	[*] Unbounded dimensions in drawings are indicative and not binding.	
MP	2016	00	5/8	REFERENCE: MPGO!FLEXLATERAL375S_EN	
MODEL LIFT:				CLIENT:	<p>MP LIFTS</p>
MP GO! FLEX				WORK SITUATION:	
CAPACITY: [N° PERSONS]			5		
NOMINAL LOAD: [kg]			375		
SPEED: [m/s]			1		
FREQUENCY: [Hz]			50		
TENSION: [V]		380V [Three-phase]			

05-PIT LAYOUT

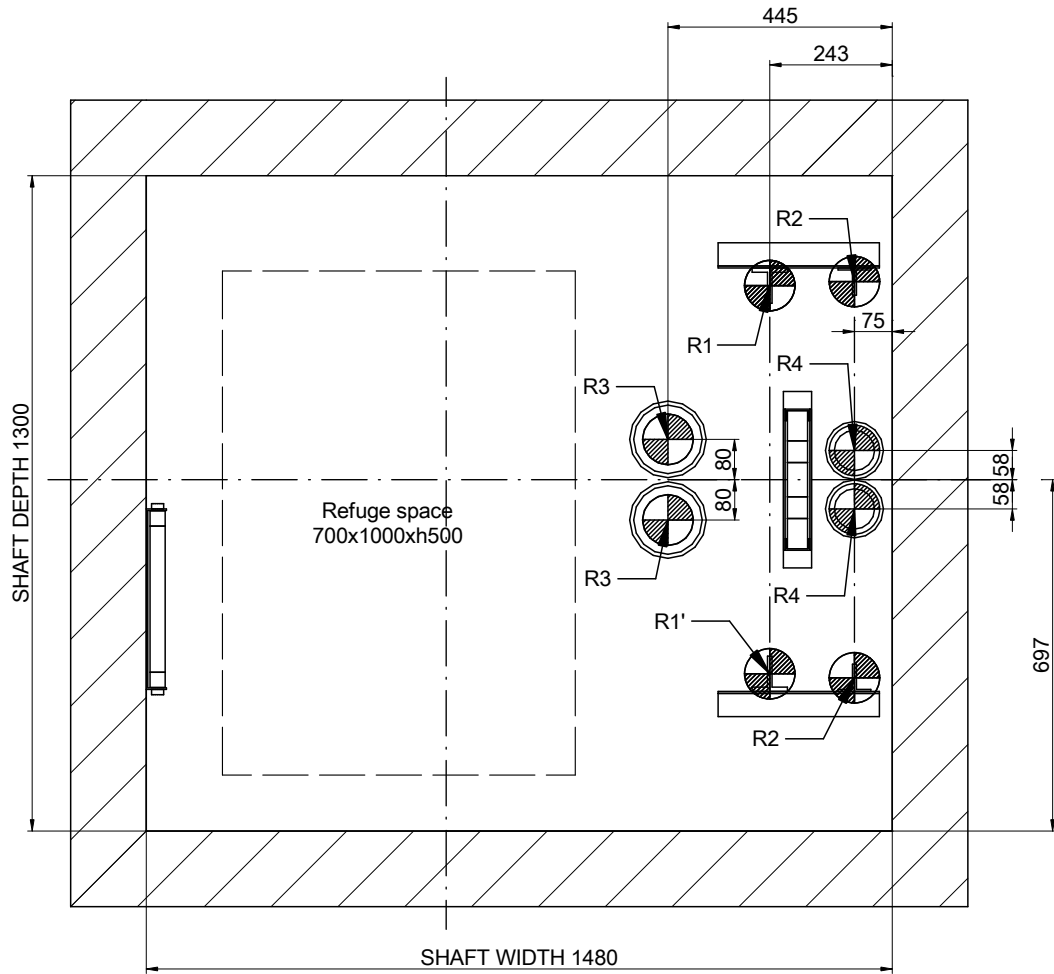

REACTIONS [N] [max.]			
R1	20000	R2	1000
R1'	20000	R2'	1000
R3	20500	R4	17500
N	3000	T	1000

DRAWING	DATE	REV.	SHEET	[*] Unbounded dimensions in drawings are indicative and not binding. REFERENCE: MPGOIFLEXLATERAL375S_EN	
MP	2016	00	6/8		
MODEL LIFT:				CLIENT:	WORK SITUATION:
MP GO! FLEX					
CAPACITY: [N° PERSONS]			5	<h2>MP LIFTS</h2>	
NOMINAL LOAD: [kg]			375		
SPEED: [m/s]			1		
FREQUENCY: [Hz]			50		
TENSION: [V]			380V [Three-phase]		

06-DOOR HOLE DETAIL

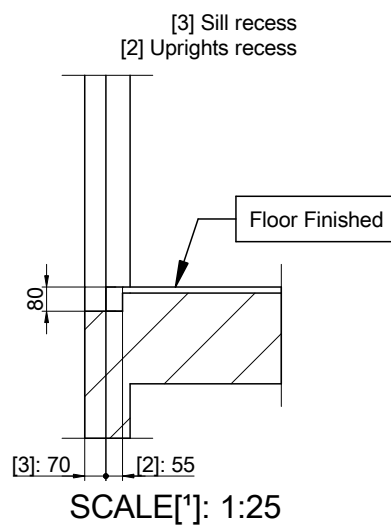
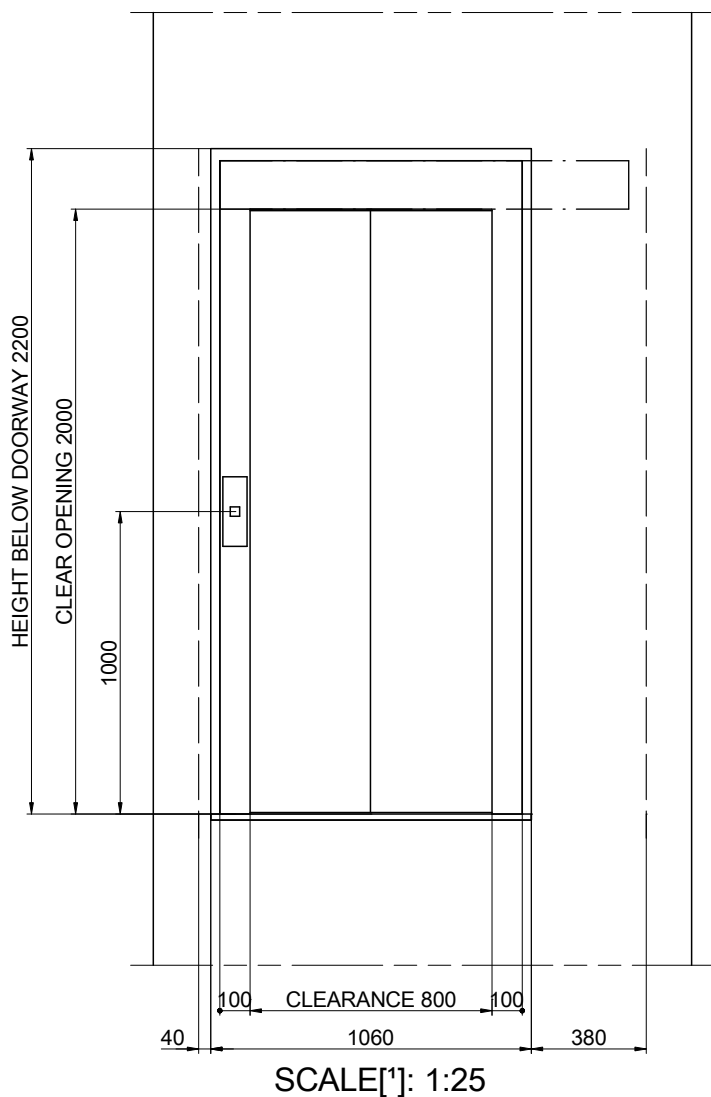

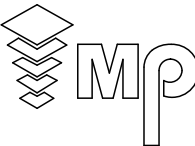
DRAWING	DATE	REV.	SHEET	[*] Unbounded dimensions in drawings are indicative and not binding.	
MP	2016	00	7/8	REFERENCE: MPGO!FLEXLATERAL375S_EN	
MODEL LIFT:				CLIENT:	WORK SITUATION:
MP GO! FLEX					
CAPACITY: [N° PERSONS]			5	<p style="text-align: center; font-size: 2em; font-weight: bold;">MP LIFTS</p>	
NOMINAL LOAD: [kg]			375		
SPEED: [m/s]			1		
FREQUENCY: [Hz]			50		
TENSION: [V]			380V [Three-phase]		

07-HEADROOM

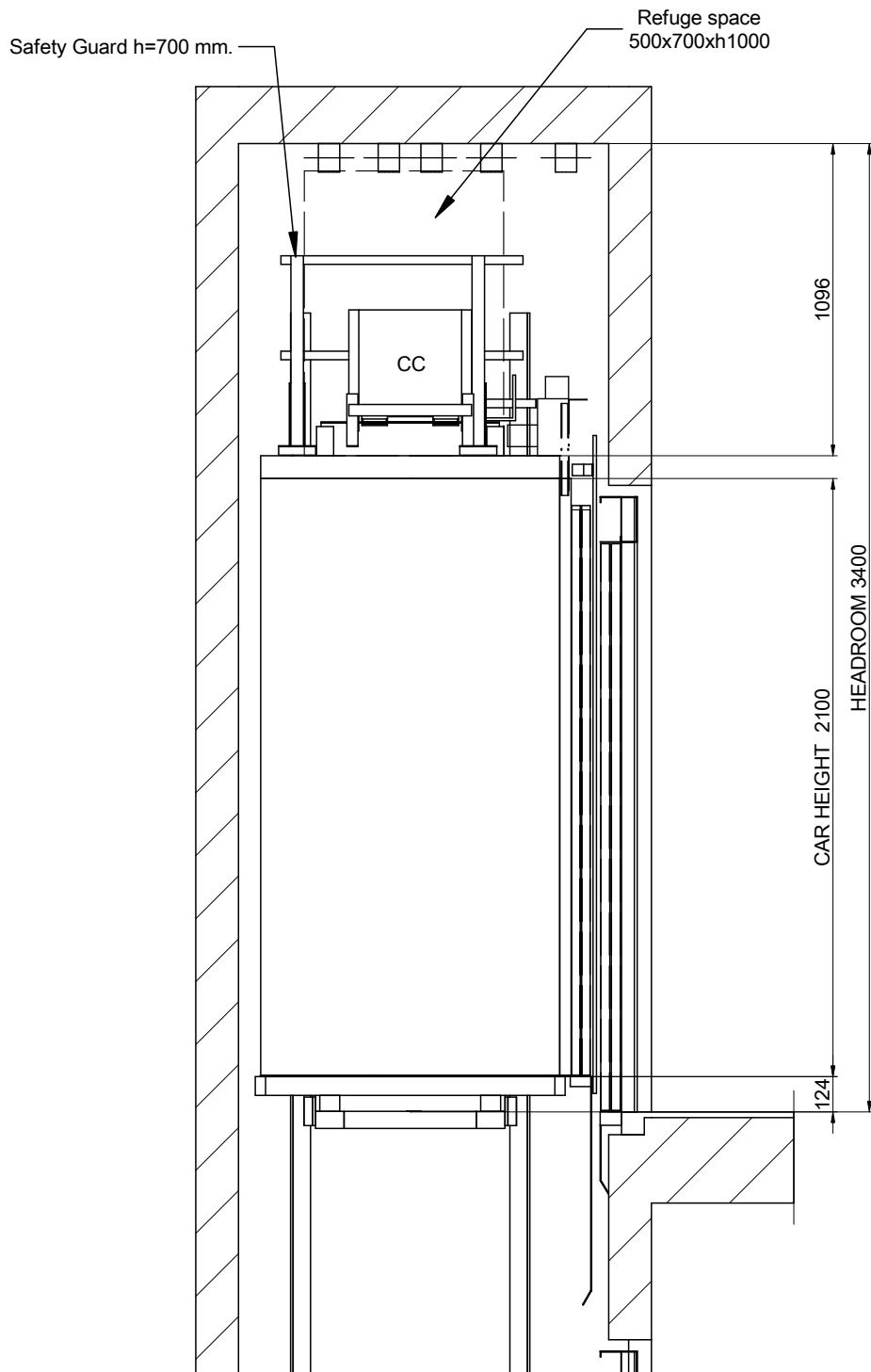

SCALE[*]: 1:25

DRAWING	DATE	REV.	SHEET	[*] Unbounded dimensions in drawings are indicative and not binding. REFERENCE: MPGO!FLEXLATERAL375S_EN	
MP	2016	00	8/8		
MODEL LIFT:				CLIENT:	WORK SITUATION:
MP GO! FLEX					
CAPACITY: [N° PERSONS]			5	<h2>MP LIFTS</h2>	
NOMINAL LOAD: [kg]			375		
SPEED: [m/s]			1		
FREQUENCY: [Hz]			50		
TENSION: [V]			380V [Three-phase]		