

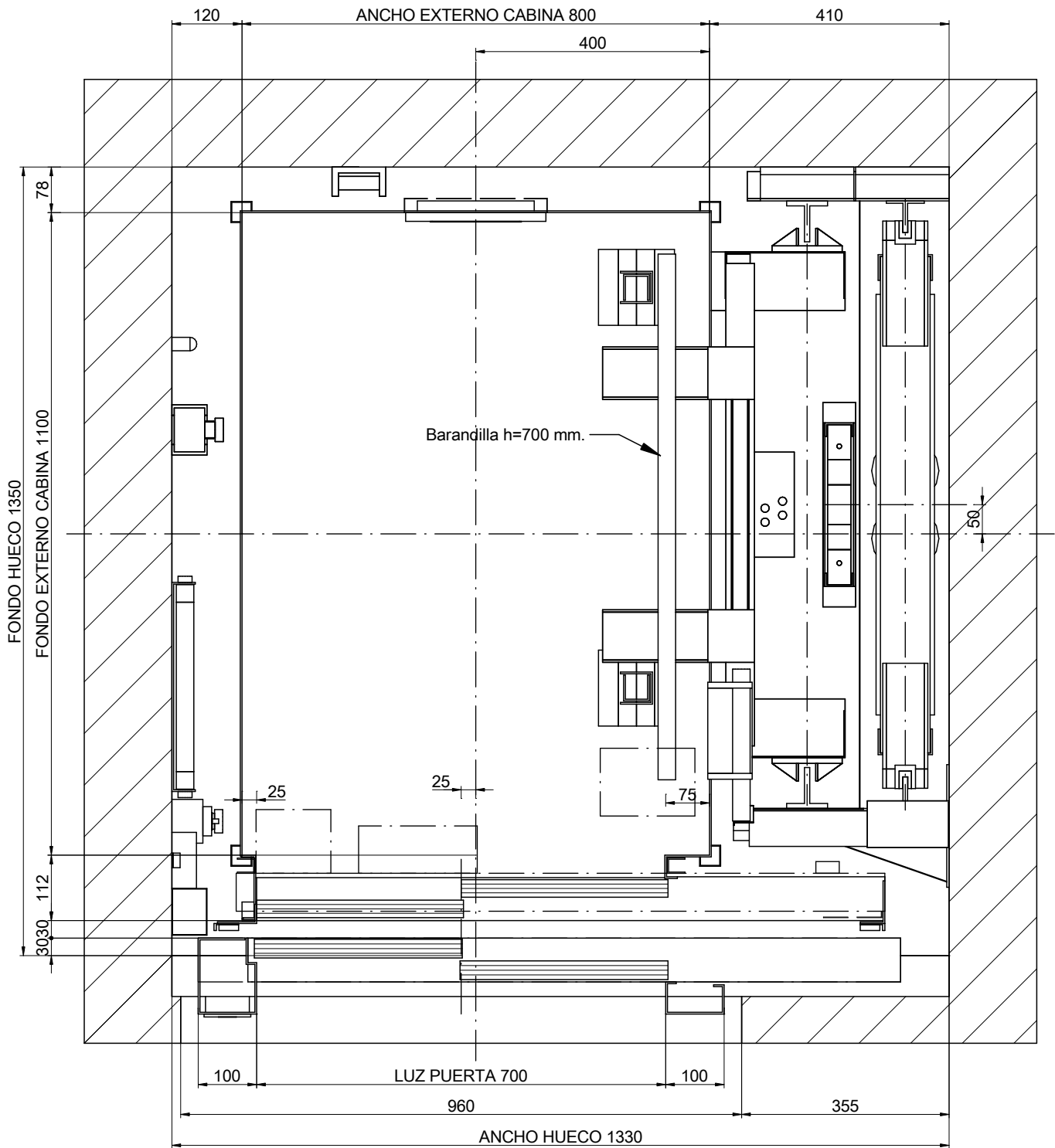

01-PLANTA



ESCALA[*]: 1:10

DIBUJADO	FECHA	REV.	HOJA	[*] Las dimensiones no acotadas en el plano son indicativas y no vinculantes.	
MP	2016	00	1/8		
MODELO ASCENSOR:				REFERENCIA:	
MP GO! FLEX				MPGO!FLEXLATERAL320S_ES	
CAPACIDAD: [Nº PERSONAS]				4	CLIENTE:
CARGA UTIL: [kg]				320	SITUACION OBRA:
VELOCIDAD: [m/s]				1	
FRECUENCIA: [Hz]				50	
TENSION: [V]				380V [Trifásica]	
MP ASCENSORES					

01B-PLANTA

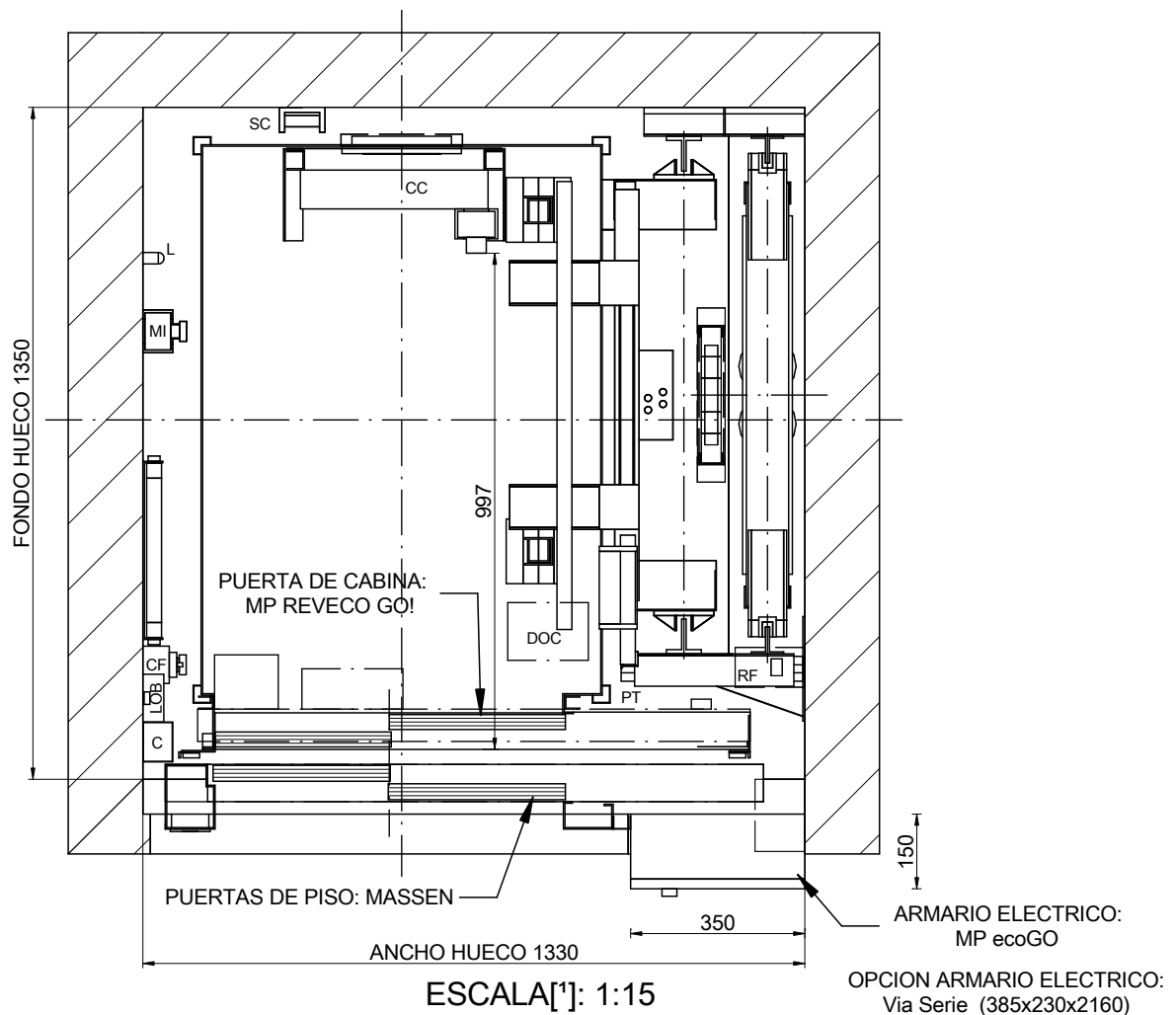

NOMENCLATURA

- C: Canaleta
- CC: Caja conexiones techo cabina
- CF: Caja foso
- CL: Conmutador Luz Hueco
- DOC: Caja Control Operador
- L: Luminaria
- LOB: Placa Control Botoneras
- MI: Mando Inspección
- PT: Patín
- RF: Resistencia Frenado
- ST: Dispositivo parada
- SC: Soporte cuerda maniobra

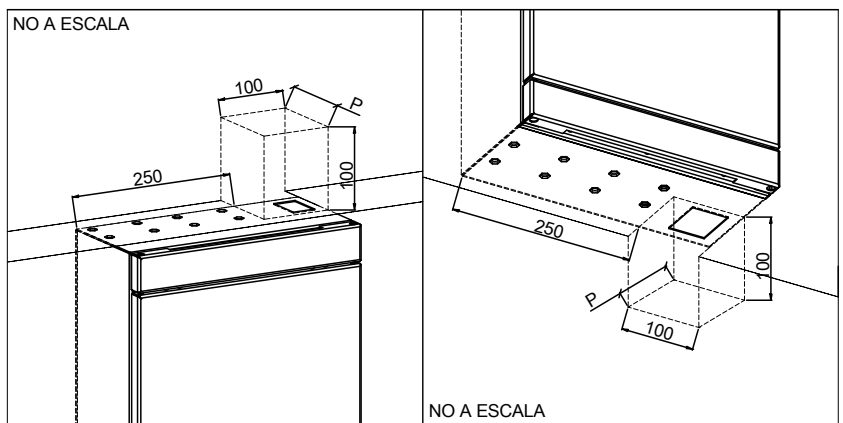

DIBUJADO	FECHA	REV.	HOJA
MP	2016	00	2/8
MODELO ASCENSOR:			
MP GO! FLEX			
CAPACIDAD: [Nº PERSONAS]		4	
CARGA UTIL: [kg]		320	
VELOCIDAD: [m/s]		1	
FRECUENCIA: [Hz]		50	
TENSION: [V]		380V [Trifásica]	

[*] Las dimensiones no acotadas en el plano son indicativas y no vinculantes.

REFERENCIA:
MPGO!FLEXLATERAL320S_ES

CLIENTE:
SITUACION OBRA:



MP ASCENSORES

02-ALZADO LATERAL

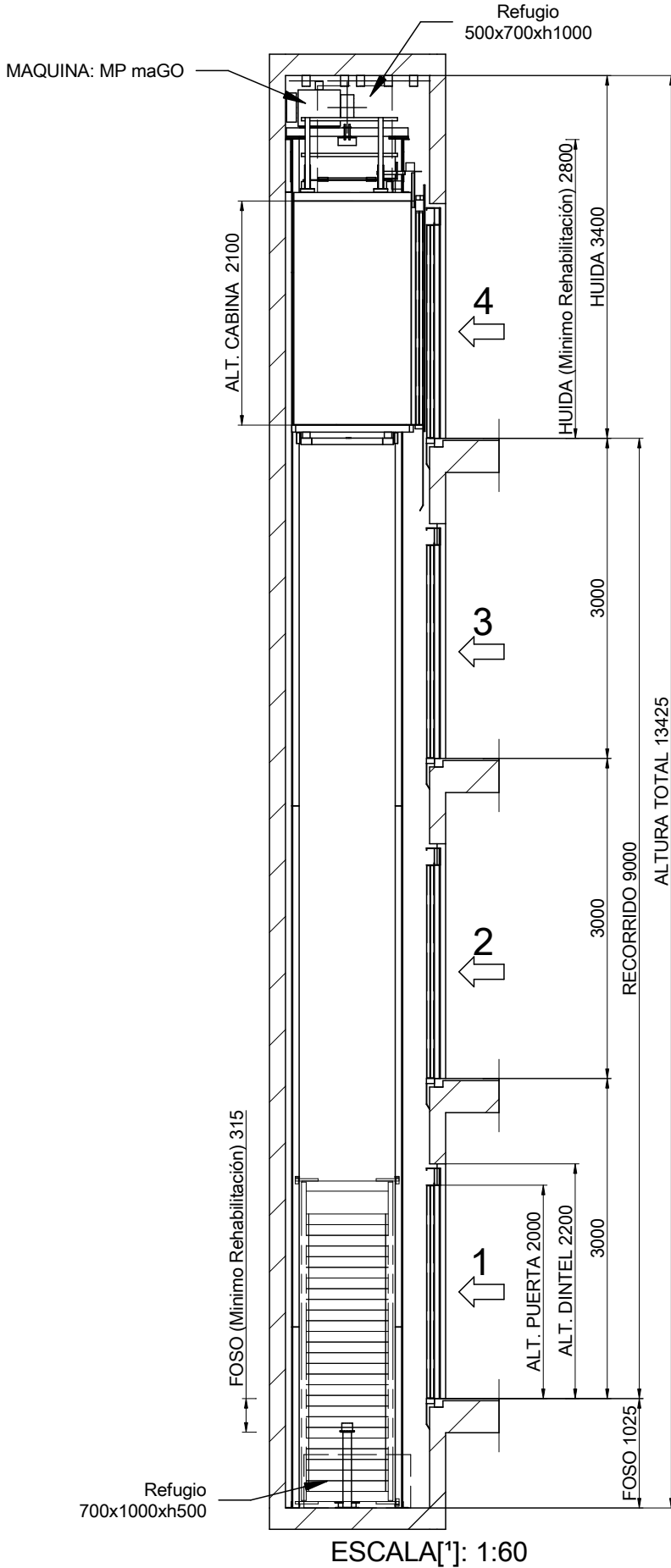

		[*] Las dimensiones no acotadas en el plano son indicativas y no vinculantes.	
		DIBUJADO	HOJA
MP	2016	REV. 00	3/8
MODELO ASCENSOR:		MP GO! FLEX	
REFERENCIA:		MPGOIFLEXLATERAL320S_ES	
CAPACIDAD: [N° PERSONAS]		4	
CARGA UTIL: [kg]		320	
VELOCIDAD: [m/s]		1	
FRECUENCIA: [Hz]		50	
TENSION: [V]		380V [Trifásica]	
CLIENTE:		SITUACION OBRA:	
		MP ASCENSORES	

Foso liso y a nivel protegido de infiltraciones de agua.
 [EN81-20:2014 5.2.1.9]
 Prever dispositivo de acceso.
 [EN81-20:2014 5.2.2.4]
 Dispositivo de parada.
 [EN81-20:2014 5.2.1.5.1. a]
 Estación de control de inspección.
 [EN81-20:2014 5.2.1.5.1 b]
 Toma de corriente.
 [EN81-20:2014 5.2.1.5.1. c]
 Interruptor de alumbrado, conmutado con el armario.
 [EN81-20:2014 5.2.1.5.1. d]

03B-DETALLES DE FIJACION EN LA HUIDA

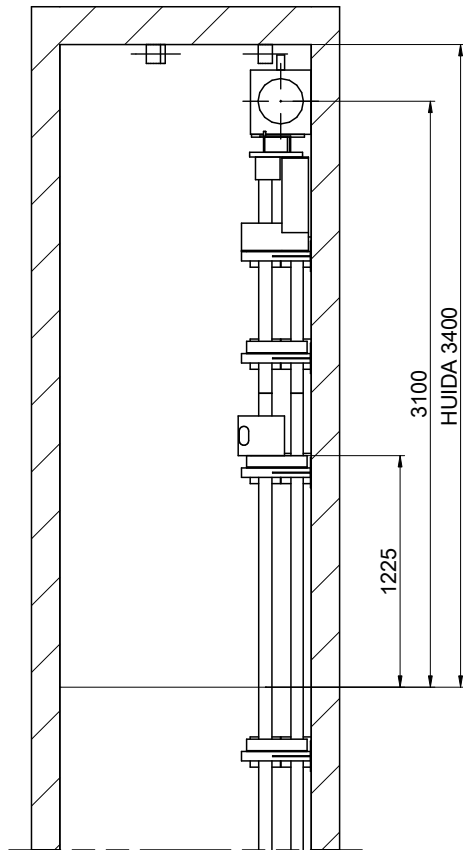

ESCALA[*]: 1:40

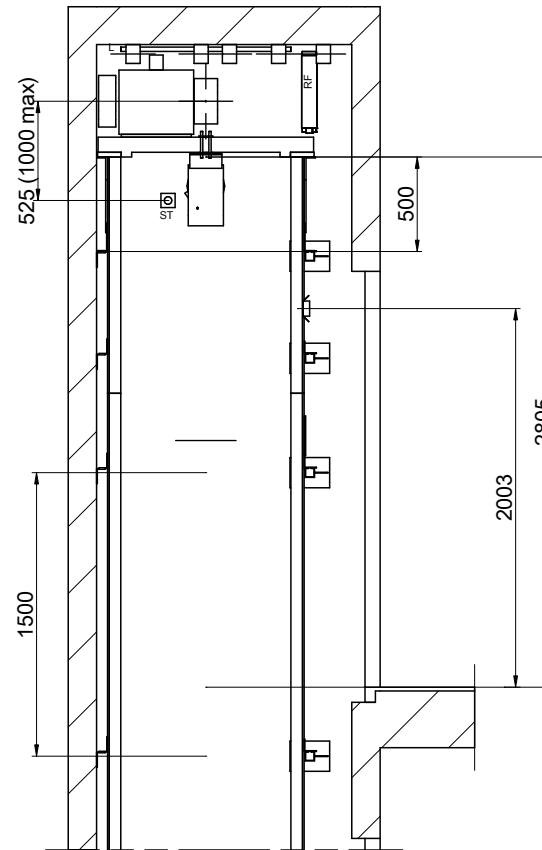

ESCALA[*]: 1:40

DIBUJADO	FECHA	REV.	HOJA
MP	2016	00	4/8
MODELO ASCENSOR:			
MP GO! FLEX			
CAPACIDAD: [Nº PERSONAS]			4
CARGA UTIL: [kg]			320
VELOCIDAD: [m/s]			1
FRECUENCIA: [Hz]			50
TENSION: [V]		380V [Trifásica]	

[*] Las dimensiones no acotadas en el plano son indicativas y no vinculantes.

REFERENCIA:
MPGO!FLEXLATERAL320S_ES

CLIENTE:
SITUACION OBRA:

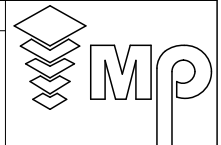

MP ASCENSORES

04-VIGA Y GANCHOS DE MONTAJE

POSICION DE LOS GANCHOS DESMONTABLES CAPACES DE SOPORTAR
1000 kg CADA UNO A SUMINISTRAR POR EL CONSTRUCTOR
(POSICION RECOMENDADA GANCHOS DE MONTAJE)

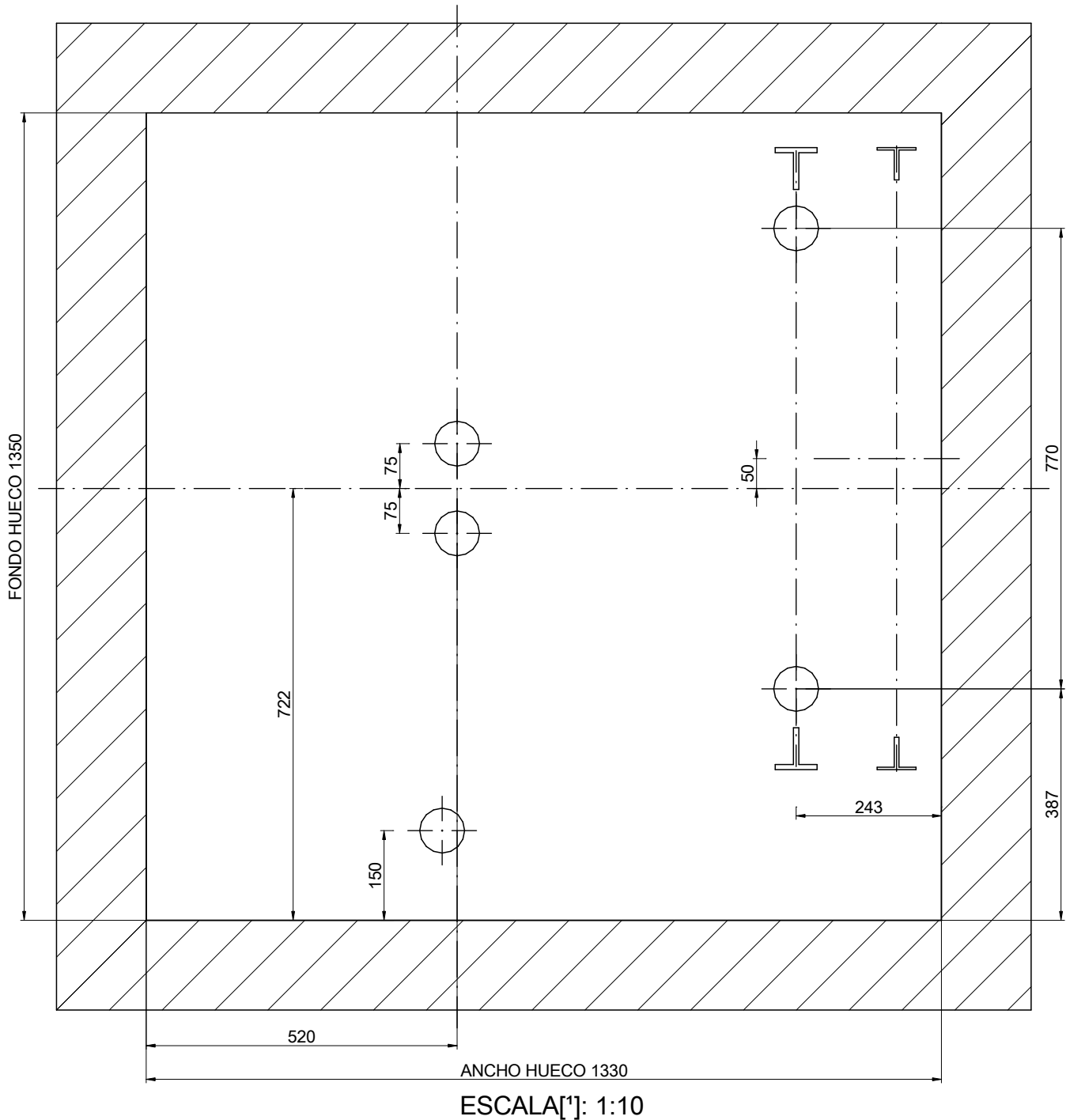

DIBUJADO	FECHA	REV.	HOJA	[*] Las dimensiones no acotadas en el plano son indicativas y no vinculantes.	
MP	2016	00	5/8	REFERENCIA: MPGO!FLEXLATERAL320S_ES	
MODELO ASCENSOR:				CLIENTE:	SITUACION OBRA:
MP GO! FLEX					
CAPACIDAD: [N° PERSONAS]			4	<p style="text-align: center;">MP ASCENSORES</p>	
CARGA UTIL: [kg]			320		
VELOCIDAD: [m/s]			1		
FRECUENCIA: [Hz]			50		
TENSION: [V]			380V [Trifásica]		

05-PLANTA DE FOSO

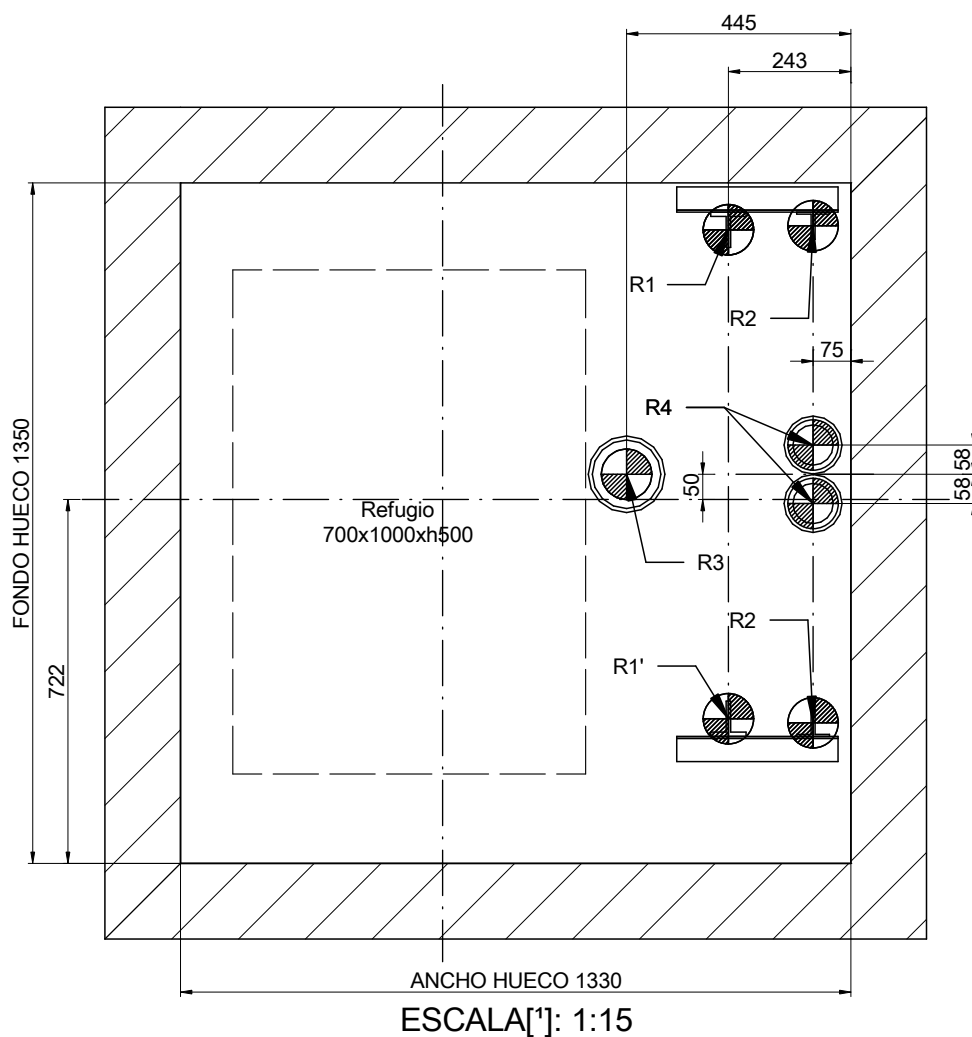



REACCIONES [N] [max.]			
R1	17000	R2	900
R1'	17000	R2'	900
R3	39000	R4	16500
N	1800	T	600

DIBUJADO	FECHA	REV.	HOJA	[*] Las dimensiones no acotadas en el plano son indicativas y no vinculantes.	
MP	2016	00	6/8		
MODELO ASCENSOR:				REFERENCIA:	
MP GO! FLEX				MPGO!FLEXLATERAL320S_ES	
CAPACIDAD: [Nº PERSONAS]				CLIENTE:	MP ASCENSORES
CARGA UTIL: [kg]				SITUACION OBRA:	
VELOCIDAD: [m/s]					
FRECUENCIA: [Hz]					
TENSION: [V]					
380V [Trifásica]					

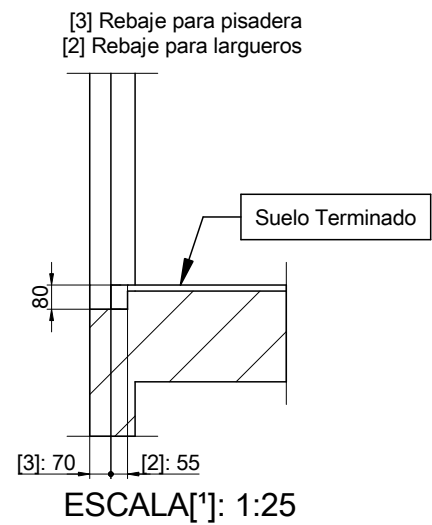
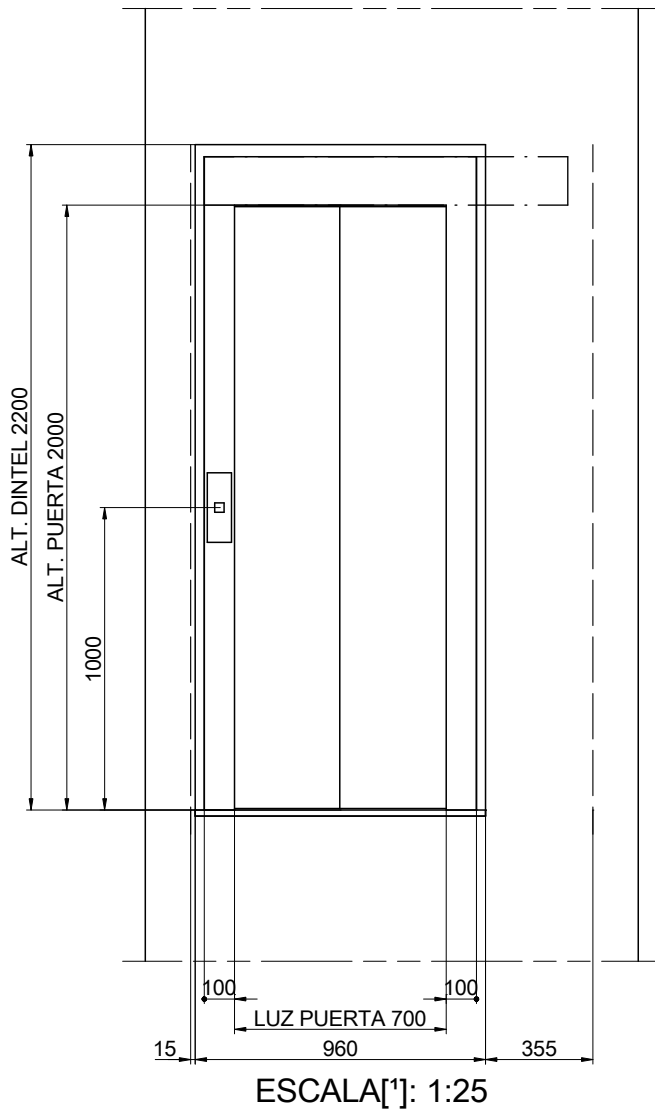
06-DETALLE DE HUECO DE PUERTA



DIBUJADO	FECHA	REV.	HOJA	[*] Las dimensiones no acotadas en el plano son indicativas y no vinculantes.	
MP	2016	00	7/8	REFERENCIA: MPGO!FLEXLATERAL320S_ES	
MODELO ASCENSOR:				CLIENTE:	
MP GO! FLEX				SITUACION OBRA:	
CAPACIDAD: [Nº PERSONAS]		4			
CARGA UTIL: [kg]		320			
VELOCIDAD: [m/s]		1			
FRECUENCIA: [Hz]		50			
TENSION: [V]		380V [Trifásica]			
				MP ASCENSORES	

07-HUIDA

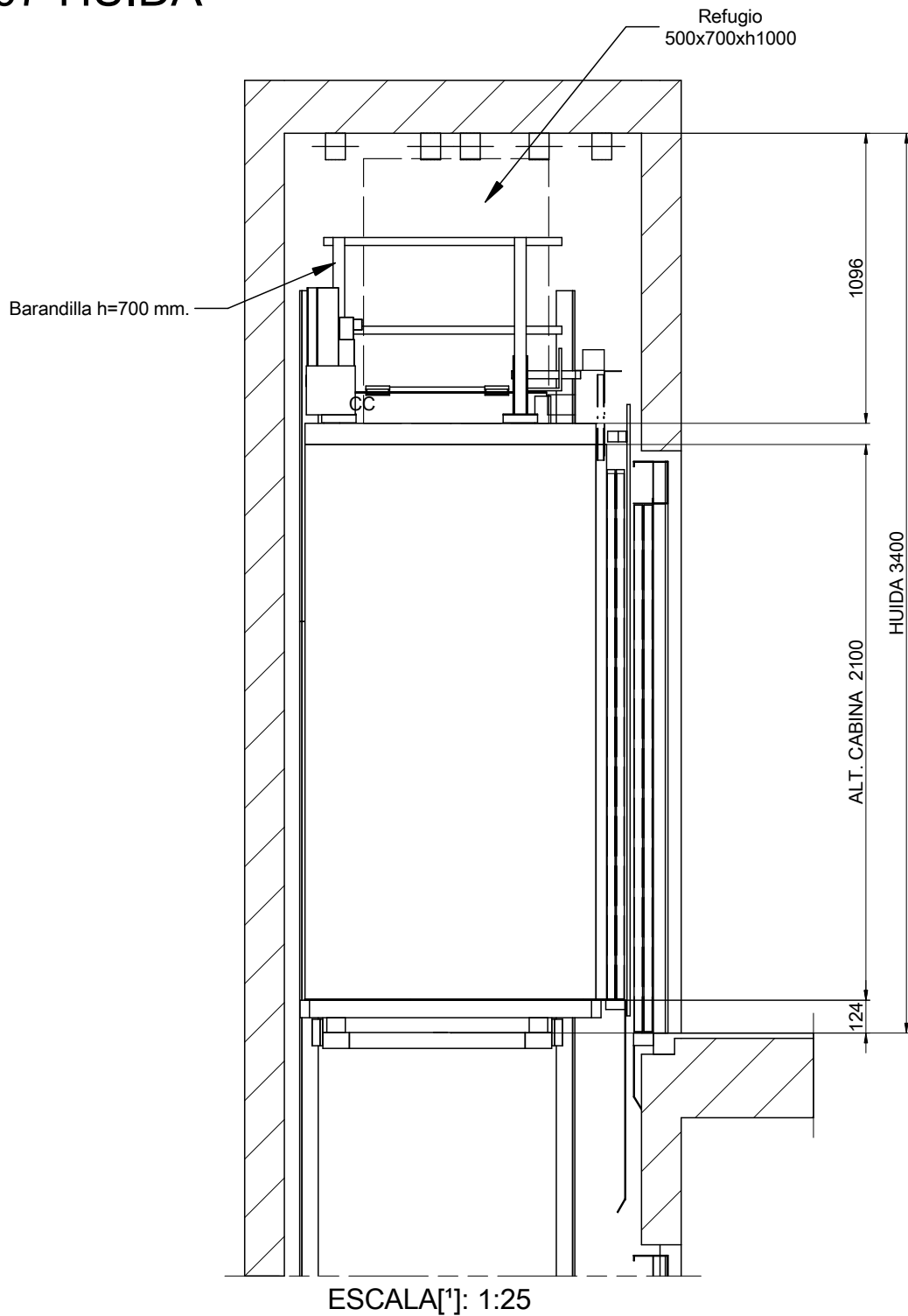

DIBUJADO	FECHA	REV.	HOJA	[*] Las dimensiones no acotadas en el plano son indicativas y no vinculantes.		
MP	2016	00	8/8	REFERENCIA: MPGO!FLEXLATERAL320S_ES		
MODELO ASCENSOR:				CLIENTE:		MP ASCENSORES
MP GO! FLEX				SITUACION OBRA:		
CAPACIDAD: [Nº PERSONAS]			4			
CARGA UTIL: [kg]			320			
VELOCIDAD: [m/s]			1			
FRECUENCIA: [Hz]			50			
TENSION: [V]		380V [Trifásica]				