

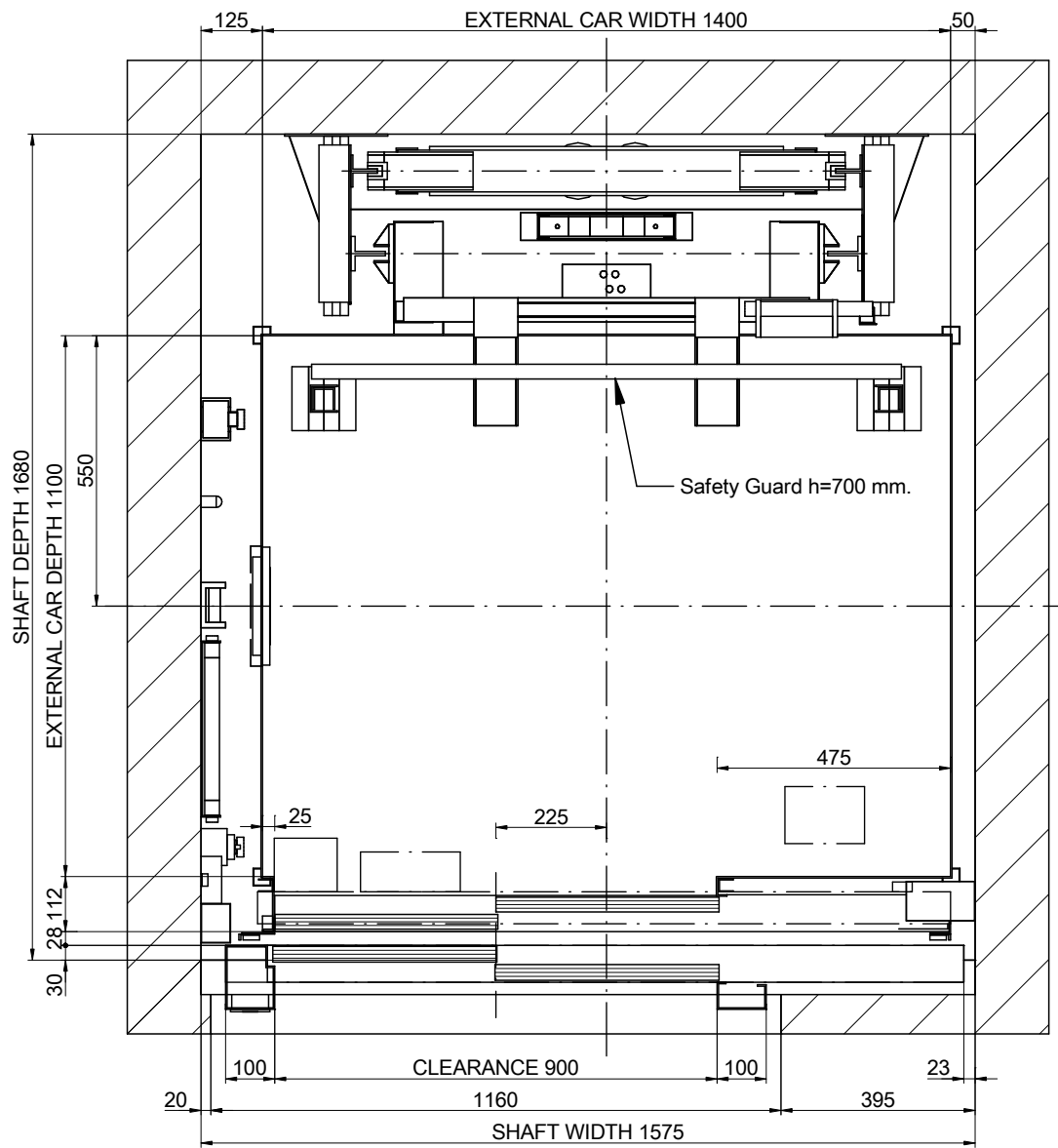

# 01-PLAN VIEW



SCALE[\*]: 1:15

DRAWING	DATE	REV.	SHEET	[*] Unbounded dimensions in drawings are indicative and not binding.	
MP	2016	00	1/8		
MODEL LIFT:				REFERENCE:	
<b>MP GO! FLEX</b>				MPGO!FLEXFONDO630S_EN	
CAPACITY: [N° PERSONS]				8	CLIENT:
NOMINAL LOAD: [kg]				630	WORK SITUATION:
SPEED: [m/s]				1	
FREQUENCY: [Hz]				50	
TENSION: [V]				380V [Three-phase]	<b>MP LIFTS</b>

# 01B-PLAN VIEW

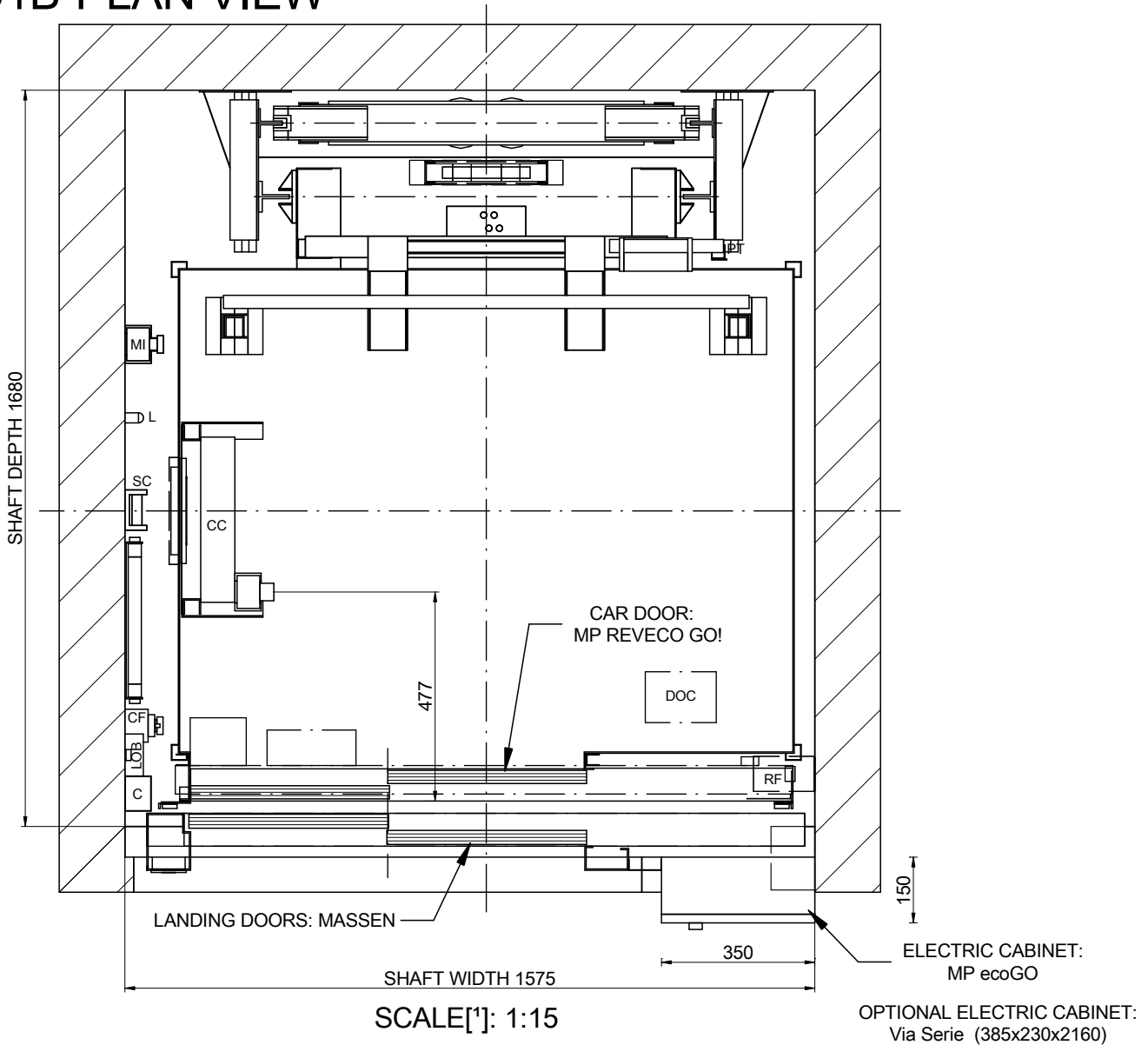

## NOMENCLATURE

- C: Wiring channel
- CC: Car ceiling connection box
- CF: Pit box
- CL: Shaft light switch
- DOC: Operator control box
- L: Lamp
- LOB: Pushbutton control board
- MI: Inspection control station
- PT: Fixed cam
- RF: Brake resistor
- ST: Stopping device
- SC: Travelling cable support

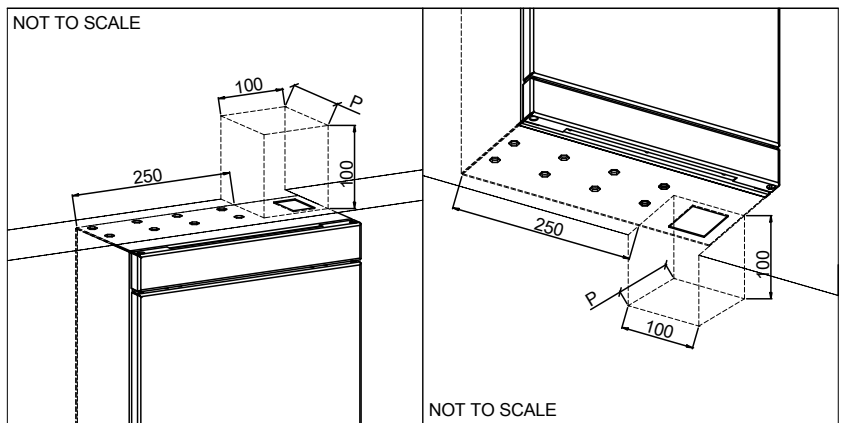

DRAWING	DATE	REV.	SHEET
MP	2016	00	2/8
MODEL LIFT:			
<b>MP GO! FLEX</b>			
CAPACITY: [N° PERSONS]		8	
NOMINAL LOAD: [kg]		630	
SPEED: [m/s]		1	
FREQUENCY: [Hz]		50	
TENSION: [V]		380V [Three-phase]	

[\*] Unbounded dimensions in drawings are indicative and not binding.

REFERENCE:  
MPGO!FLEXFONDO630S\_EN

CLIENT:  
WORK SITUATION:

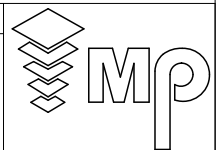

## MP LIFTS

# 02-SIDE VERTICAL SECTION

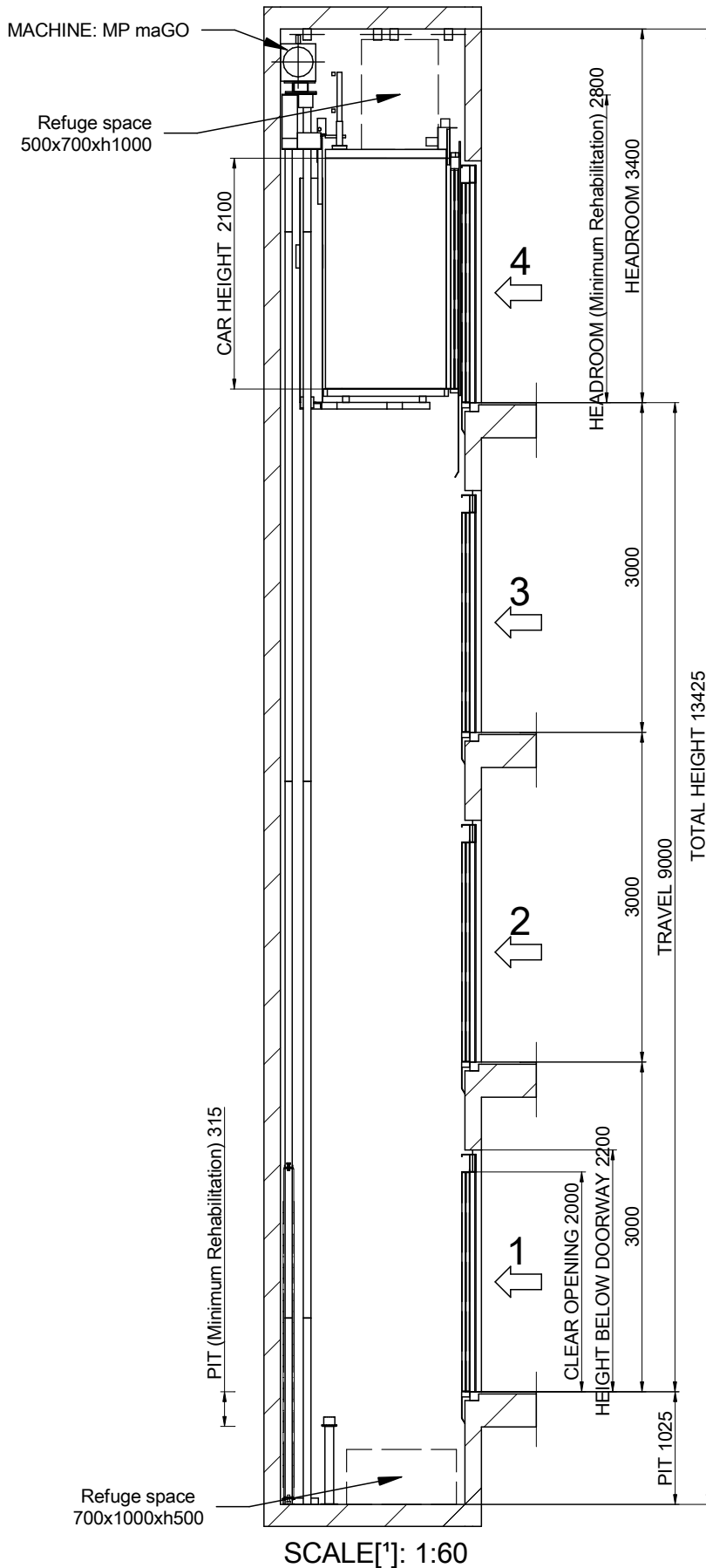

DRAWING		DATE	REV.	SHEET	[*] Unbounded dimensions in drawings are indicative and not binding.
MP	2016	00	3/8	REFERENCE: MPGOIFLEXFONDO630S_EN	
MODEL LIFT:		MP GO! FLEX			CLIENT: WORK SITUATION:
CAPACITY: [N° PERSONS]		8			
NOMINAL LOAD: [kg]		630			
SPEED: [m/s]		1			
FREQUENCY: [Hz]		50			
TENSION: [V]		380V [Three-phase]			

Flat and levelled floor, protected against water leaking.  
 [EN81-20:2014 5.2.1.9]  
 Foresee pit access device  
 [EN81-20:2014 5.2.2.4]  
 Stop device  
 [EN81-20:2014 5.2.1.5.1. a]  
 Inspection control station.  
 [EN81-20:2014 5.2.1.5.1. b]  
 Power supply  
 [EN81-20:2014 5.2.1.5.1. c]  
 Light switch  
 commuted with the cabinet.  
 [EN81-20:2014 5.2.1.5.1. d]



MP LIFTS

# 03B-FIXING DETAILS IN HEADROOM

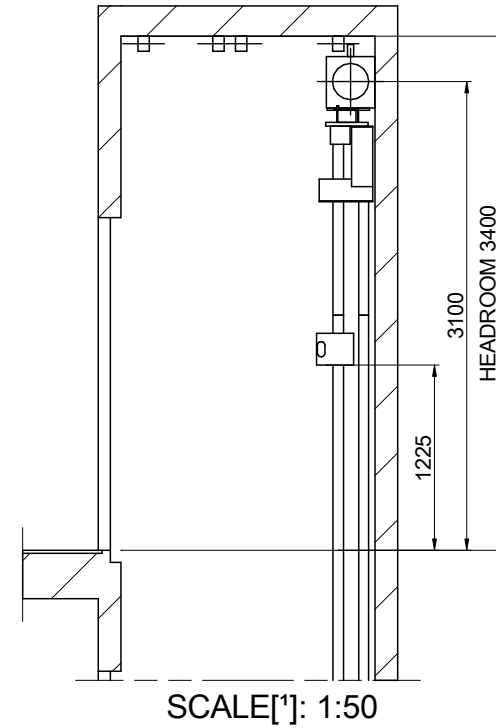
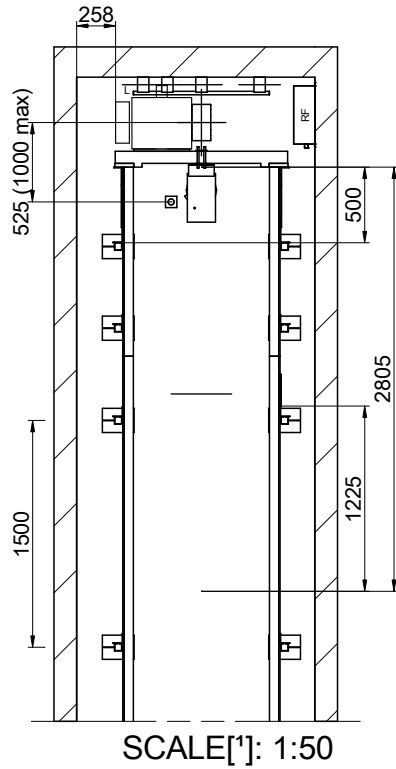

DRAWING	DATE	REV.	SHEET
MP	2016	00	4/8
MODEL LIFT:			
<b>MP GO! FLEX</b>			
CAPACITY: [N° PERSONS]			8
NOMINAL LOAD: [kg]			630
SPEED: [m/s]			1
FREQUENCY: [Hz]			50
TENSION: [V]		380V [Three-phase]	

[\*] Unbounded dimensions in drawings are indicative and not binding.

REFERENCE:  
MPGO!FLEXFONDO630S\_EN

CLIENT:  
WORK SITUATION:

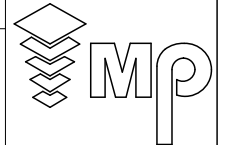

**MP LIFTS**

# 04-BEAM AND LIFTING HOOKS

POSITION OF REMOVABLE LIFTING HOOKS ABLE TO SUPPORT  
1000 kg EACH ONE SUPPLIED BY CONSTRUCTOR  
(RECOMMENDED POSITION LOADHOOKS)

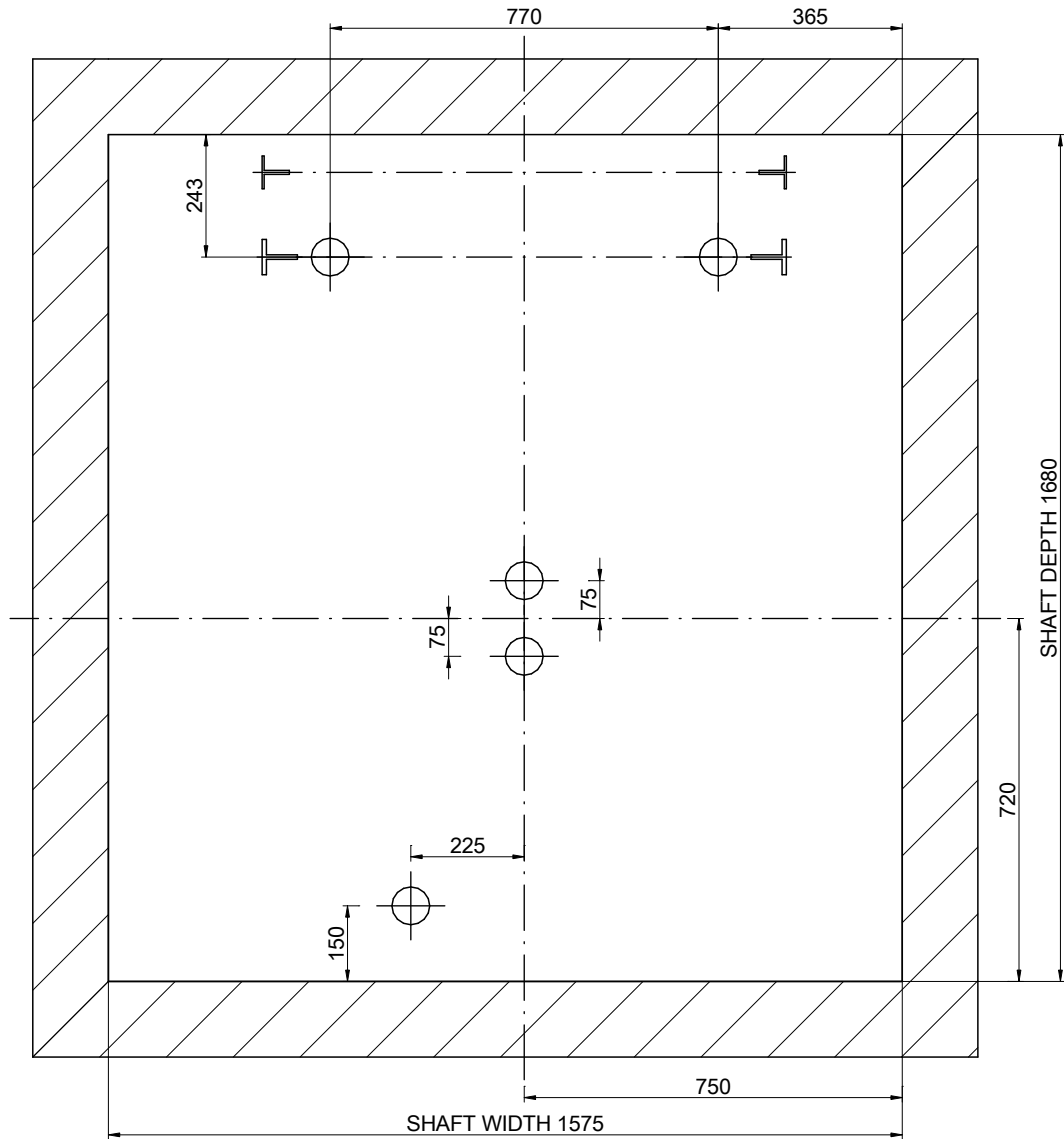

SCALE[\*]: 1:15

DRAWING	DATE	REV.	SHEET	[*] Unbounded dimensions in drawings are indicative and not binding.	
MP	2016	00	5/8	REFERENCE: MPGO!FLEXFONDO630S_EN	
MODEL LIFT:				CLIENT:	WORK SITUATION:
MP GO! FLEX					
CAPACITY: [N° PERSONS]			8	<h2>MP LIFTS</h2>	
NOMINAL LOAD: [kg]			630		
SPEED: [m/s]			1		
FREQUENCY: [Hz]			50		
TENSION: [V]			380V [Three-phase]		

# 05-PIT LAYOUT

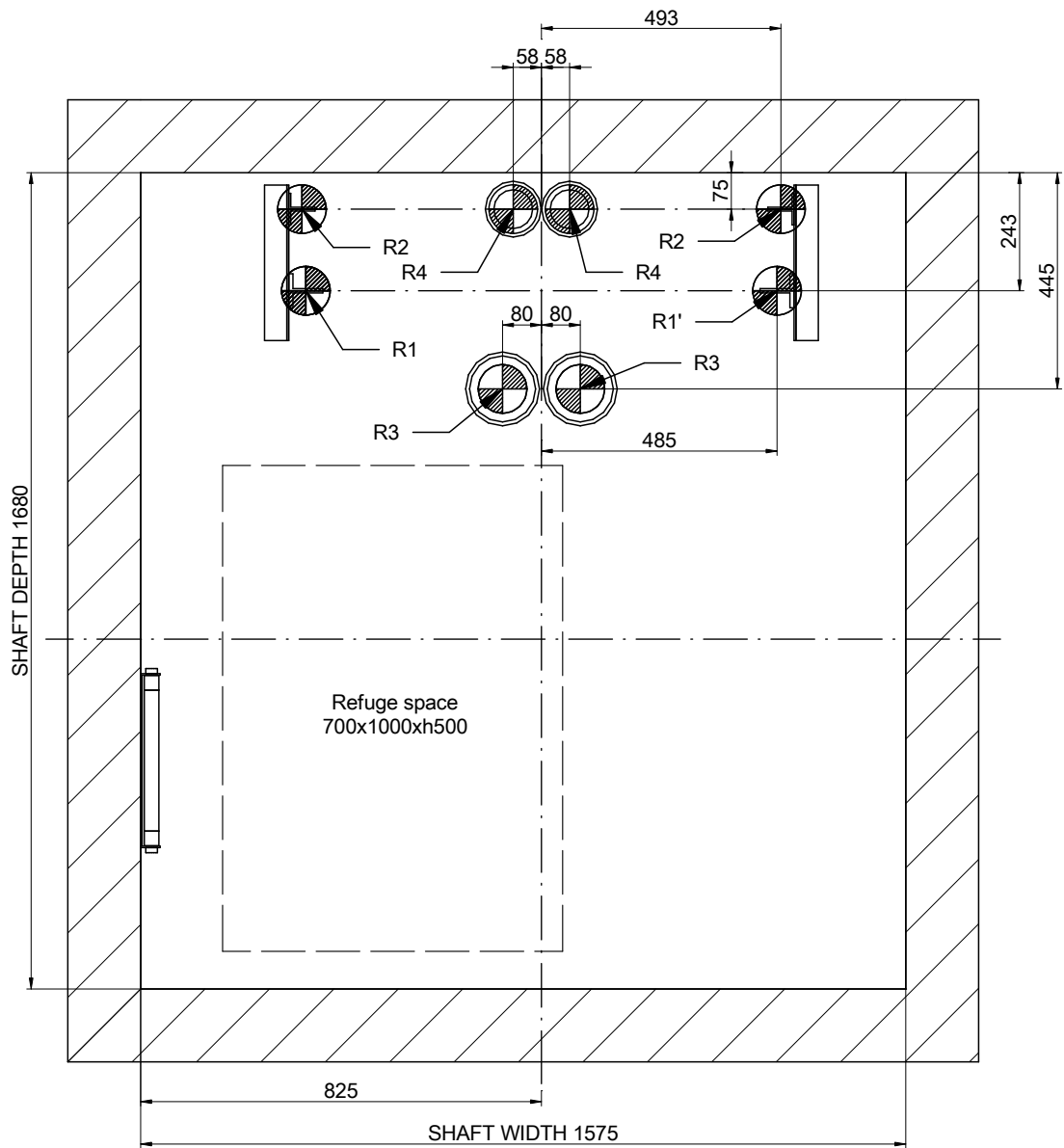



SCALE[\*]: 1:15

REACTIONS [N] [max.]			
R1	25000	R2	1000
R1'	25000	R2'	1000
R3	30000	R4	23700
N	4500	T	1100

DRAWING	DATE	REV.	SHEET	[*] Unbounded dimensions in drawings are indicative and not binding.	
MP	2016	00	6/8		
MODEL LIFT:				REFERENCE:	<p>CLIENT:</p> <p>WORK SITUATION:</p>
MP GO! FLEX				MPGO!FLEXFONDO630S_EN	
CAPACITY: [N° PERSONS]			8	<p><b>MP LIFTS</b></p>	
NOMINAL LOAD: [kg]			630		
SPEED: [m/s]			1		
FREQUENCY: [Hz]			50		
TENSION: [V]			380V [Three-phase]		

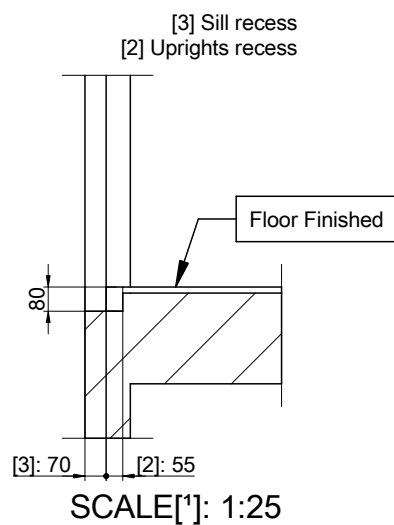
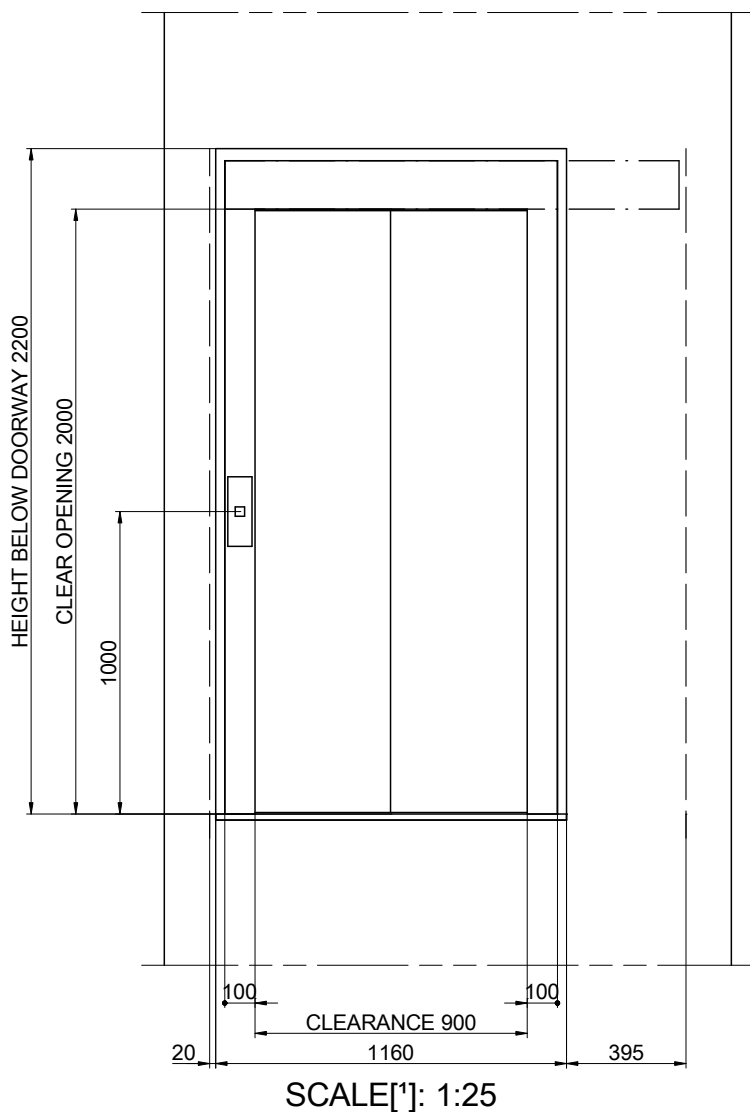
# 06-DOOR HOLE DETAIL



DRAWING	DATE	REV.	SHEET	[*] Unbounded dimensions in drawings are indicative and not binding.	
MP	2016	00	7/8	REFERENCE: MPGO!FLEXFONDO630S_EN	
MODEL LIFT:				CLIENT: WORK SITUATION:	
MP GO! FLEX					
CAPACITY: [N° PERSONS]		8			
NOMINAL LOAD: [kg]		630			
SPEED: [m/s]		1			
FREQUENCY: [Hz]		50			
TENSION: [V]		380V [Three-phase]		<b>MP LIFTS</b>	

# 07-HEADROOM

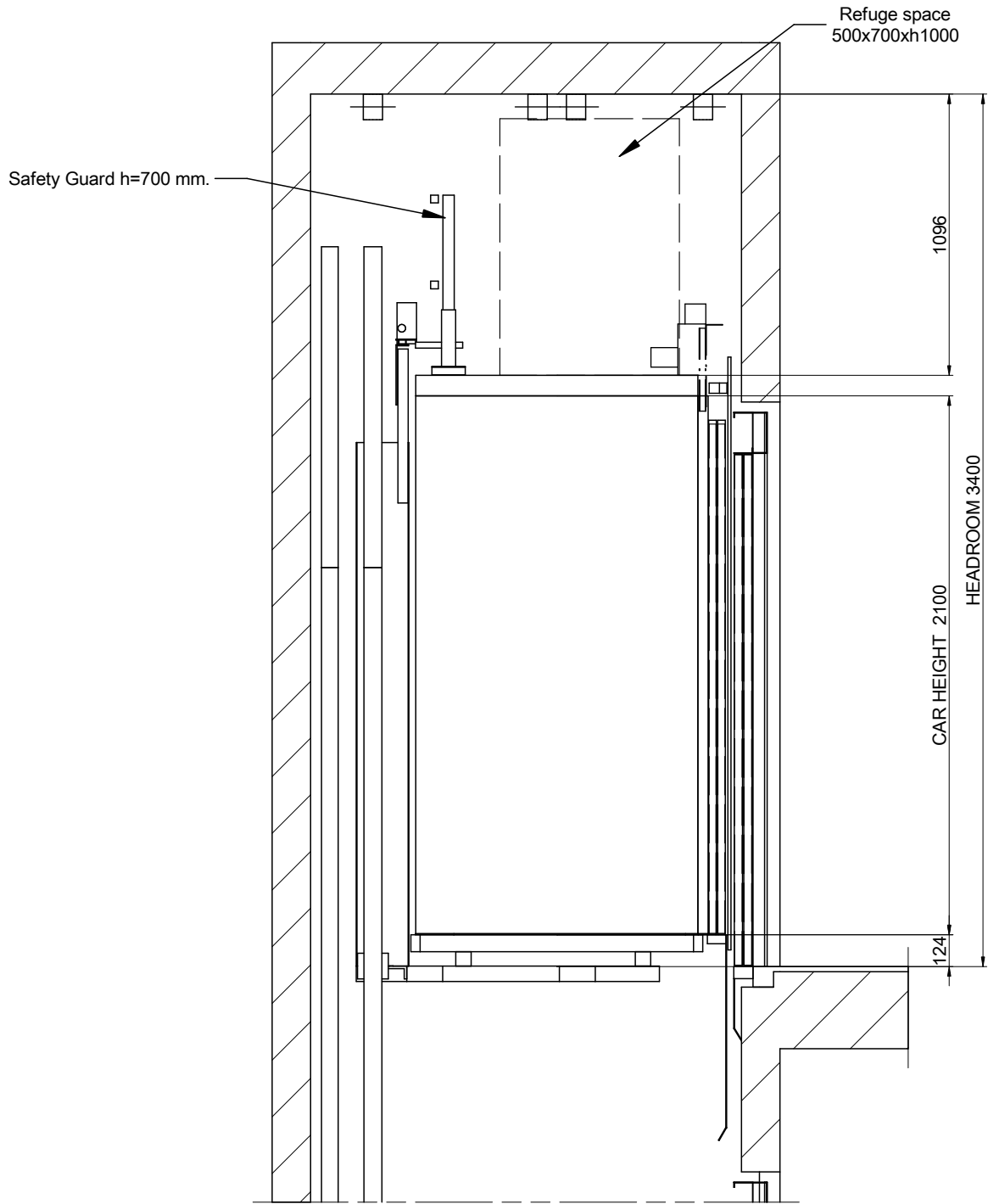

SCALE[\*]: 1:25

DRAWING	DATE	REV.	SHEET	[*] Unbounded dimensions in drawings are indicative and not binding.	
MP	2016	00	8/8	REFERENCE: MPGO!FLEXFONDO630S_EN	
MODEL LIFT:				CLIENT:	WORK SITUATION:
MP GO! FLEX					
CAPACITY: [N° PERSONS]			8	<h2>MP LIFTS</h2>	
NOMINAL LOAD: [kg]			630		
SPEED: [m/s]			1		
FREQUENCY: [Hz]			50		
TENSION: [V]			380V [Three-phase]		