

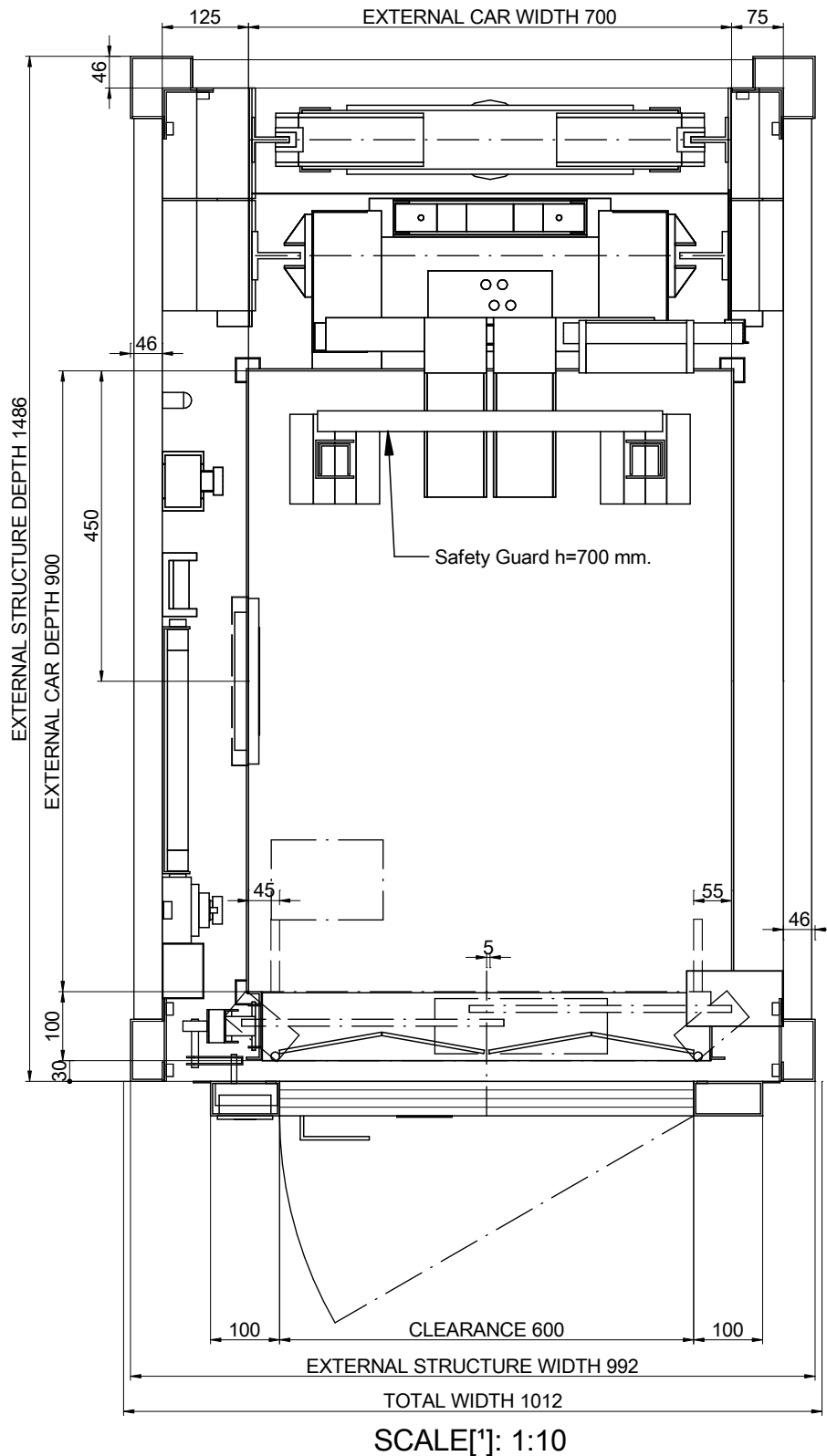

01-PLAN VIEW



DRAWING	DATE	REV.	SHEET	[*] Unbounded dimensions in drawings are indicative and not binding.	
MP	2016	00	1/8	REFERENCE: MPGO!FLEXFONDO225S_EN	
MODEL LIFT:				CLIENT:	
MP GO! FLEX				WORK SITUATION:	
CAPACITY: [N° PERSONS]			3		
NOMINAL LOAD: [kg]			225		
SPEED: [m/s]			1		
FREQUENCY: [Hz]			50		
TENSION: [V]			380V [Three-phase]	MP LIFTS	

01B-PLAN VIEW

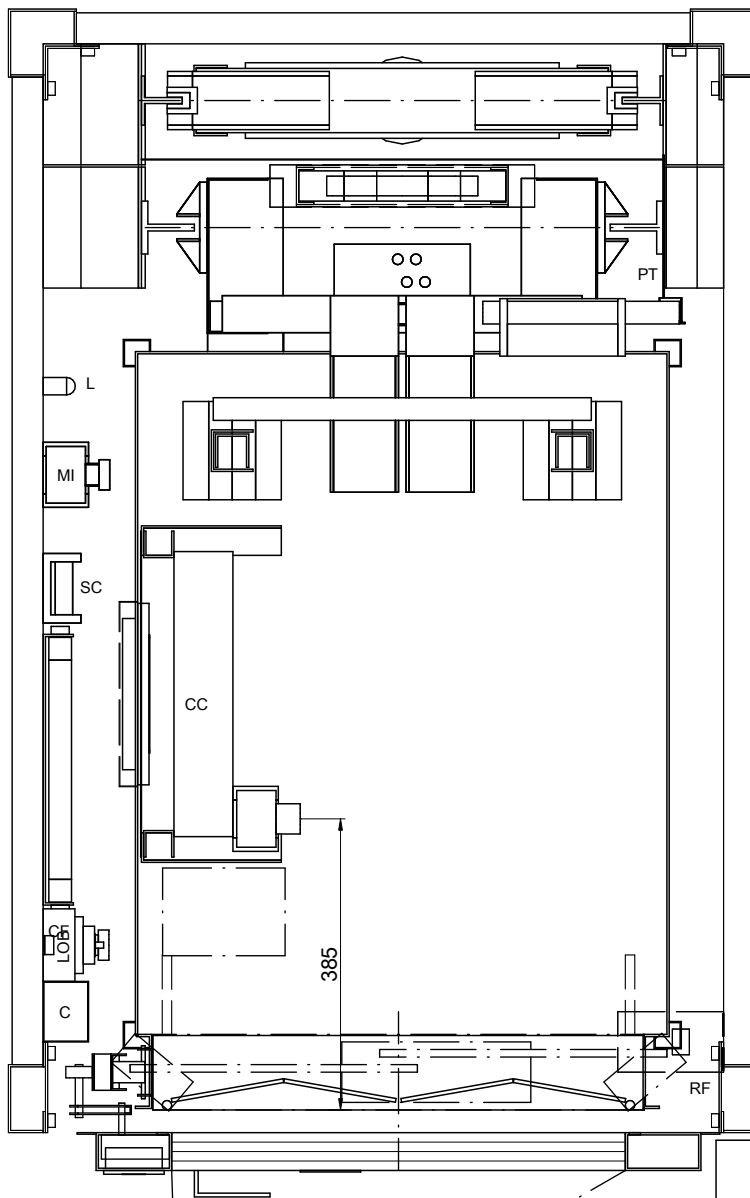

SCALE[*]: 1:10

ELECTRIC CABINET:
MP ecoGO
OPTIONAL ELECTRIC CABINET:
Via Serie (385x230x2160)

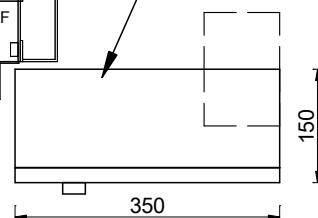

NOMENCLATURE

- C: Wiring channel
- CC: Car ceiling connection box
- CF: Pit box
- CL: Shaft light switch
- DOC: Operator control box
- L: Lamp
- LOB: Pushbutton control board
- MI: Inspection control station
- PT: Fixed cam
- RF: Brake resistor
- ST: Stopping device
- SC: Travelling cable support

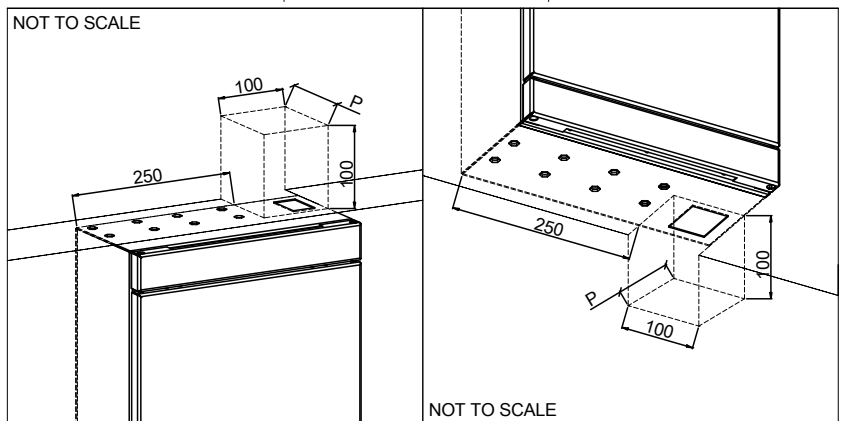

DRAWING	DATE	REV.	SHEET
MP	2016	00	2/8
MODEL LIFT:			
MP GO! FLEX			
CAPACITY: [N° PERSONS]			3
NOMINAL LOAD: [kg]			225
SPEED: [m/s]			1
FREQUENCY: [Hz]			50
TENSION: [V]		380V [Three-phase]	

[*] Unbounded dimensions in drawings are indicative and not binding.

REFERENCE:
MPGO!FLEXFONDO225S_EN



CLIENT:
WORK SITUATION:

MP LIFTS

02-SIDE VERTICAL SECTION

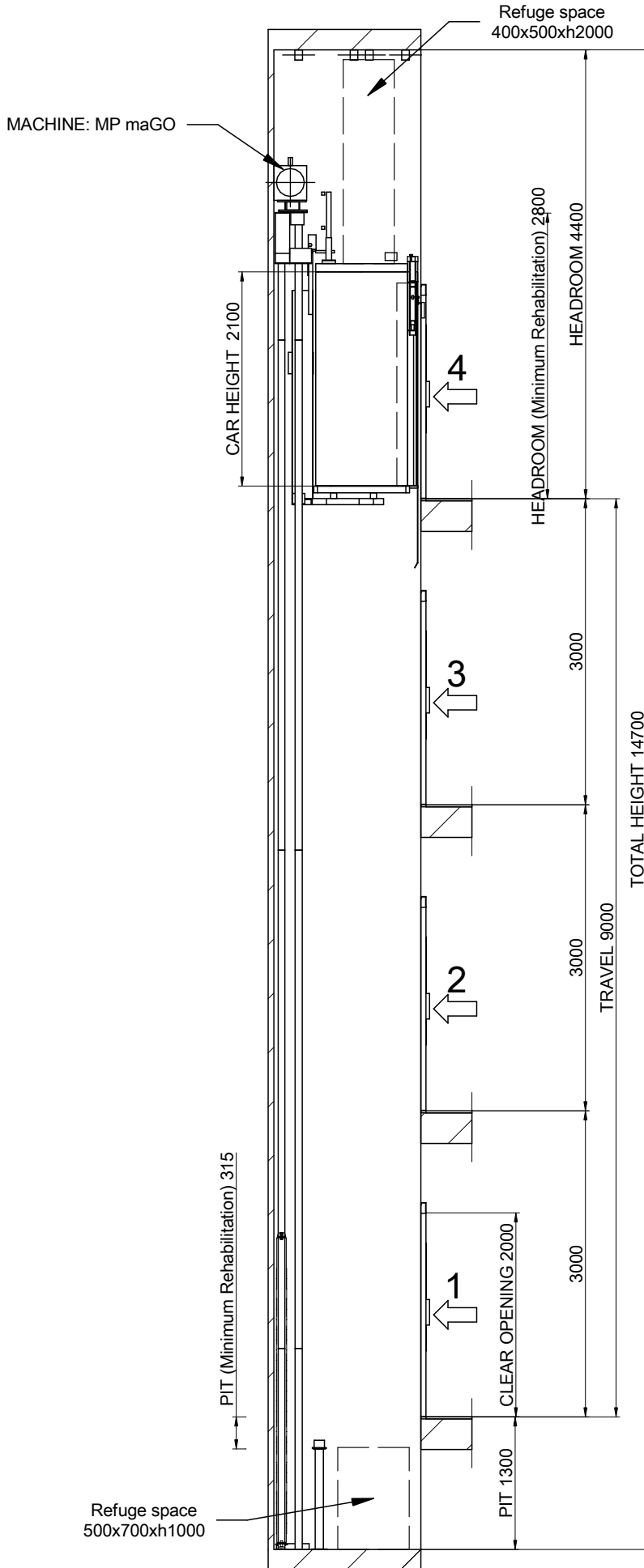

SCALE[*]: 1:60

		[*] Unbounded dimensions in drawings are indicative and not binding.	
		REFERENCE: MPGOIFLEXFONDO225S_EN	
DRAWING	DATE	REV.	SHEET
MP	2016	00	3/8
MODEL LIFT:			
MP GO! FLEX			
CAPACITY: [N° PERSONS]		3	
NOMINAL LOAD: [kg]		225	
SPEED: [m/s]		1	
FREQUENCY: [Hz]		50	
TENSION: [V]		380V [Three-phase]	
CLIENT: WORK SITUATION:			MP LIFTS

Flat and levelled floor, protected against water leaking.
 [EN81-20:2014 5.2.1.9]
 Foresee pit access device
 [EN81-20:2014 5.2.2.4]
 Stop device
 [EN81-20:2014 5.2.1.5.1. a)
 Inspection control station.
 [EN81-20:2014 5.2.1.5.1. b)
 Power supply
 [EN81-20:2014 5.2.1.5.1. c)
 Light switch
 commuted with the cabinet.
 [EN81-20:2014 5.2.1.5.1. d)

03B-FIXING DETAILS IN HEADROOM

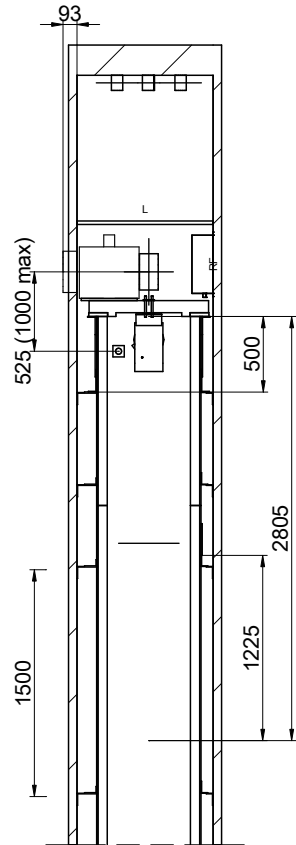

SCALE[*]: 1:50

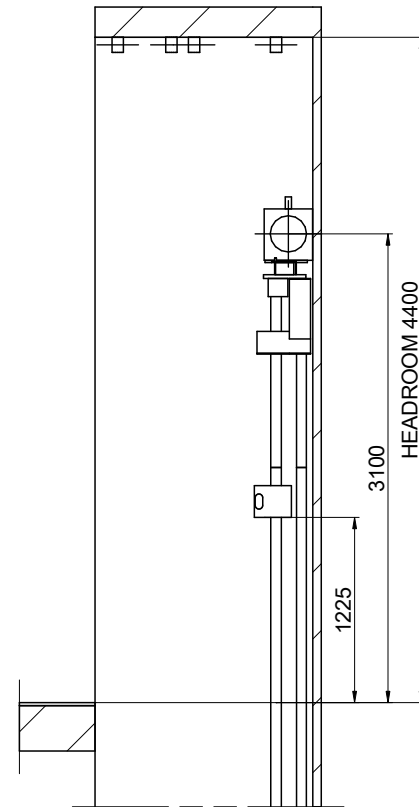

SCALE[*]: 1:50

DRAWING	DATE	REV.	SHEET	[*] Unbounded dimensions in drawings are indicative and not binding.	
MP	2016	00	4/8	REFERENCE: MPGO!FLEXFONDO225S_EN	
MODEL LIFT:				CLIENT: WORK SITUATION:	
MP GO! FLEX					
CAPACITY: [N° PERSONS]			3		
NOMINAL LOAD: [kg]			225		
SPEED: [m/s]			1		
FREQUENCY: [Hz]			50		
TENSION: [V]		380V [Three-phase]		MP LIFTS	



04-BEAM AND LIFTING HOOKS

POSITION OF REMOVABLE LIFTING HOOKS ABLE TO SUPPORT
1000 kg EACH ONE SUPPLIED BY CONSTRUCTOR
(RECOMMENDED POSITION LOADHOOKS)

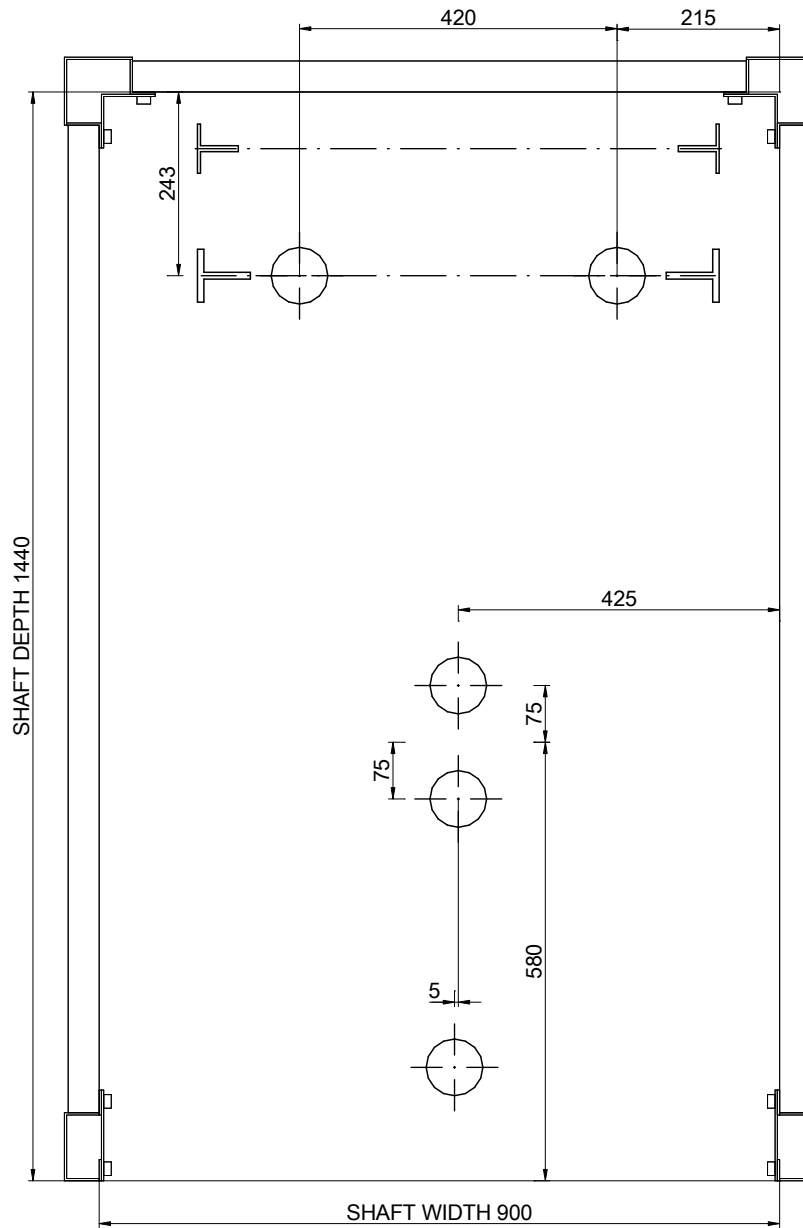

SCALE[*]: 1:10

DRAWING	DATE	REV.	SHEET	[*] Unbounded dimensions in drawings are indicative and not binding.	
MP	2016	00	5/8		
MODEL LIFT:				REFERENCE:	<p>MP LIFTS</p>
MP GO! FLEX				MPGO!FLEXFONDO225S_EN	
CAPACITY: [N° PERSONS]				CLIENT:	<p>MP LIFTS</p>
NOMINAL LOAD: [kg]				WORK SITUATION:	
SPEED: [m/s]					
FREQUENCY: [Hz]					
TENSION: [V]					
380V [Three-phase]					

05-PIT LAYOUT

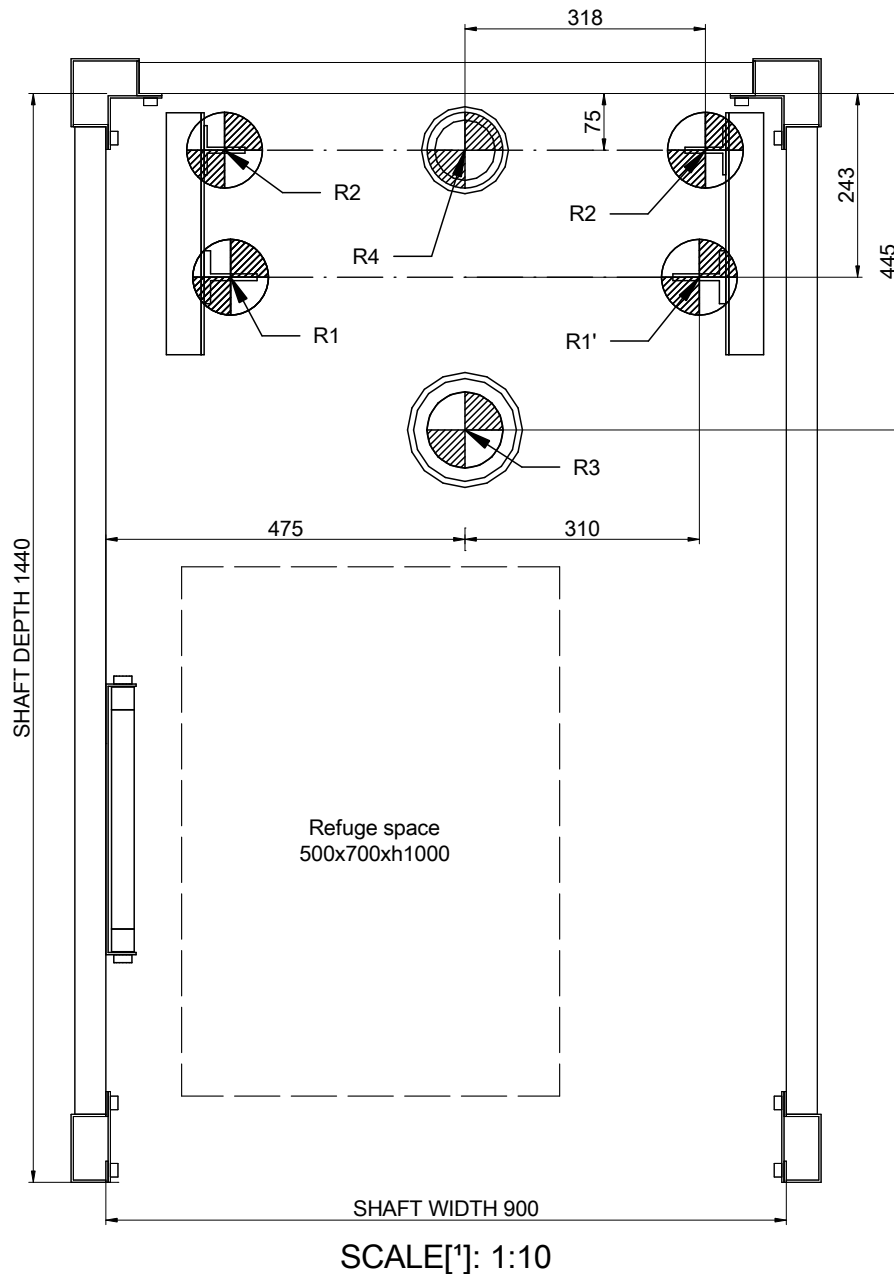

REACTIONS [N] [max.]			
R1	15000	R2	900
R1'	15000	R2'	900
R3	30000	R4	25500
N	1500	T	500

DRAWING	DATE	REV.	SHEET	['] Unbounded dimensions in drawings are indicative and not binding.	
MP	2016	00	6/8	REFERENCE: MPGO!FLEXFONDO225S_EN	
MODEL LIFT:				CLIENT:	WORK SITUATION:
MP GO! FLEX					
CAPACITY: [N° PERSONS]			3	<h2>MP LIFTS</h2>	
NOMINAL LOAD: [kg]			225		
SPEED: [m/s]			1		
FREQUENCY: [Hz]			50		
TENSION: [V]			380V [Three-phase]		

06-DOOR HOLE DETAIL

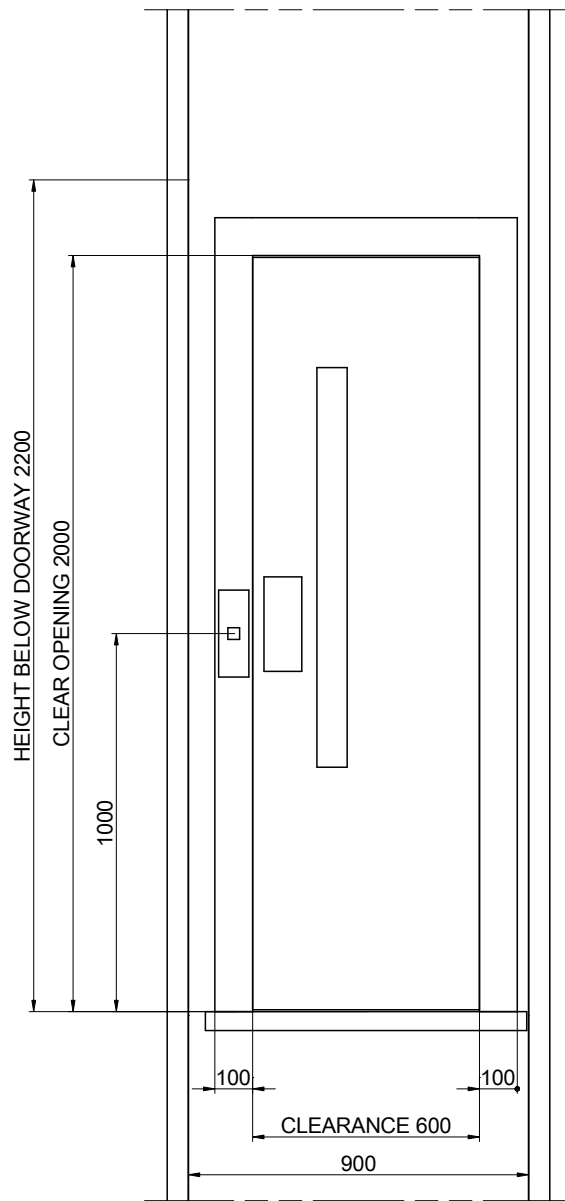

SCALE[*]: 1:20

DRAWING	DATE	REV.	SHEET	[*] Unbounded dimensions in drawings are indicative and not binding.	
MP	2016	00	7/8	REFERENCE: MPGO!FLEXFONDO225S_EN	
MODEL LIFT:				CLIENT:	WORK SITUATION:
MP GO! FLEX					
CAPACITY: [N° PERSONS]			3	<h2>MP LIFTS</h2>	
NOMINAL LOAD: [kg]			225		
SPEED: [m/s]			1		
FREQUENCY: [Hz]			50		
TENSION: [V]			380V [Three-phase]		

07-HEADROOM

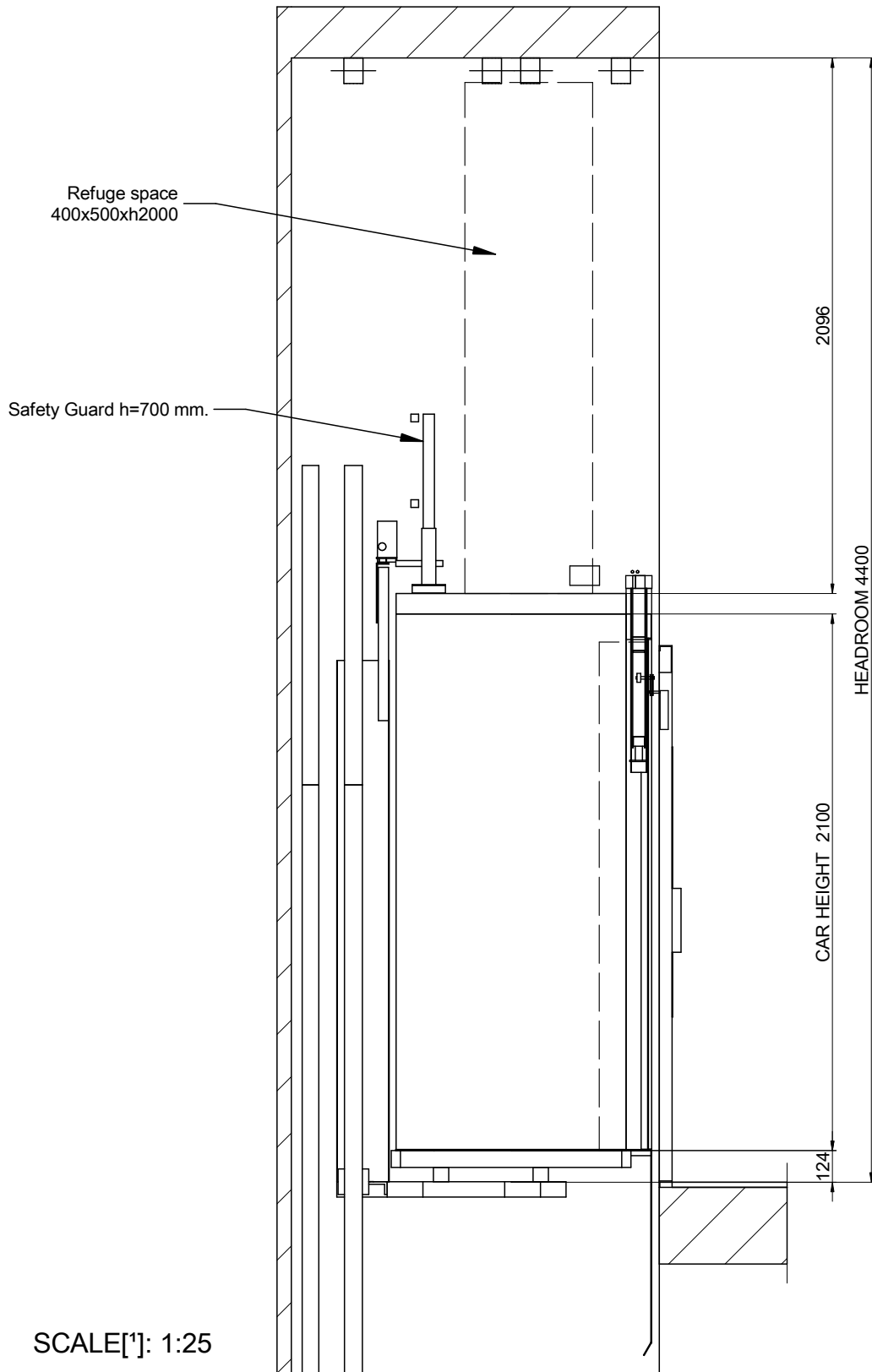

SCALE[*]: 1:25

DRAWING	DATE	REV.	SHEET	[*] Unbounded dimensions in drawings are indicative and not binding. REFERENCE: MPGO!FLEXFONDO225S_EN	
MP	2016	00	8/8		
MODEL LIFT:				CLIENT:	WORK SITUATION:
MP GO! FLEX					
CAPACITY: [N° PERSONS]			3	MP LIFTS	
NOMINAL LOAD: [kg]			225		
SPEED: [m/s]			1		
FREQUENCY: [Hz]			50		
TENSION: [V]			380V [Three-phase]		