

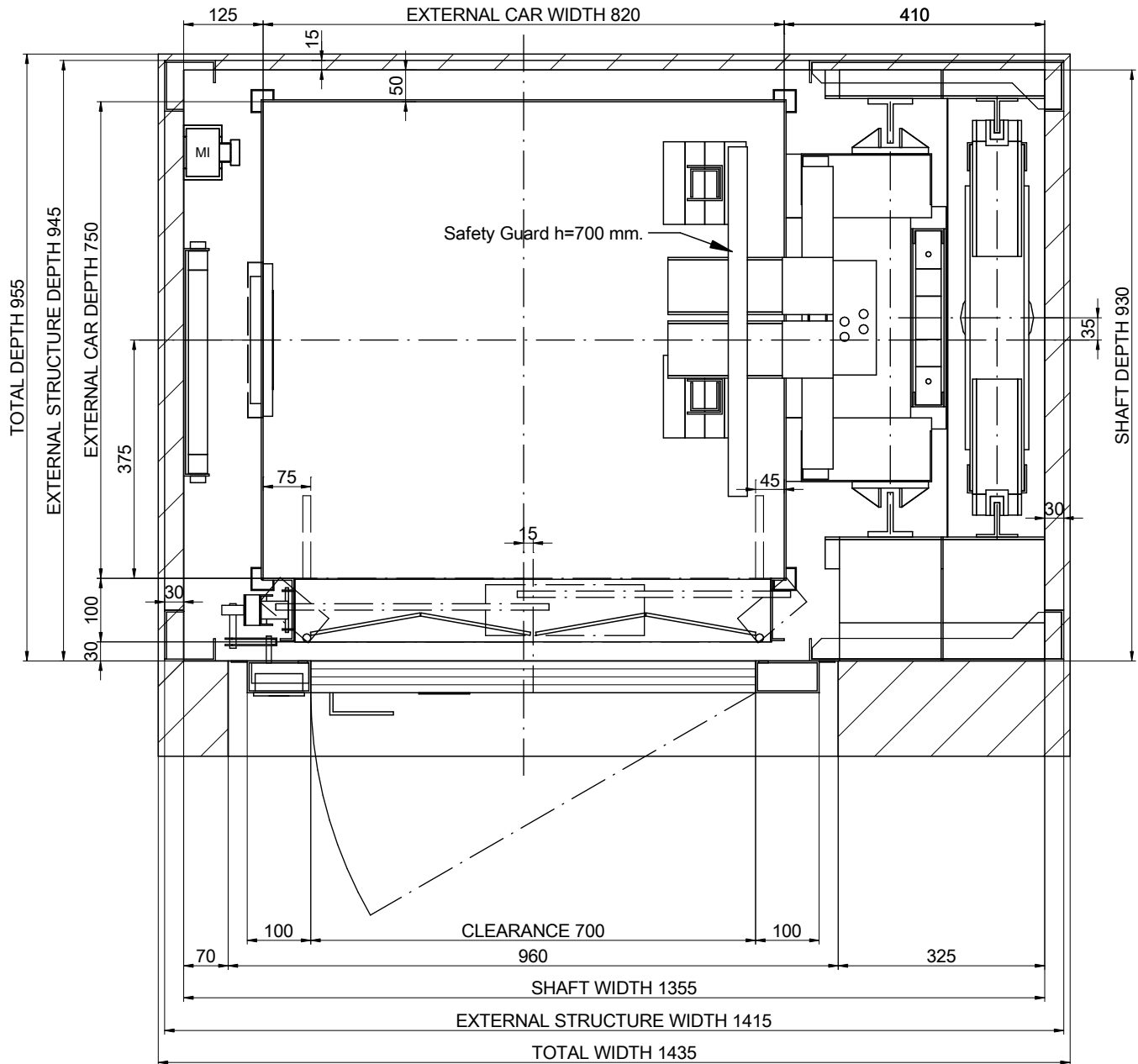

# 01-PLAN VIEW



SCALE[\*]: 1:10

## NOMENCLATURE

CC: Car ceiling connection box  
MI: Inspection control station

DRAWING	DATE	REV.	SHEET	[*] Unbounded dimensions in drawings are indicative and not binding. REFERENCE: MPGOIFLEXLATERAL225C_EN	
MP	2017	00	1/7		
MODEL LIFT:				CLIENT:	
MP GO! FLEX					
CAPACITY: [N° PERSONS]			3	WORK SITUATION:	
NOMINAL LOAD: [kg]			225		
SPEED: [m/s]			1		
FREQUENCY: [Hz]			50		
TENSION: [V]			380V [Three-phase]		
				<b>MP LIFTS</b>	

# 02-SIDE VERTICAL SECTION

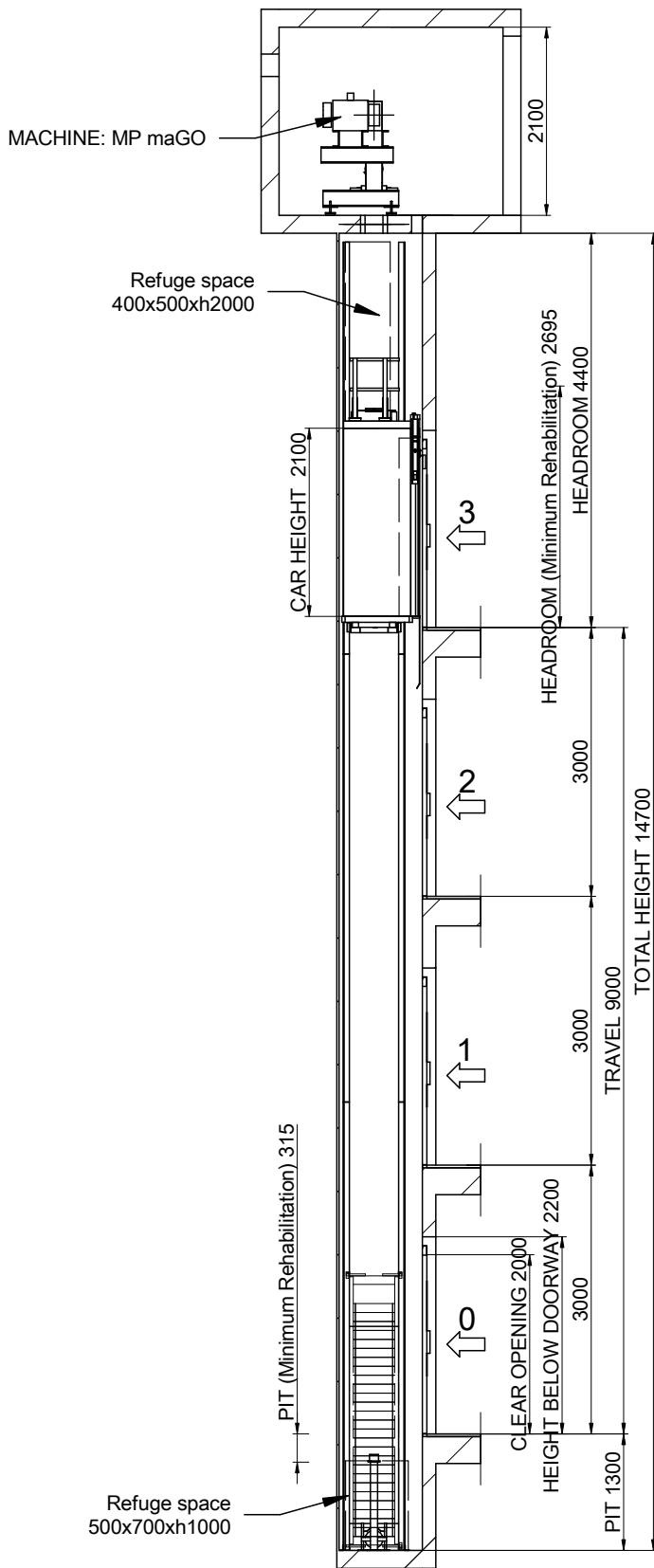

SCALE[\*]: 1:80

		[*] Unbounded dimensions in drawings are indicative and not binding.		
		REFERENCE: <b>MPGOIFLEXLATERAL225C_EN</b>		
DRAWING		DATE	REV.	SHEET
MP		2017	00	2/7
MODEL LIFT:		MP GO! FLEX		
CAPACITY: [N° PERSONS]		3		
NOMINAL LOAD: [kg]		225		
SPEED: [m/s]		1		
FREQUENCY: [Hz]		50		
TENSION: [V]		380V [Three-phase]		
CLIENT: WORK SITUATION:				<b>MP LIFTS</b>

Flat and levelled floor, protected against water leaking.  
 [EN81-20:2014 5.2.1.9]  
 Foresee pit access device  
 [EN81-20:2014 5.2.2.4]  
 Stop device  
 [EN81-20:2014 5.2.1.5.1. a]  
 Inspection control station.  
 [EN81-20:2014 5.2.1.5.1. b]  
 Power supply  
 [EN81-20:2014 5.2.1.5.1. c]  
 Light swicht  
 commuted with the cabinet.  
 [EN81-20:2014 5.2.1.5.1. d]

# 04-SLAB LAYOUT

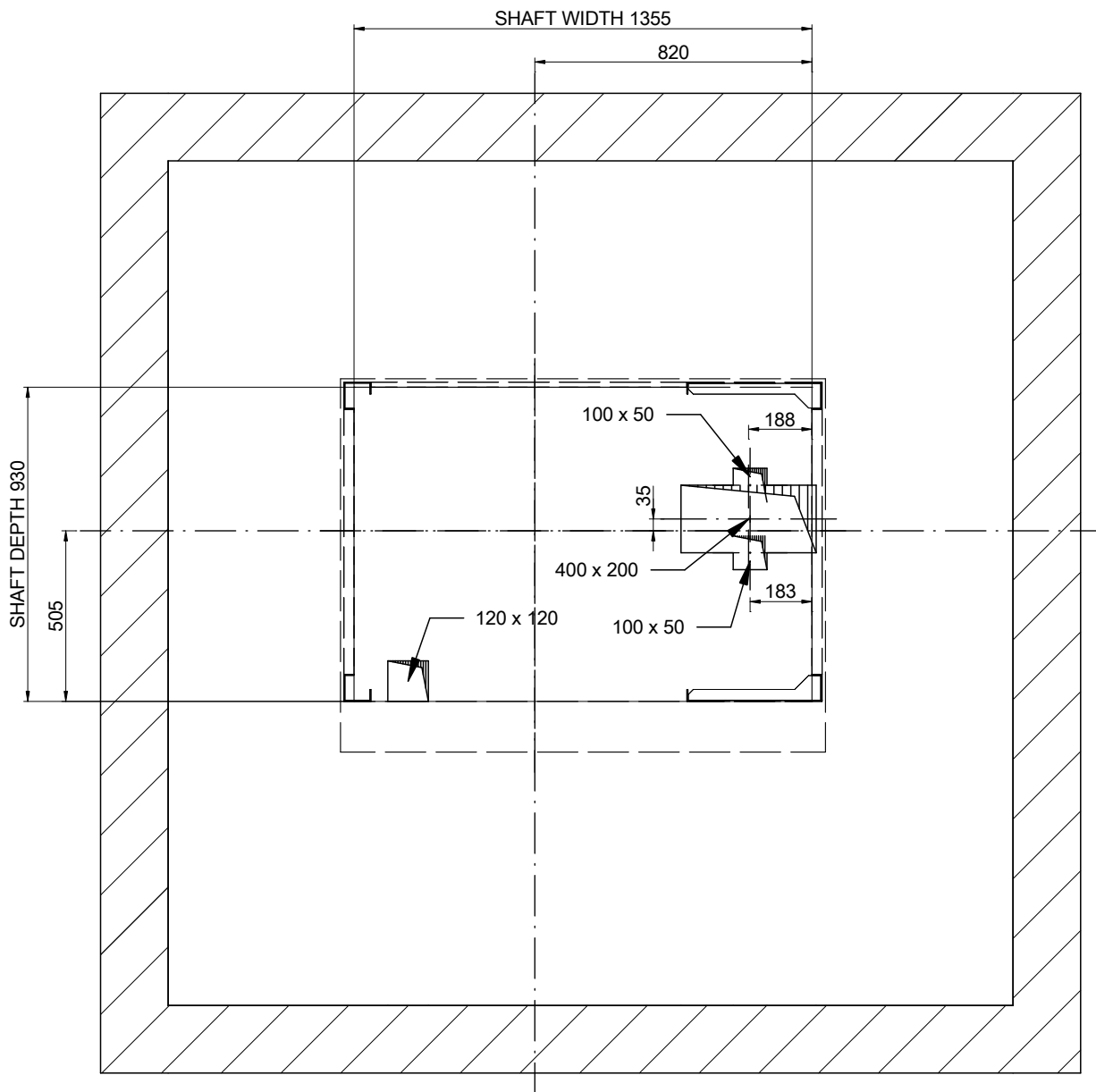

SCALE[\*]: 1:20

DRAWING	DATE	REV.	SHEET	[*] Unbounded dimensions in drawings are indicative and not binding. REFERENCE: MPGOIFLEXLATERAL225C_EN	
MP	2017	00	3/7		
MODEL LIFT:				CLIENT: WORK SITUATION:	<p><b>MP LIFTS</b></p>
<b>MP GO! FLEX</b>					
CAPACITY: [N° PERSONS]			3		
NOMINAL LOAD: [kg]			225		
SPEED: [m/s]			1		
FREQUENCY: [Hz]			50		
TENSION: [V]		380V [Three-phase]			

# 04B-MACHINE ROOM

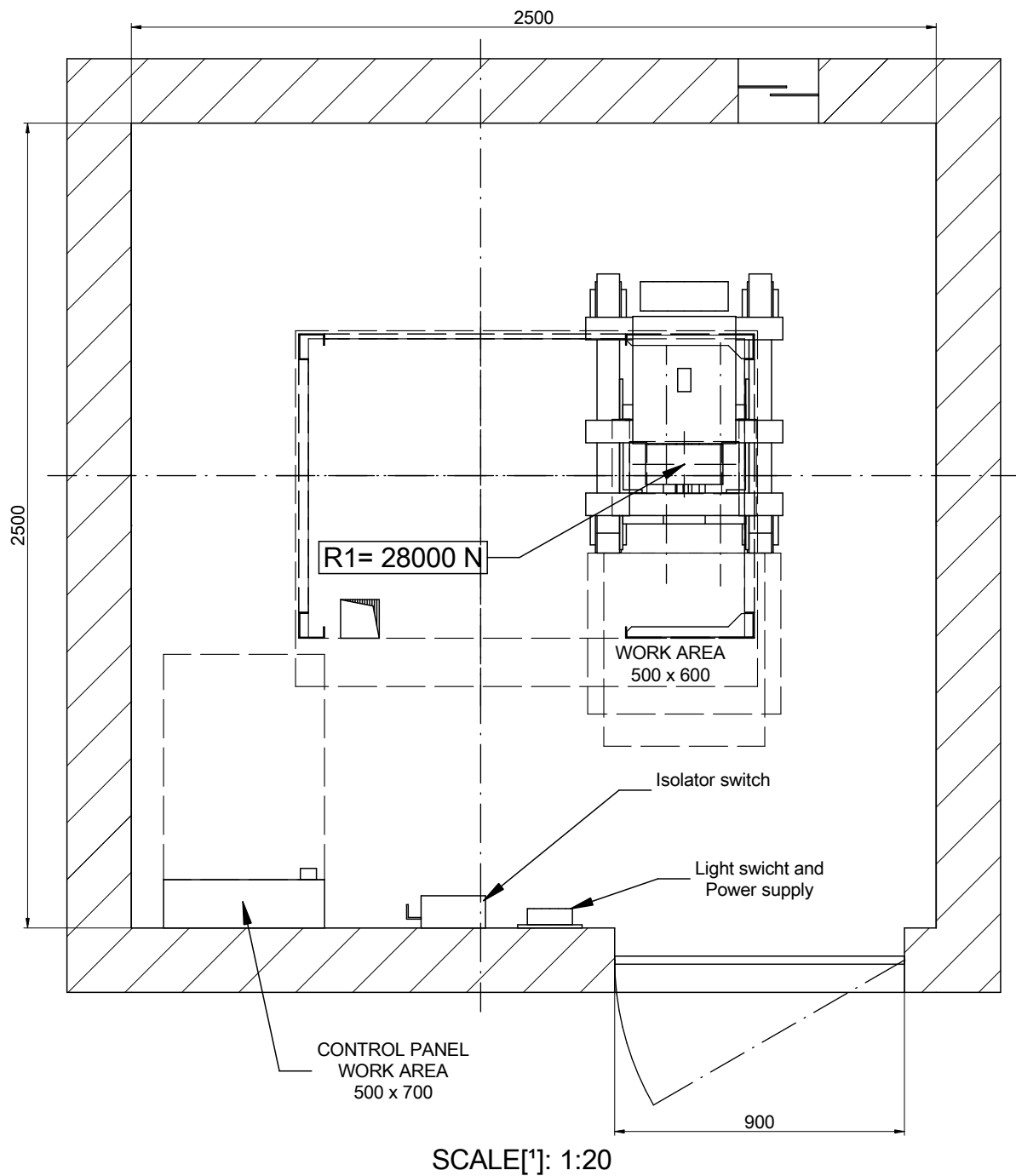

Minimum machine room height: 2100 mm.  
[EN 81-20:2014 5.2.6.3.2.1]  
Minimum clearance door: 600x2000 mm.  
[EN 81-20:2014 5.2.3.2 a]

DRAWING	DATE	REV.	SHEET	[*] Unbounded dimensions in drawings are indicative and not binding.	
MP	2017	00	4/7	REFERENCE: MPGO!FLEXLATERAL225C_EN	
MODEL LIFT:				CLIENT:	WORK SITUATION:
MP GO! FLEX					
CAPACITY: [N° PERSONS]			3	<h2>MP LIFTS</h2>	
NOMINAL LOAD: [kg]			225		
SPEED: [m/s]			1		
FREQUENCY: [Hz]			50		
TENSION: [V]			380V [Three-phase]		

# 05-PIT LAYOUT

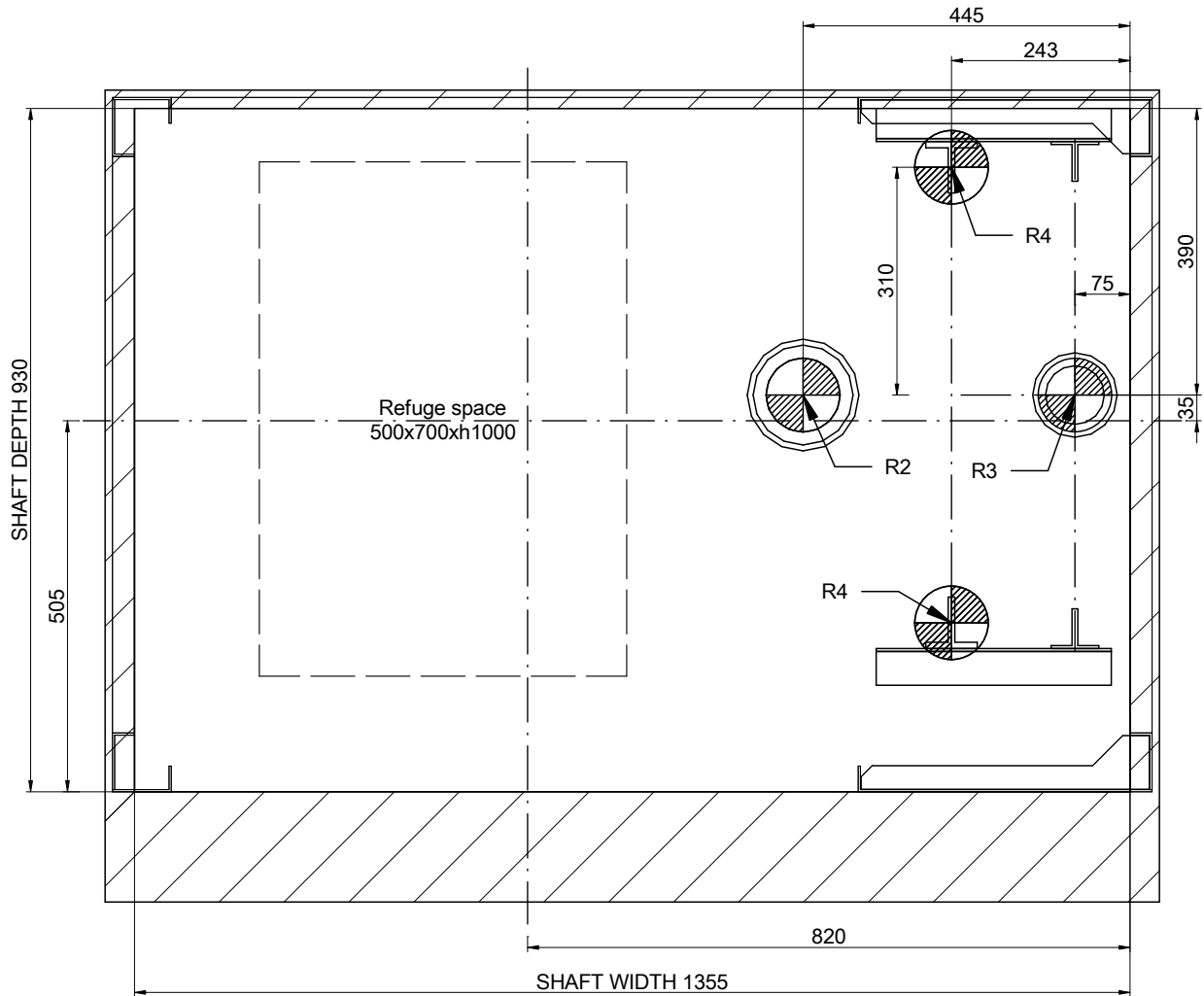

SCALE[']: 1:10

REACTIONS [N] [max.]			
R2	36500		
R3	30000	R4	11000
Sx	1900	Sy	300

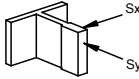

DRAWING	DATE	REV.	SHEET	[*] Unbounded dimensions in drawings are indicative and not binding.	
MP	2017	00	5/7	REFERENCE: MPGO!FLEXLATERAL225C_EN	
MODEL LIFT:				CLIENT:	WORK SITUATION:
MP GO! FLEX					
CAPACITY: [N° PERSONS]			3	<h2>MP LIFTS</h2>	
NOMINAL LOAD: [kg]			225		
SPEED: [m/s]			1		
FREQUENCY: [Hz]			50		
TENSION: [V]			380V [Three-phase]		

# 06-DOOR HOLE DETAIL

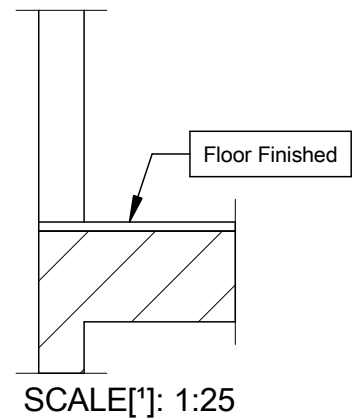
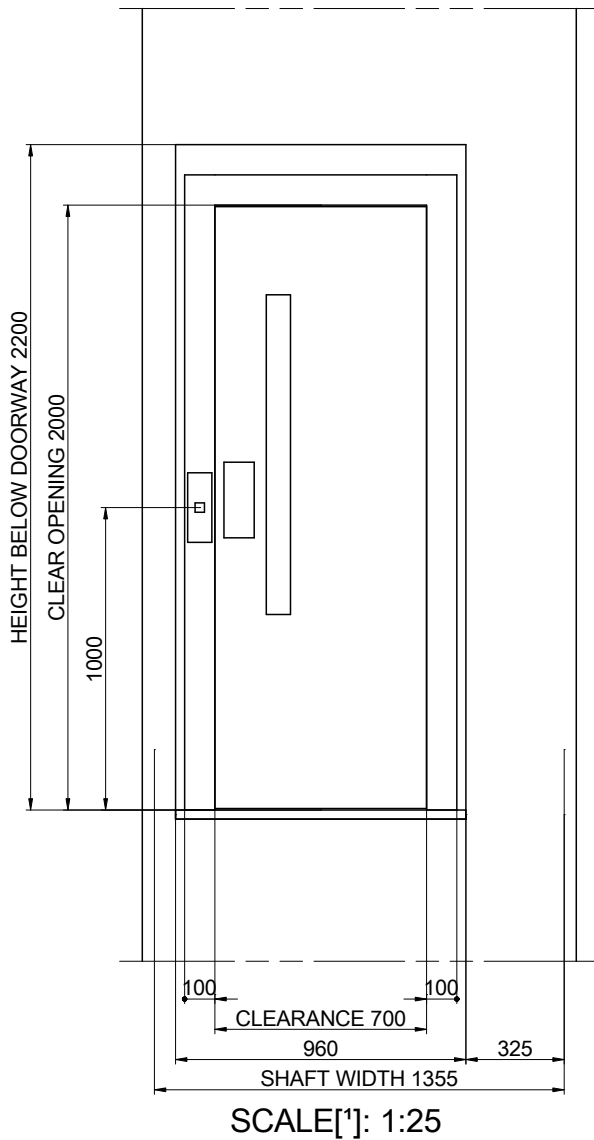

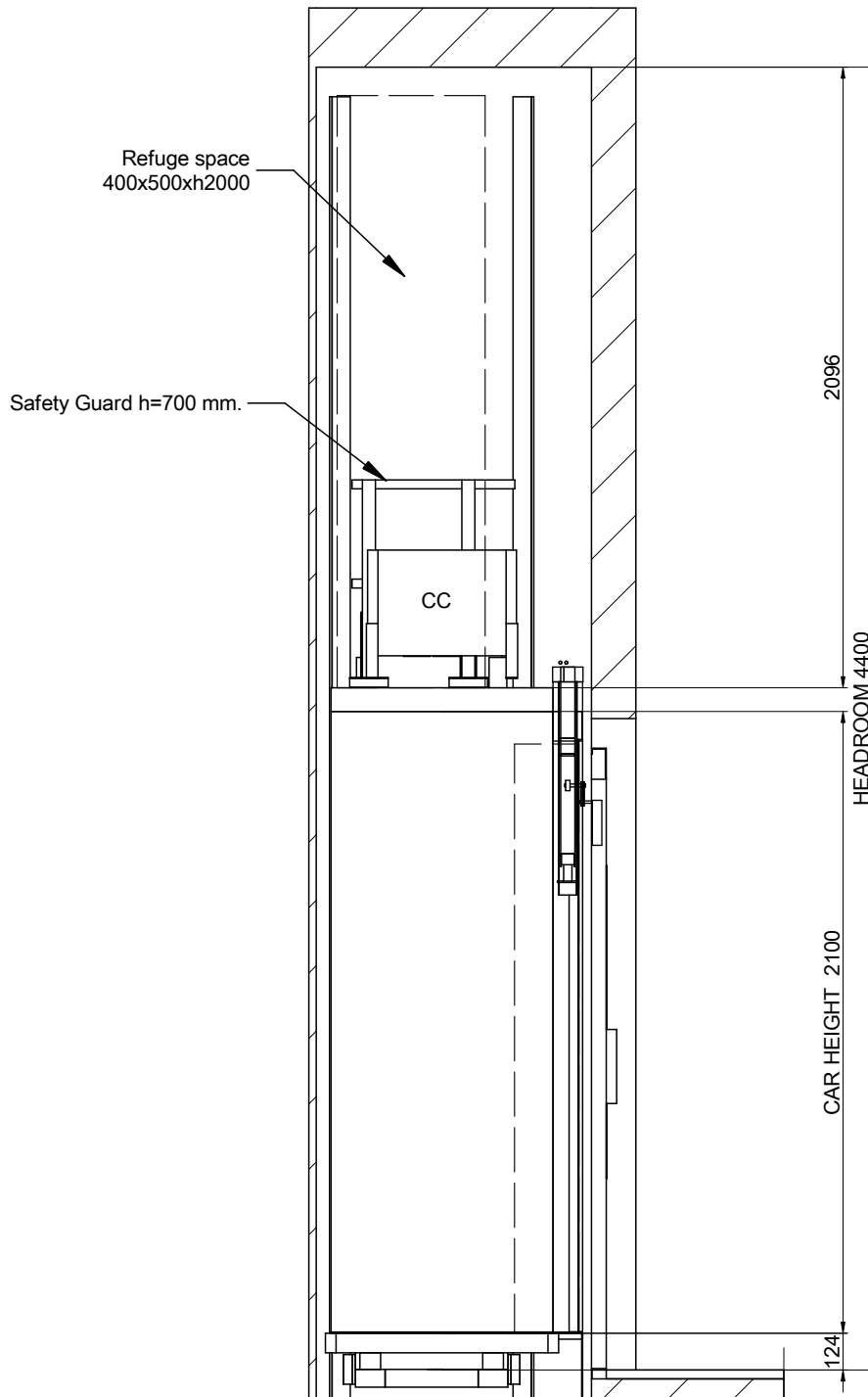

DRAWING	DATE	REV.	SHEET	[*] Unbounded dimensions in drawings are indicative and not binding.	
MP	2017	00	6/7	REFERENCE: MPGO!FLEXLATERAL225C_EN	
MODEL LIFT:				CLIENT: WORK SITUATION:	
MP GO! FLEX					
CAPACITY: [N° PERSONS]		3			
NOMINAL LOAD: [kg]		225			
SPEED: [m/s]		1			
FREQUENCY: [Hz]		50			
TENSION: [V]		380V [Three-phase]		<b>MP LIFTS</b>	

# 07-HEADROOM



SCALE[\*]: 1:25

DRAWING	DATE	REV.	SHEET	[*] Unbounded dimensions in drawings are indicative and not binding.		
MP	2017	00	7/7			
MODEL LIFT:				REFERENCE:		
MP GO! FLEX				MPGO!FLEXLATERAL225C_EN		
CAPACITY: [N° PERSONS]				3		CLIENT:
NOMINAL LOAD: [kg]				225		WORK SITUATION:
SPEED: [m/s]				1		
FREQUENCY: [Hz]				50		
TENSION: [V]				380V [Three-phase]		
					<b>MP LIFTS</b>	