

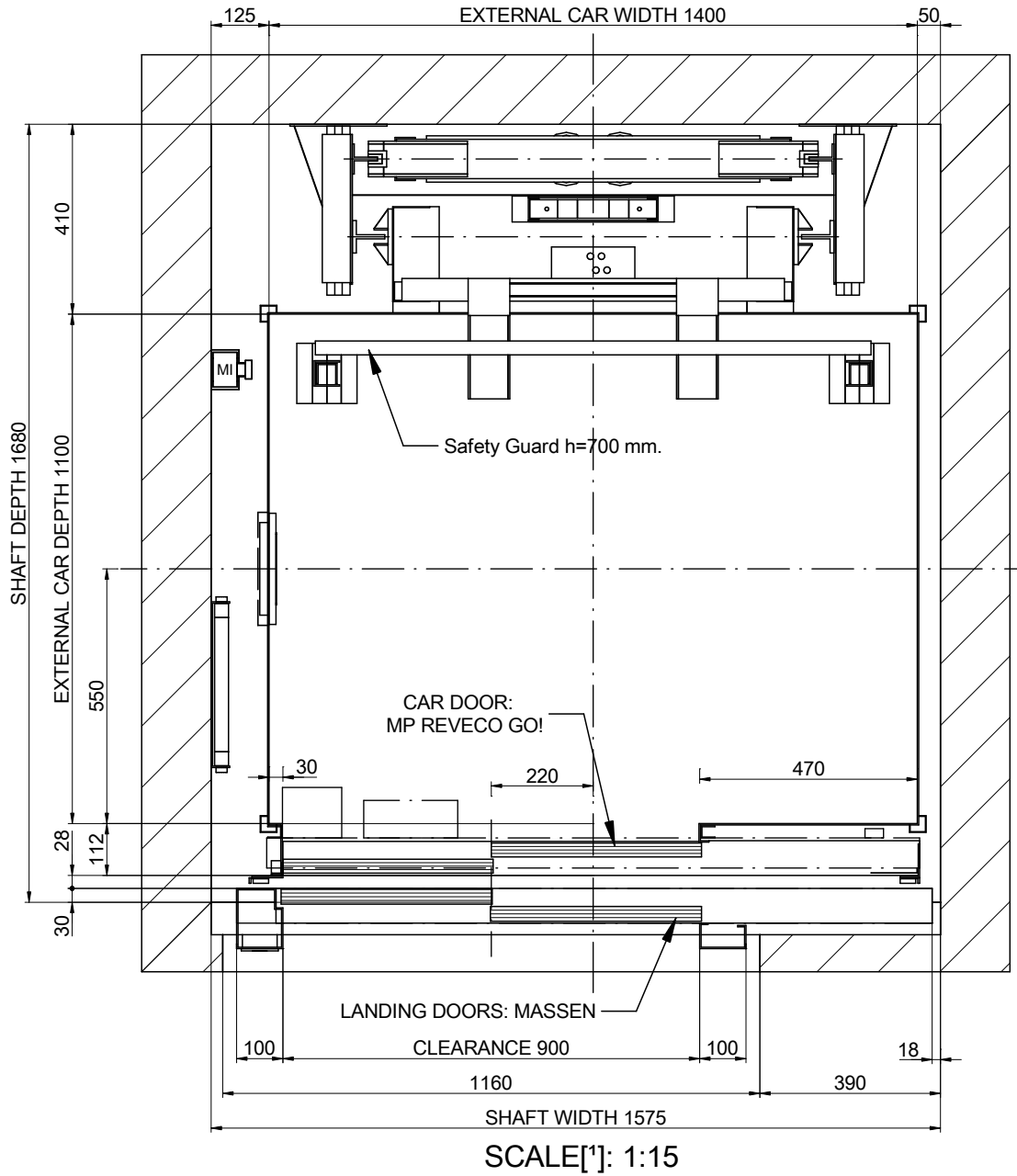

# 01-PLAN VIEW



## NOMENCLATURE

CC: Car ceiling connection box  
MI: Inspection control station

DRAWING	DATE	REV.	SHEET	[*] Unbounded dimensions in drawings are indicative and not binding.	
MP	2017	00	1/7	REFERENCE: MPGO!FLEXFONDO630C_EN	
MODEL LIFT:				CLIENT:	WORK SITUATION:
MP GO! FLEX					
CAPACITY: [N° PERSONS]			8	<h1>MP LIFTS</h1>	
NOMINAL LOAD: [kg]			630		
SPEED: [m/s]			1		
FREQUENCY: [Hz]			50		
TENSION: [V]			380V [Three-phase]		



# 04-SLAB LAYOUT

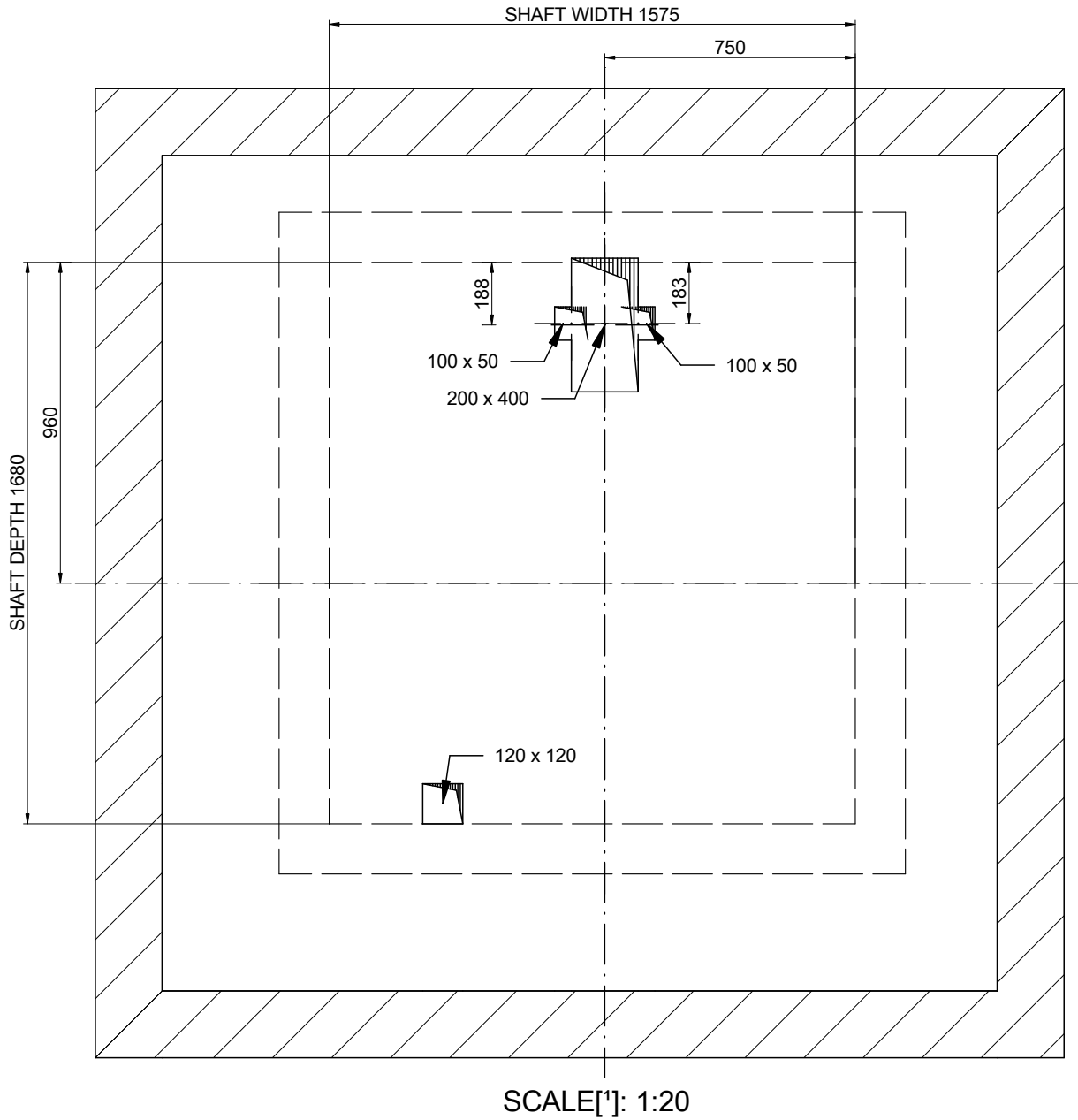

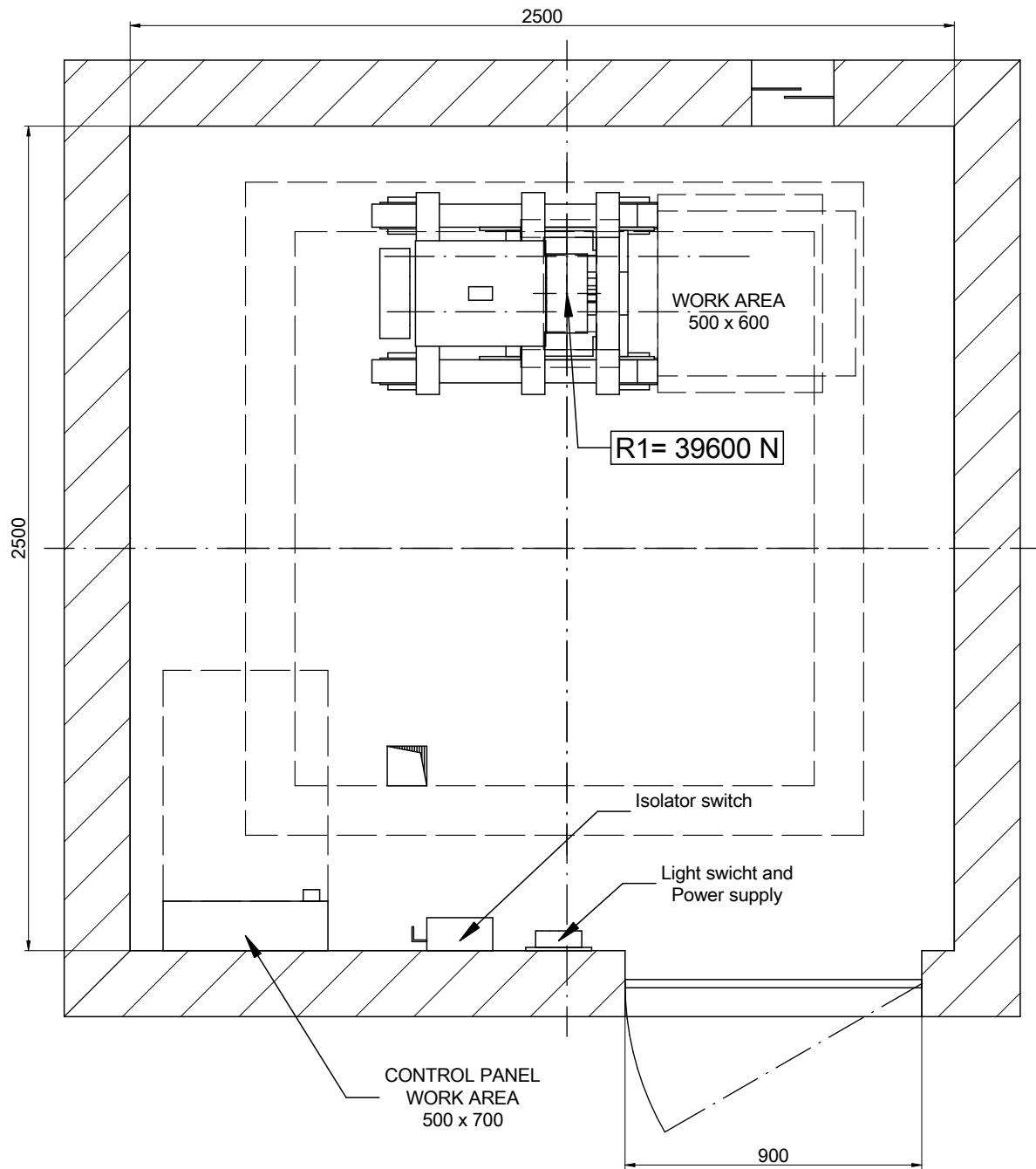

DRAWING	DATE	REV.	SHEET	[*] Unbounded dimensions in drawings are indicative and not binding.	
MP	2017	00	3/7	REFERENCE: MPGO!FLEXFONDO630C_EN	
MODEL LIFT:				CLIENT:	<b>MP LIFTS</b>
<b>MP GO! FLEX</b>				WORK SITUATION:	
CAPACITY: [N° PERSONS]			8		
NOMINAL LOAD: [kg]			630		
SPEED: [m/s]			1		
FREQUENCY: [Hz]			50		
TENSION: [V]		380V [Three-phase]			

# 04B-MACHINE ROOM



Minimum machine room height: 2100 mm.  
 [EN 81-20:2014 5.2.6.3.2.1]  
 Minimum clearance door: 600x2000 mm.  
 [EN 81-20:2014 5.2.3.2 a]

SCALE[\*]: 1:20

DRAWING	DATE	REV.	SHEET	[*] Unbounded dimensions in drawings are indicative and not binding.		
MP	2017	00	4/7			
MODEL LIFT:				REFERENCE:		
<b>MP GO! FLEX</b>				MPGO!FLEXFONDO630C_EN		
CAPACITY: [N° PERSONS]				8		CLIENT:
NOMINAL LOAD: [kg]				630		WORK SITUATION:
SPEED: [m/s]				1		
FREQUENCY: [Hz]				50		
TENSION: [V]				380V [Three-phase]		<b>MP LIFTS</b>

# 05-PIT LAYOUT

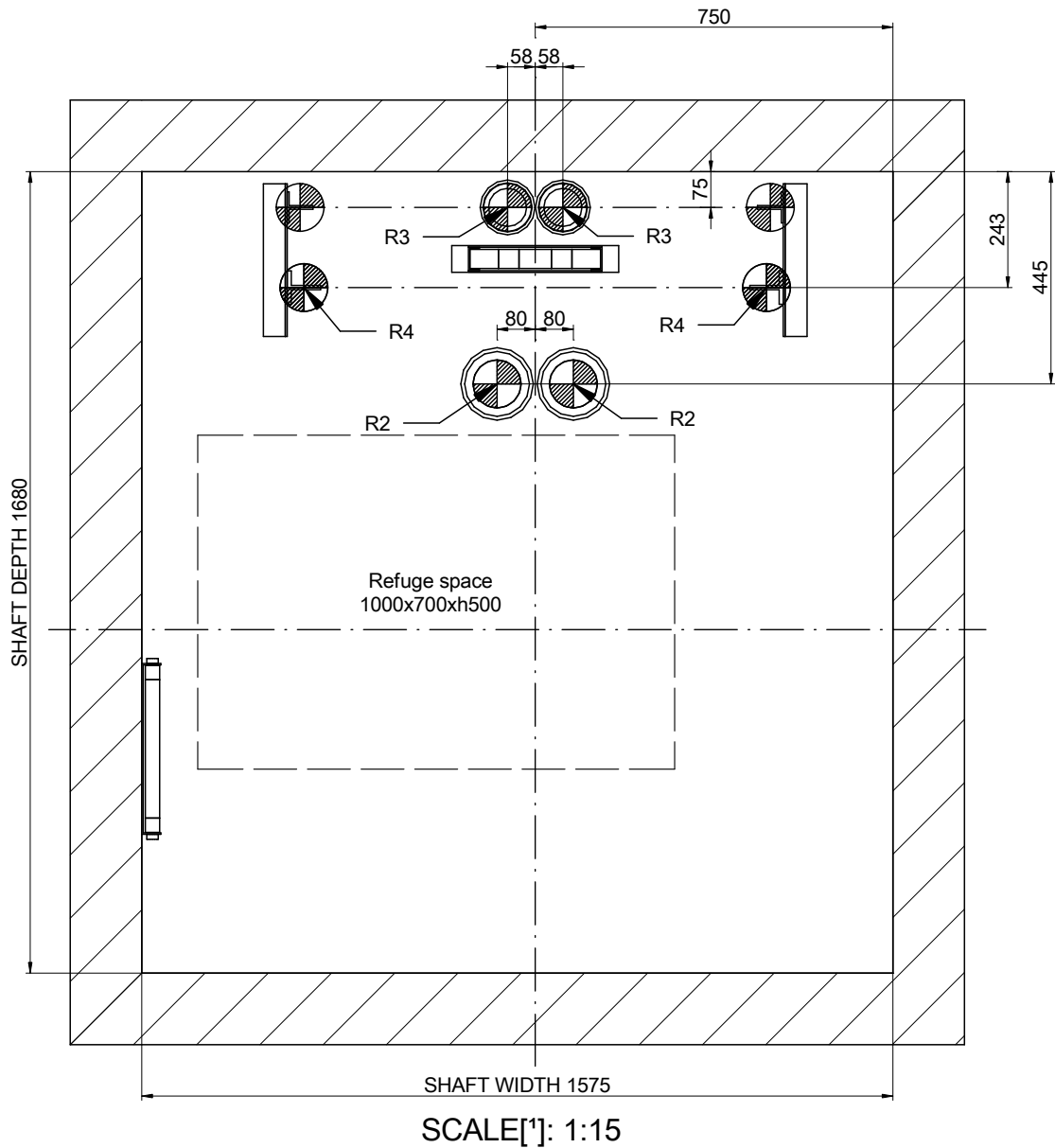

REACTIONS [N] [max.]			
R2	30900		
R3	23250	R4 16500	
Sx	5750	Sy 900	

DRAWING	DATE	REV.	SHEET	[*] Unbounded dimensions in drawings are indicative and not binding.	
MP	2017	00	5/7	REFERENCE: MPGO!FLEXFONDO630C_EN	
MODEL LIFT:				CLIENT: WORK SITUATION:	
MP GO! FLEX					
CAPACITY: [N° PERSONS]			8		
NOMINAL LOAD: [kg]			630		
SPEED: [m/s]			1		
FREQUENCY: [Hz]			50		
TENSION: [V]			380V [Three-phase]	<b>MP LIFTS</b>	

# 06-DOOR HOLE DETAIL

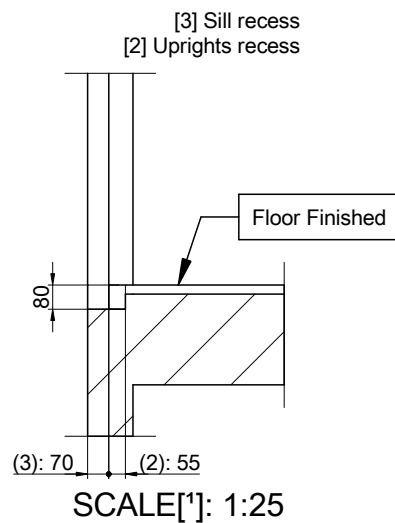
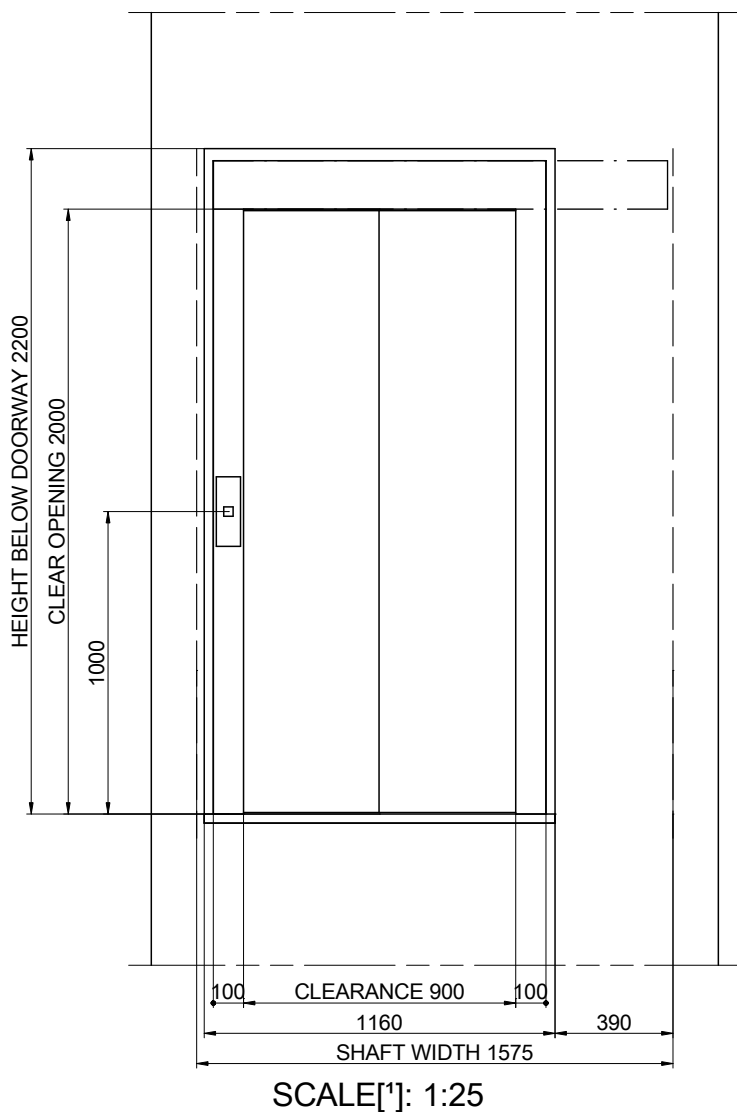

DRAWING	DATE	REV.	SHEET	[*] Unbounded dimensions in drawings are indicative and not binding. REFERENCE: MPGO!FLEXFONDO630C_EN	
MP	2017	00	6/7		
MODEL LIFT:				CLIENT:	WORK SITUATION:
MP GO! FLEX					
CAPACITY: [N° PERSONS]		8		<h2>MP LIFTS</h2>	
NOMINAL LOAD: [kg]		630			
SPEED: [m/s]		1			
FREQUENCY: [Hz]		50			
TENSION: [V]		380V [Three-phase]			

# 07-HEADROOM

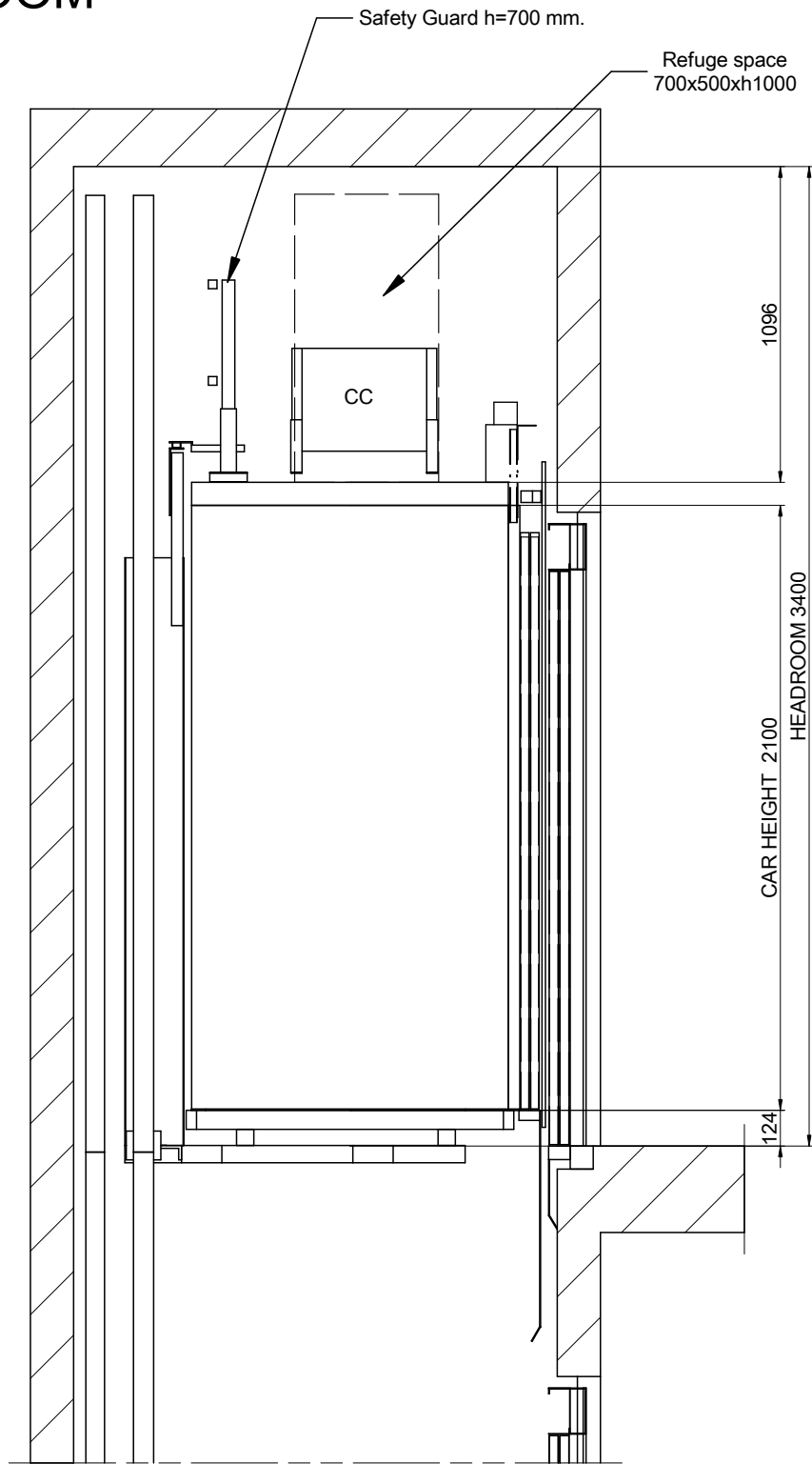

DRAWING	DATE	REV.	SHEET	[*] Unbounded dimensions in drawings are indicative and not binding.		
MP	2017	00	7/7			
MODEL LIFT:				REFERENCE:	<p>MP LIFTS</p>	
MP GO! FLEX				MPGO!FLEXFONDO630C_EN		
CAPACITY: [N° PERSONS]				8		CLIENT:
NOMINAL LOAD: [kg]				630		WORK SITUATION:
SPEED: [m/s]				1		
FREQUENCY: [Hz]				50		
TENSION: [V]				380V [Three-phase]		