

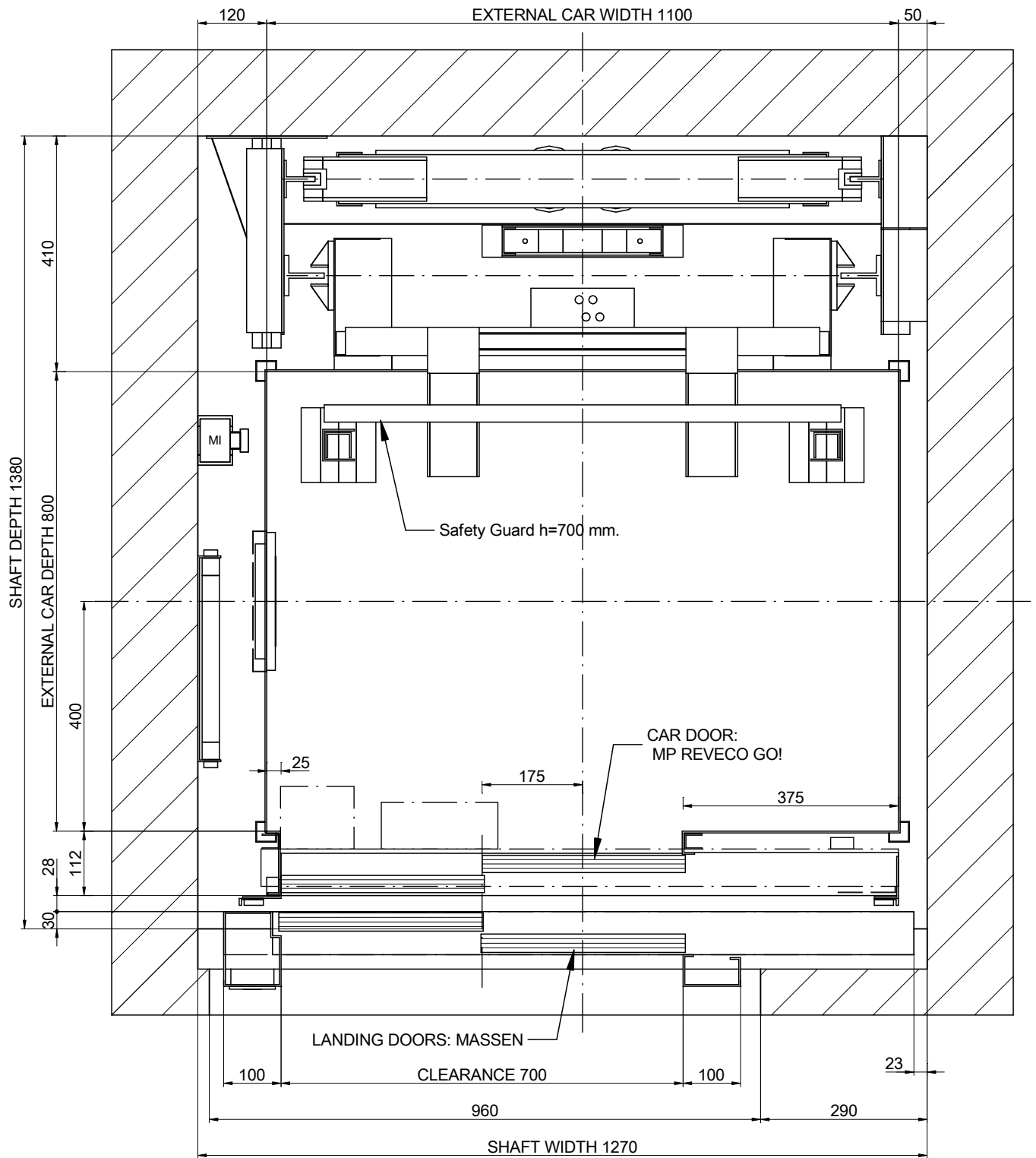

# 01-PLAN VIEW



SCALE[\*]: 1:10

## NOMENCLATURE

CC: Car ceiling connection box  
MI: Inspection control station

DRAWING	DATE	REV.	SHEET	[*] Unbounded dimensions in drawings are indicative and not binding.	
MP	2017	00	1/7	REFERENCE: MPGO!FLEXFONDO320C_EN	
MODEL LIFT:				CLIENT:	
MP GO! FLEX					
CAPACITY: [N° PERSONS]			4	WORK SITUATION:	
NOMINAL LOAD: [kg]			320		
SPEED: [m/s]			1		
FREQUENCY: [Hz]			50		
TENSION: [V]			380V [Three-phase]		

MP LIFTS

# 02-SIDE VERTICAL SECTION

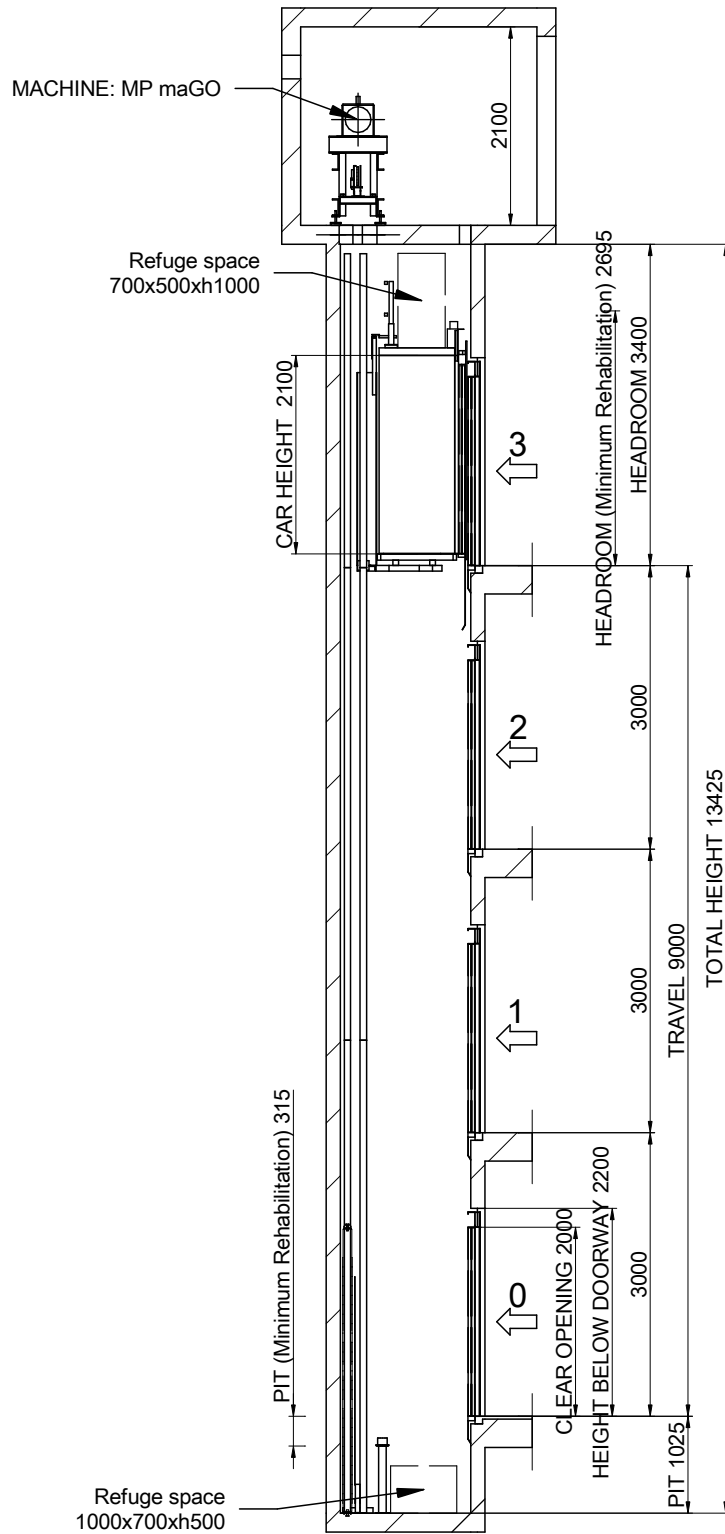

SCALE[\*]: 1:80

Flat and levelled floor, protected against water leaking.  
 [EN81-20:2014 5.2.1.9]  
 Foresee pit access device  
 [EN81-20:2014 5.2.2.4]  
 Stop device  
 [EN81-20:2014 5.2.1.5.1. a]  
 Inspection control station.  
 [EN81-20:2014 5.2.1.5.1. b]  
 Power supply  
 [EN81-20:2014 5.2.1.5.1. c]  
 Light swicht  
 commuted with the cabinet.  
 [EN81-20:2014 5.2.1.5.1. d]

DRAWING		DATE	REV.	SHEET	[*] Unbounded dimensions in drawings are indicative and not binding.
MP	2017	00	2/7	REFERENCE: MPGOIFLEXFONDO320C_EN	
MODEL LIFT:		MP GO! FLEX			CLIENT: WORK SITUATION:
CAPACITY: [N° PERSONS]		4			
NOMINAL LOAD: [kg]		320			
SPEED: [m/s]		1			
FREQUENCY: [Hz]		50			
TENSION: [V]		380V [Three-phase]			
<b>MP LIFTS</b>					



# 04-SLAB LAYOUT

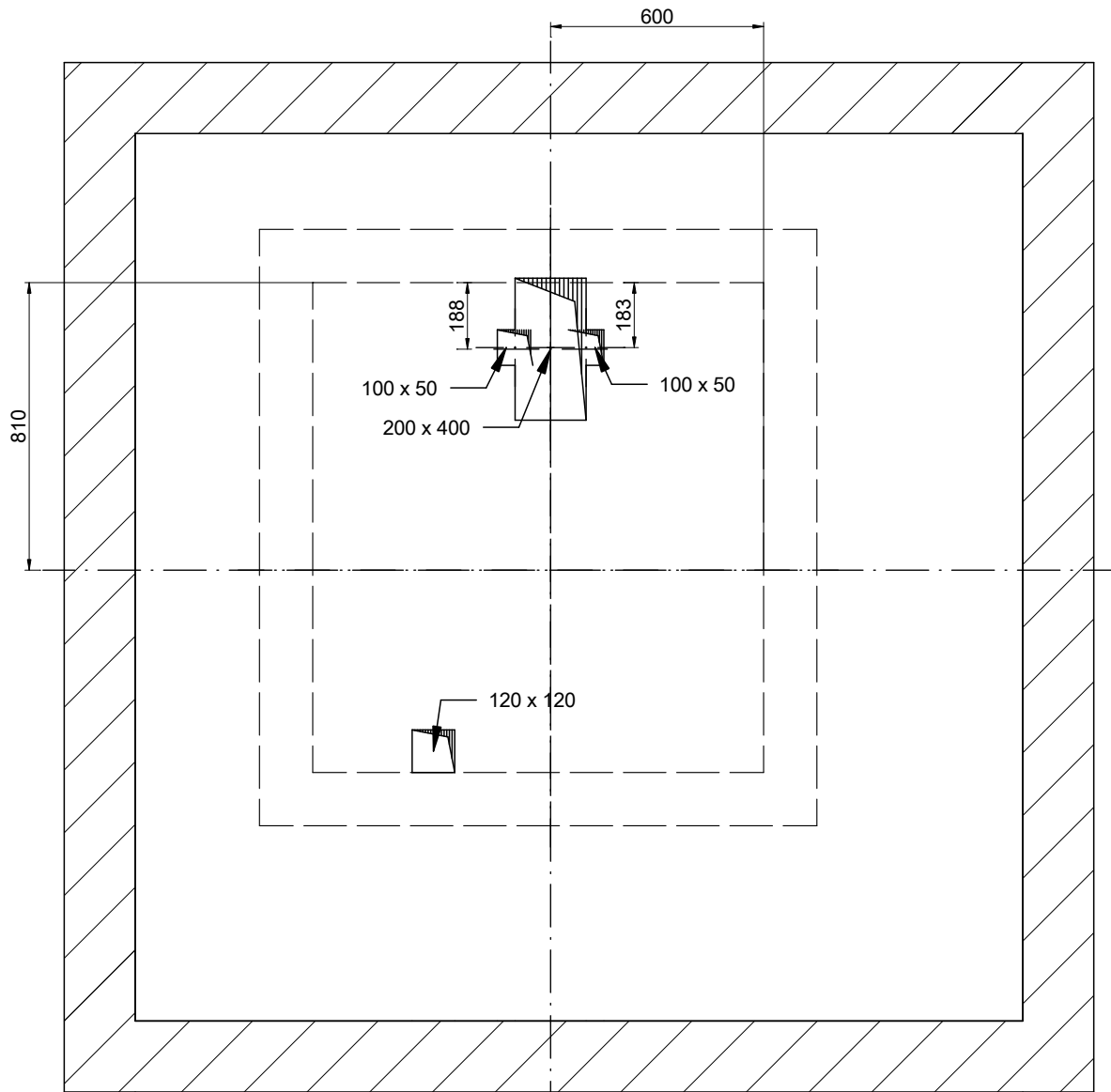

SCALE[\*]: 1:20

DRAWING	DATE	REV.	SHEET	[*] Unbounded dimensions in drawings are indicative and not binding.	
MP	2017	00	3/7	REFERENCE: MPGO!FLEXFONDO320C_EN	
MODEL LIFT:				CLIENT: WORK SITUATION:	<p style="text-align: center; font-size: 24px; font-weight: bold;">MP LIFTS</p>
<b>MP GO! FLEX</b>					
CAPACITY: [N° PERSONS]			4		
NOMINAL LOAD: [kg]			320		
SPEED: [m/s]			1		
FREQUENCY: [Hz]			50		
TENSION: [V]		380V [Three-phase]			

# 04B-MACHINE ROOM

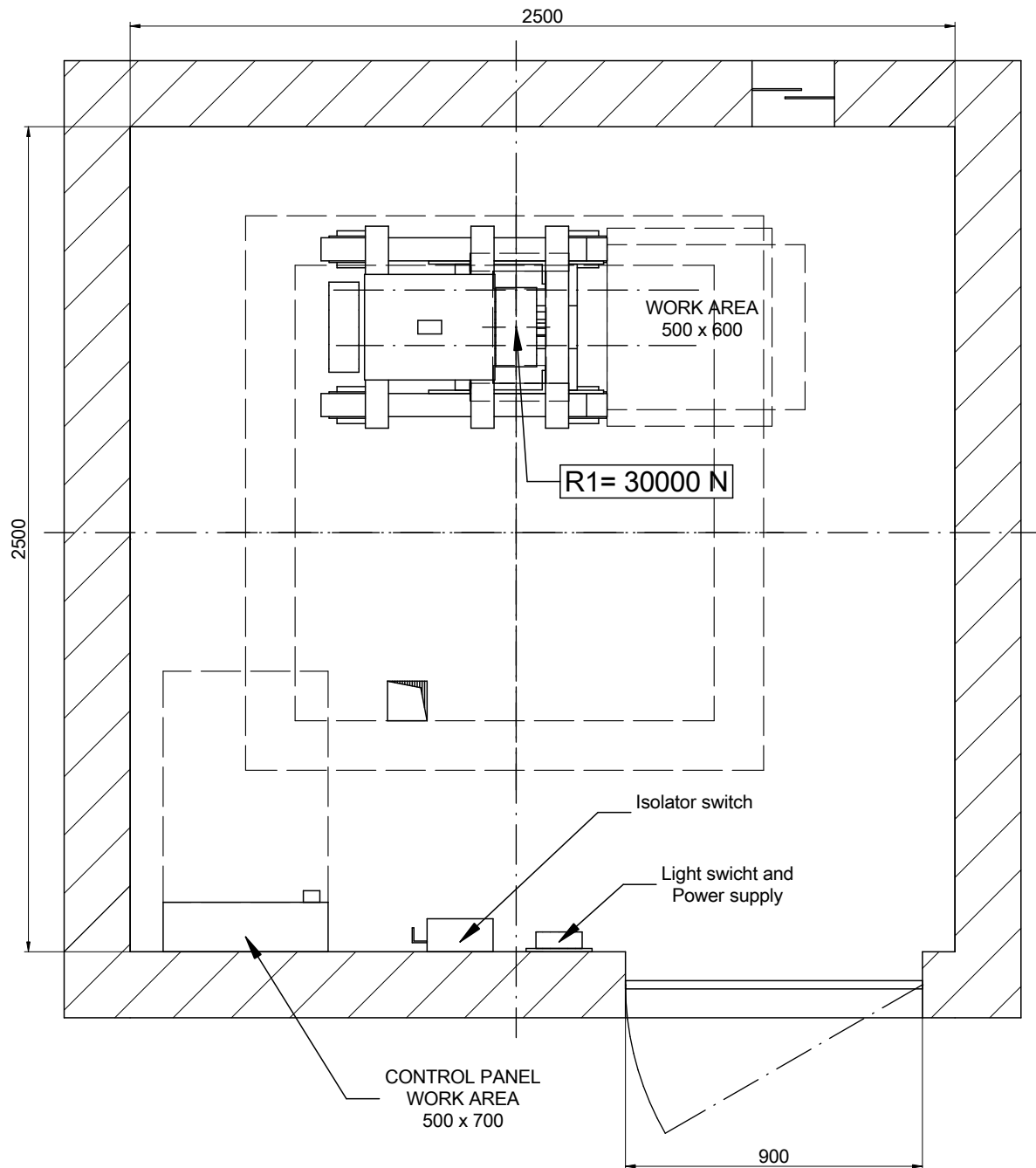

Minimum machine room height: 2100 mm.  
 [EN 81-20:2014 5.2.6.3.2.1]  
 Minimum clearance door: 600x2000 mm.  
 [EN 81-20:2014 5.2.3.2 a]

SCALE[\*]: 1:20

DRAWING	DATE	REV.	SHEET	[*] Unbounded dimensions in drawings are indicative and not binding.	
MP	2017	00	4/7	REFERENCE: MPGO!FLEXFONDO320C_EN	
MODEL LIFT:				CLIENT: WORK SITUATION:	<p style="text-align: center; font-size: 24px; font-weight: bold;">MP LIFTS</p>
<b>MP GO! FLEX</b>					
CAPACITY: [N° PERSONS]			4		
NOMINAL LOAD: [kg]			320		
SPEED: [m/s]			1		
FREQUENCY: [Hz]			50		
TENSION: [V]		380V [Three-phase]			

# 05-PIT LAYOUT

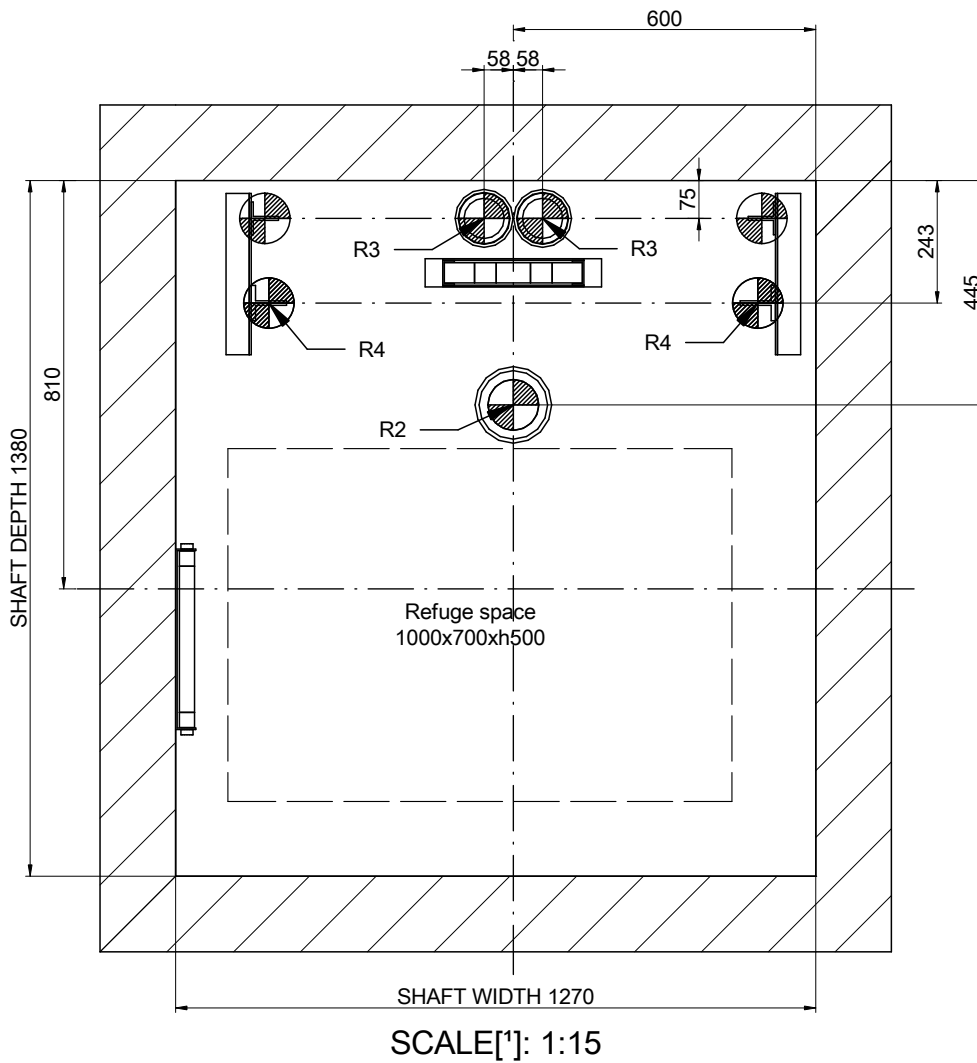

REACTIONS [N] [max.]			
R2	39600		
R3	16100	R4 12600	
Sx	2100	Sy 385	

DRAWING	DATE	REV.	SHEET	[*] Unbounded dimensions in drawings are indicative and not binding.	
MP	2017	00	5/7	REFERENCE: MPGO!FLEXFONDO320C_EN	
MODEL LIFT:				CLIENT:	<b>MP LIFTS</b>
<b>MP GO! FLEX</b>				WORK SITUATION:	
CAPACITY: [N° PERSONS]			4		
NOMINAL LOAD: [kg]			320		
SPEED: [m/s]			1		
FREQUENCY: [Hz]			50		
TENSION: [V]			380V [Three-phase]		

# 06-DOOR HOLE DETAIL

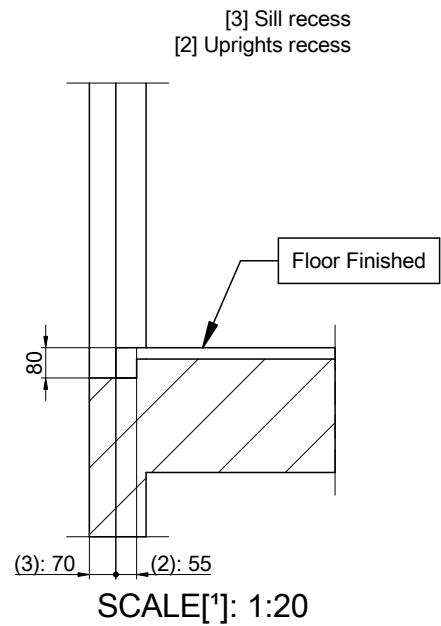
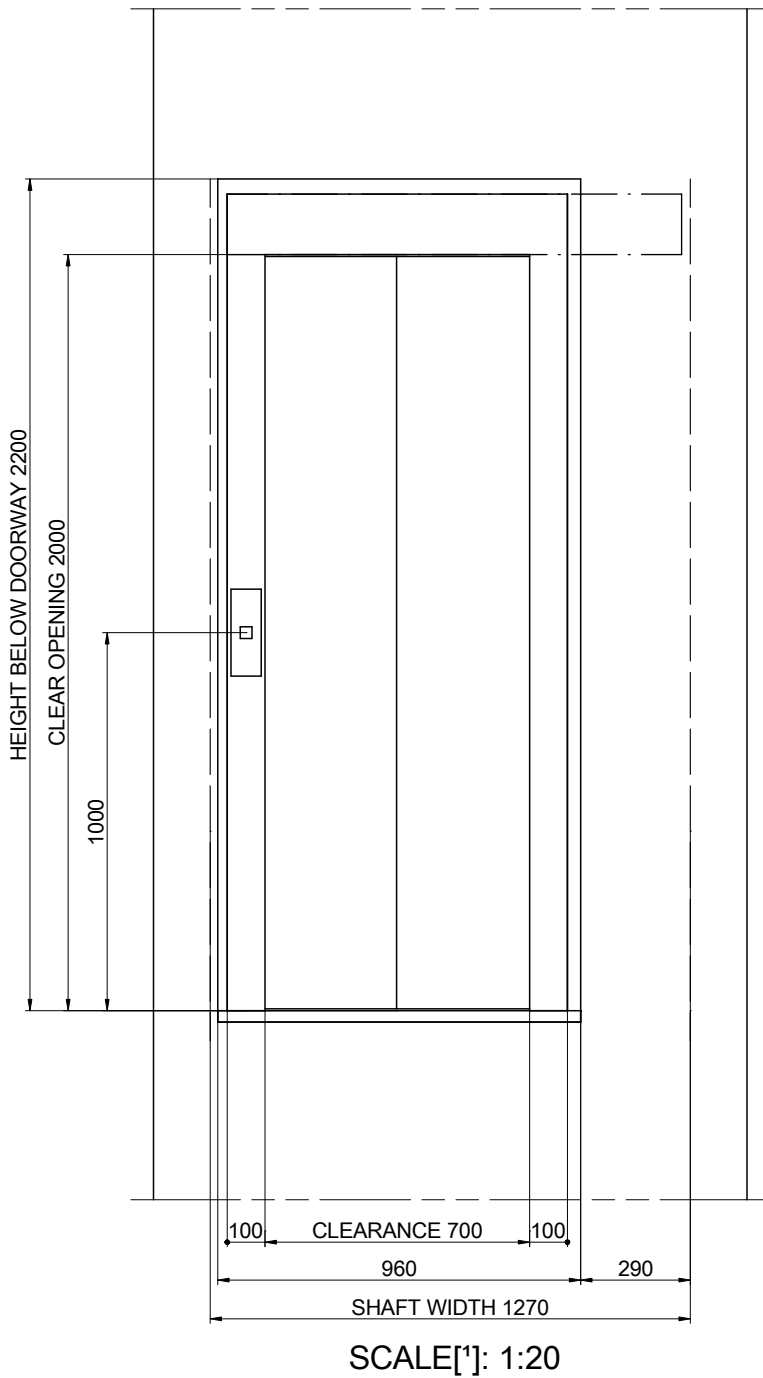

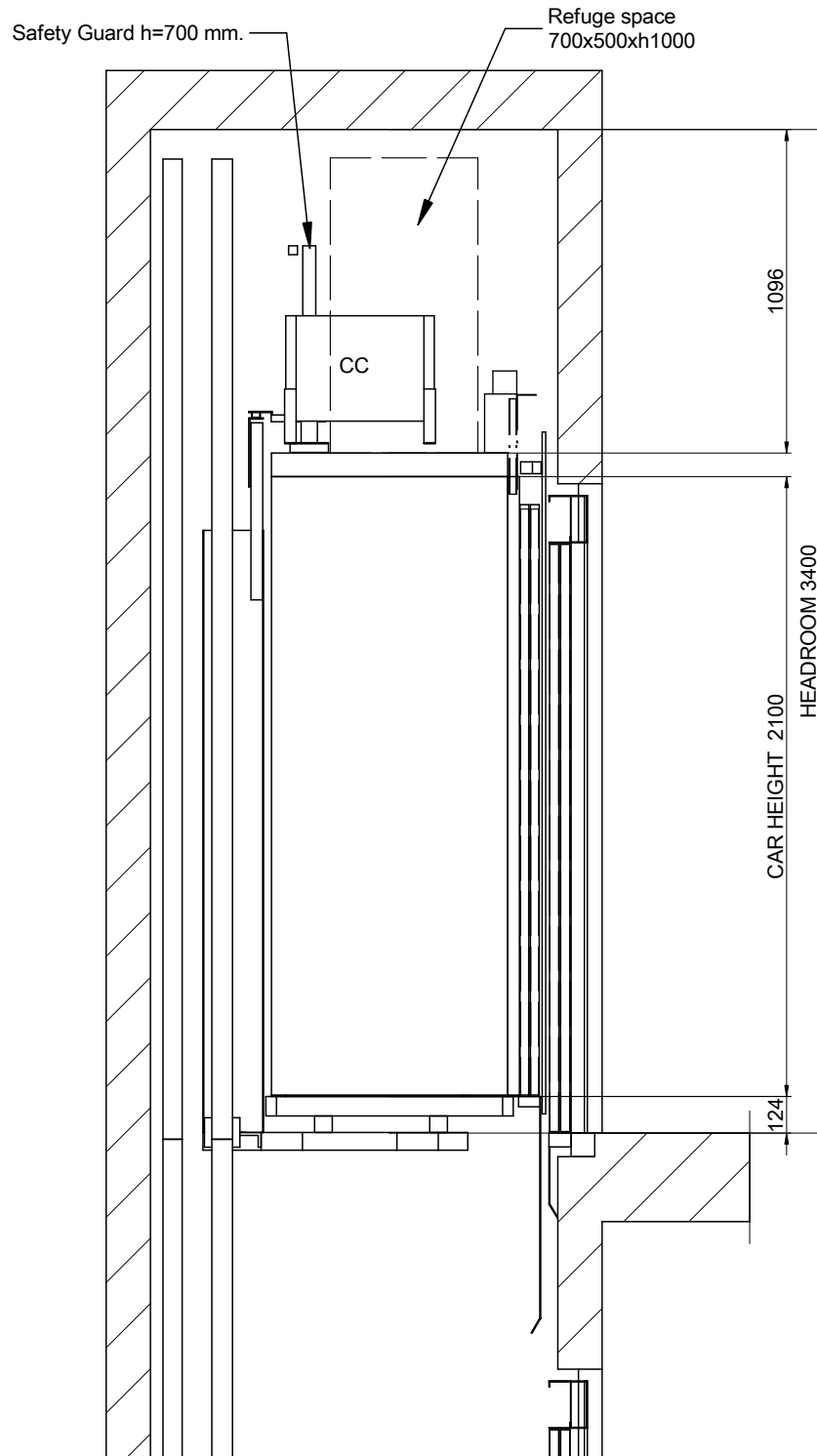

DRAWING	DATE	REV.	SHEET	[*] Unbounded dimensions in drawings are indicative and not binding. REFERENCE: MPGO!FLEXFONDO320C_EN	
MP	2017	00	6/7		
MODEL LIFT:				CLIENT:	WORK SITUATION:
MP GO! FLEX					
CAPACITY: [N° PERSONS]			4	<h2>MP LIFTS</h2>	
NOMINAL LOAD: [kg]			320		
SPEED: [m/s]			1		
FREQUENCY: [Hz]			50		
TENSION: [V]			380V [Three-phase]		

# 07-HEADROOM



SCALE[\*]: 1:25

DRAWING	DATE	REV.	SHEET	[*] Unbounded dimensions in drawings are indicative and not binding.		
MP	2017	00	7/7			
MODEL LIFT:				REFERENCE:		
<b>MP GO! FLEX</b>				MPGO!FLEXFONDO320C_EN		
CAPACITY: [N° PERSONS]				4		CLIENT:
NOMINAL LOAD: [kg]				320		WORK SITUATION:
SPEED: [m/s]				1		
FREQUENCY: [Hz]				50		
TENSION: [V]				380V [Three-phase]		<b>MP LIFTS</b>