

NOTE: It must be installed according to our recommendations indicated at the beginning of the New MP GO Assembly Manual "IMPORTANT ASPECTS" and the 2.12 chapter.

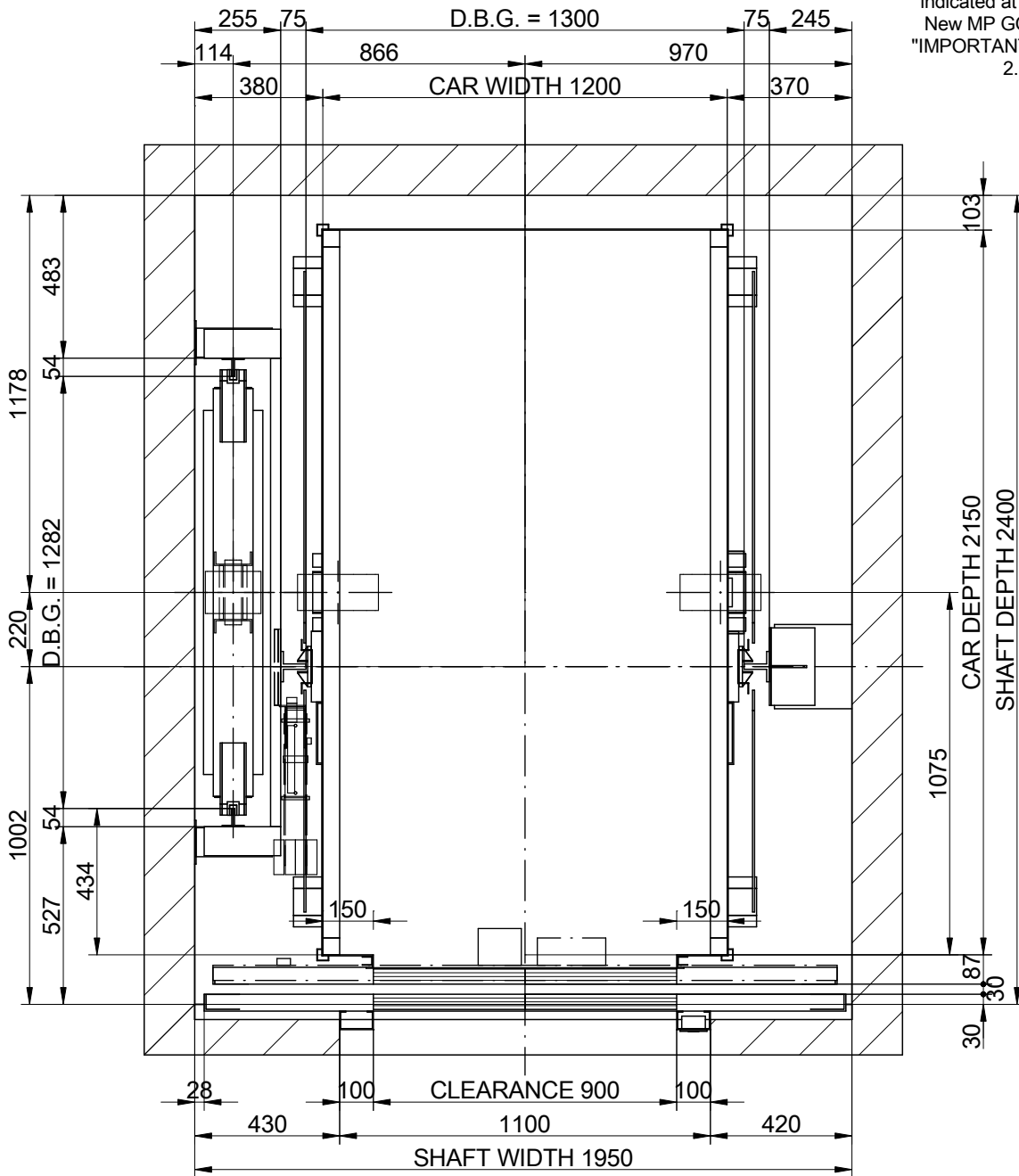

PLAN VIEW

SCALE(!): 1:20

F-1-602.rev.3

(!)Unbounded dimensions in drawings are indicative and not binding.

STOPS (N°) 6		REV. 0		
CAPACITY (N° PERSONS) 15		REFERENCE:		
NOMINAL LOAD (Kg.) 1125		.		
DATE	NAME	CLIENT:	TENSION (V.)	
2013	MP	WORK SITUATION:	FREQUENCY (Hz.)	
VERIFIED			0	
APPROV.				
MP		MODEL LIFT	SPEED (m/s)	
		MP1310GO!	1	

SIDE VERTICAL SECTION

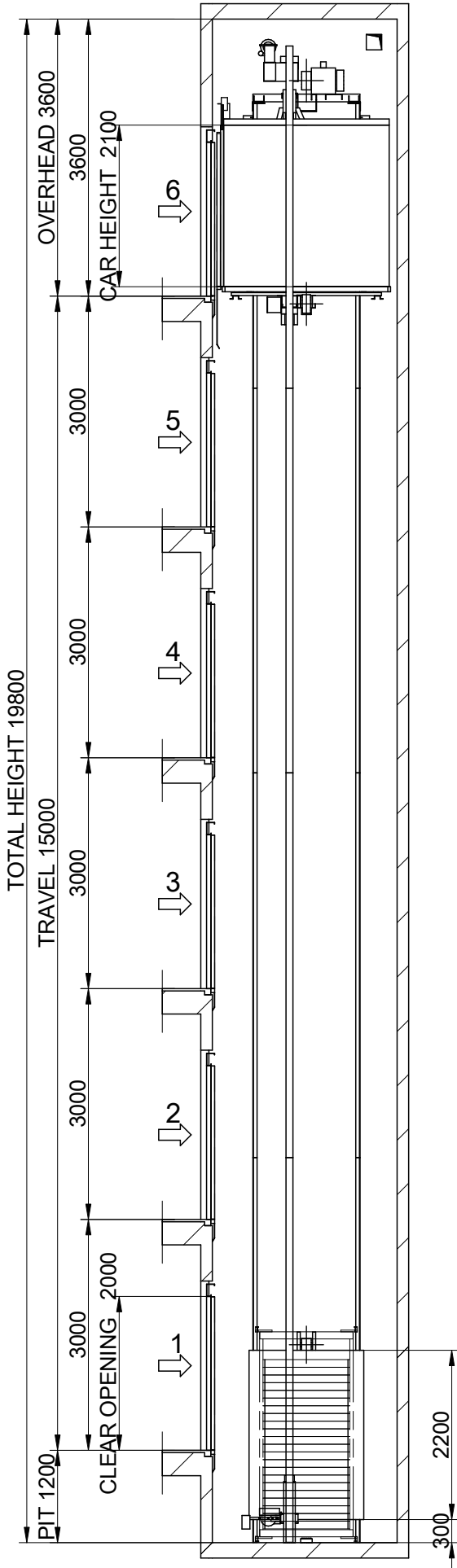

F-1-602.rev.3

(*!)Unbounded dimensions in drawings are indicative and not binding.



STOPS (N°)	6	REV. 0
CAPACITY (N° PERSONS)	15	REFERENCE:
NOMINAL LOAD (Kg.)	1125	.
DATE	NAME	TENSION (V.)
DRAWING	MP	FREQUENCY (Hz.)
VERIFIED		0
APPROV.		
	CLIENT:	
	WORK SITUATION:	
MP		MODEL LIFT
		MP1310GO!
		SPEED (m/s)
		1

- Flat and levelled floor, protected against water leaking. (EN81-1:98, 5.7.3.1)
- Foresee pit access device (EN81-1:98, 5.7.3.2)
- Stop device (EN81-1:98, 5.7.3.4)
- Power supply (EN81-1:98, 5.7.3.4)
- Light swicht commuted with the cabinet. (EN81-1:98, 5.7.3.4)
- Telephone jack (except Fonotec) (EN81-1:98, 5.10)

ELEVATION HOOKS ABLE TO SUPPORT
2000 Kg. EACH ONE SUPPLIED BY CONSTRUCTOR
(RECOMMENDED POSITION LOADHOOKS)

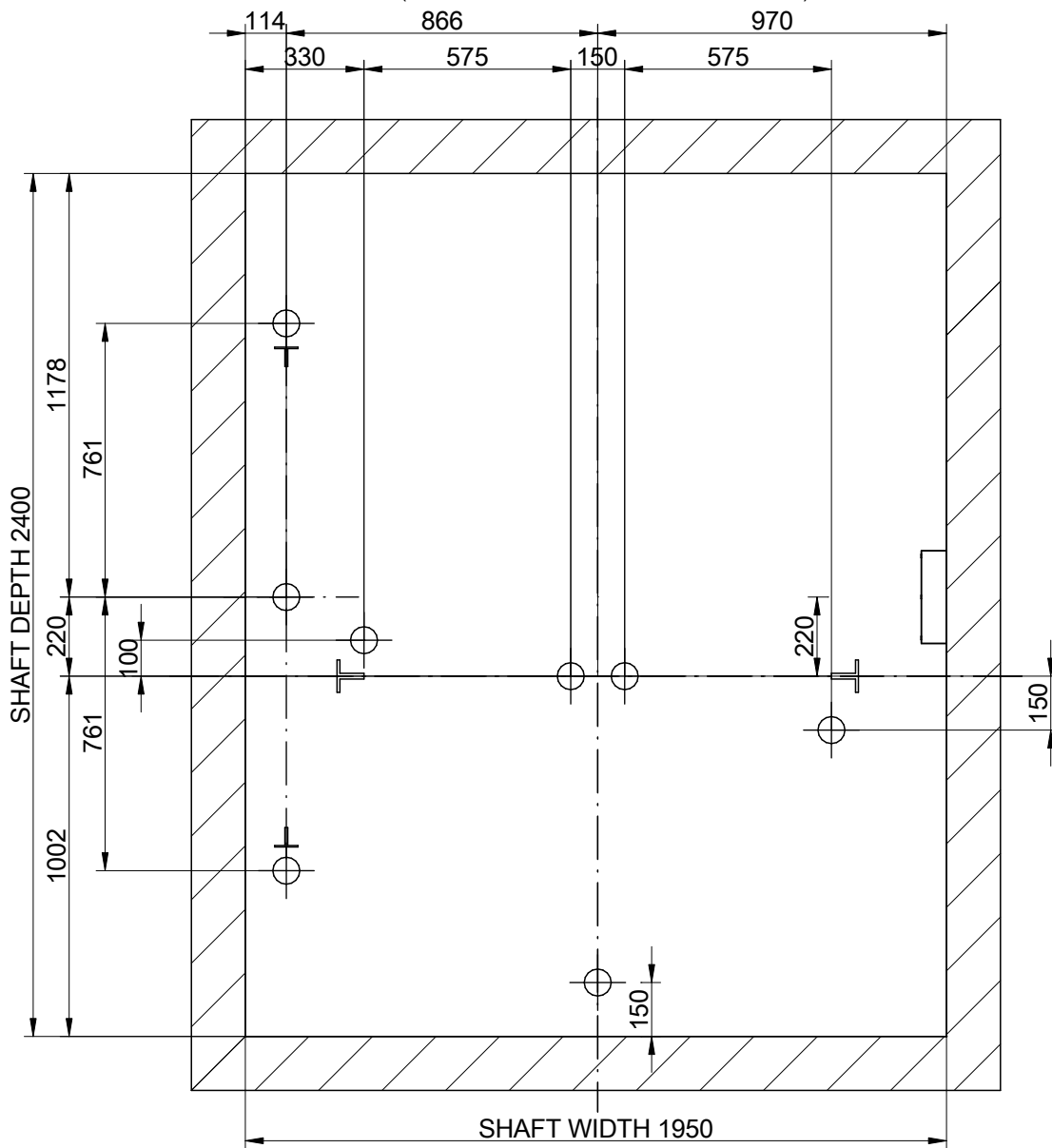

Ra=27400 N.

BEAM AND LIFTING HOOKS

SCALE(1): 1:20

F-1-602.rev.3

(*)Unbounded dimensions in drawings are indicative and not binding.

STOPS (N°) 6		REV. 0		
CAPACITY (N° PERSONS) 15		REFERENCE:		
NOMINAL LOAD (Kg.) 1125		.		
DATE	NAME	CLIENT:	TENSION (V.)	
DRAWING 2013	MP	WORK SITUATION:	FREQUENCY (Hz.)	
VERIFIED			0	
APPROV.				
MP		MODEL LIFT	SPEED (m/s)	
		MP1310GO!	1	

R1:31000 N
R2:25000 N
R2':25000 N
R3:88000 N
R4:66000 N
N:2800 N
T:1800 N

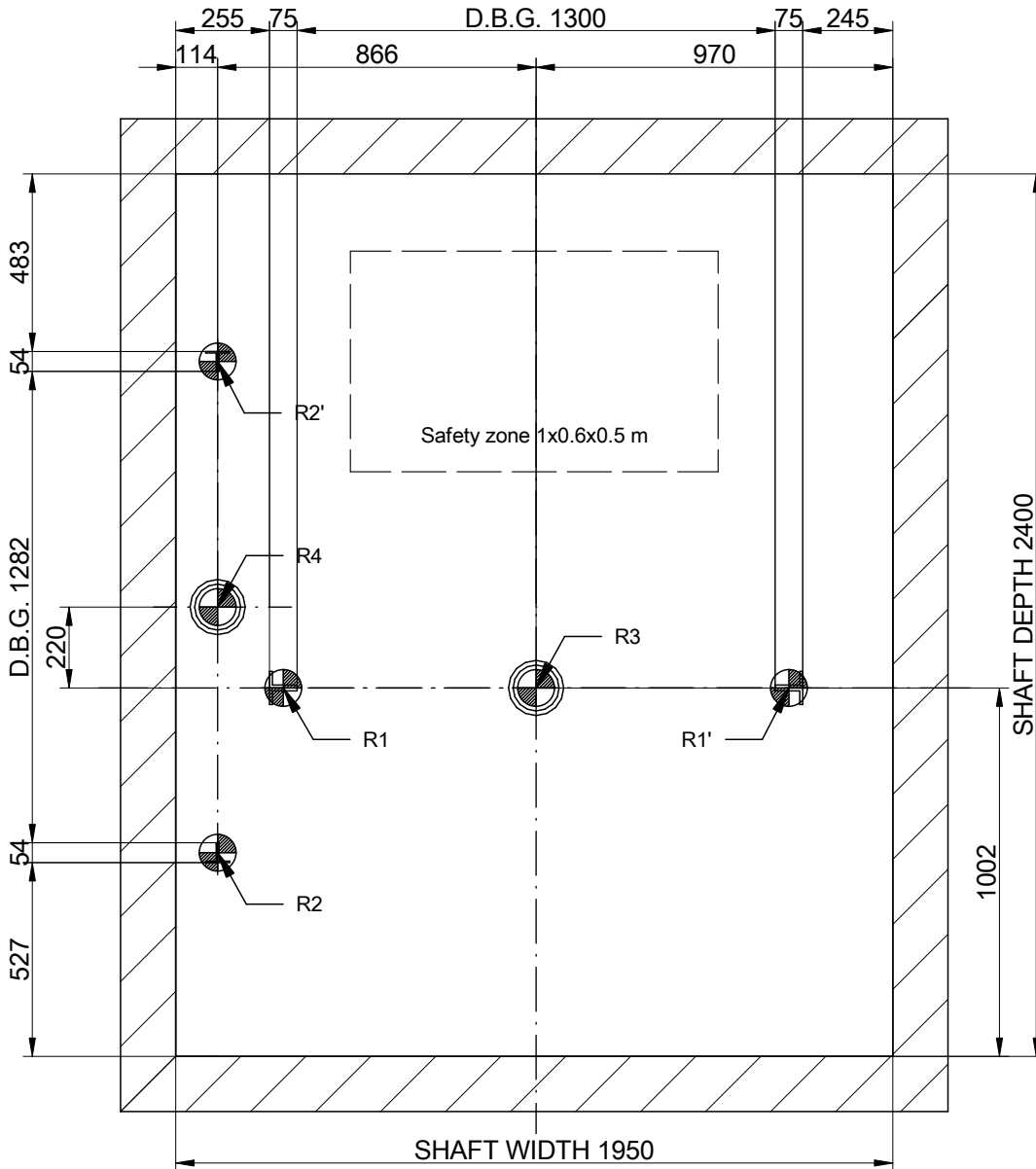

PIT LAYOUT
SCALE(*): 1:20

F-1-602.rev.3

(*Unbounded dimensions in drawings are indicative and not binding.

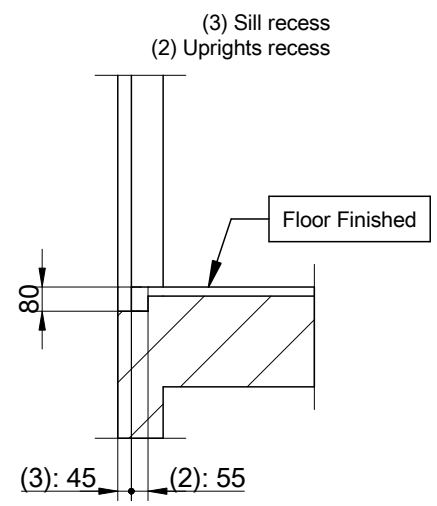
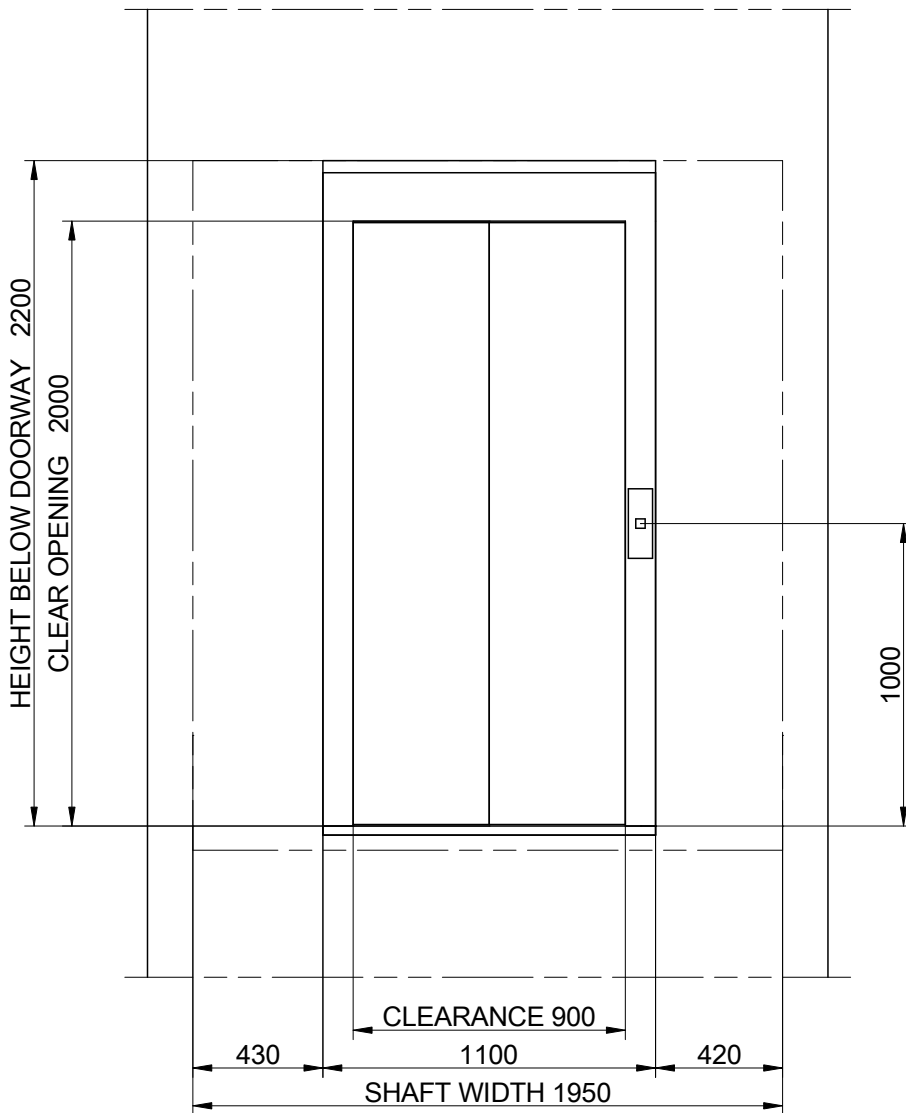

STOPS (N°) 6		REV. 0		
CAPACITY (N° PERSONS) 15		REFERENCE:		
NOMINAL LOAD (Kg.) 1125		.		
DATE	NAME	CLIENT:	TENSION (V.)	
DRAWING 2013	MP	WORK SITUATION:	FREQUENCY (Hz.)	
VERIFIED			0	
APPROV.				
MP		MODEL LIFT	SPEED (m/s)	
		MP1310GO!	1	



DOOR HOLE DETAIL
SCALE(1): 1:25

F-1-602.rev.3

(*)Unbounded dimensions in drawings are indicative and not binding.

STOPS (N°)		6	REV. 0		
CAPACITY (N° PERSONS)		15	REFERENCE:		
NOMINAL LOAD (Kg.)		1125	.		
	DATE	NAME	CLIENT:		TENSION (V.)
DRAWING	2013	MP	WORK SITUATION:		FREQUENCY (Hz.)
VERIFIED					0
APPROV.					
			MODEL LIFT	SPEED (m/s)	
			MP1310GO!	1	

WORK BY THE CUSTOMER

SHAFT: The structure of the shaft must be built according to the national building rules. Wall of the shaft must resist a pressure of 300 N in 5 cm² area, according EN81-1:98 5.3.1.1. Nominal dimensions according to the drawings.

Safety protections fitted. Floor levels signalled. The only use of the shaft must be for a lift installation. The recommended shaft ventilation is 1% of its transversal section (according to 5.2.3 EN81-1) The enclosure shall be imperforate, unless otherwise indicated. (EN81-1/2:98+A3:2009, 5.2.1.1)

CABINET: easy access, properly ventilated, with own lighting (or landing lighting) with 200 lux at the floor level, temperature between 5 °C and 40 °C. Non slippery and not dust generator floor.

CABINET ACCESS: properly illuminated. The access must be easy to use in any case, without necessity to go into private locals. The minimum crossing areas required by the rules of buildings must not be blocked for the lift or cabinet open doors.

ROOF SHAFT: suspensions hooks in the roof, prepared to resist the loads.

ELECTRIC SUPPLY: including statutory wiring up to the cabinet, with neutral, earth and lighting cables.

ELECTRICAL WIRING according to manuals.

LANDING ILLUMINATION: 50 lux at floor level.

EARTHING of all electric installation according to the statutory prescriptions in the harmonizing document CENELEC HD 384-5-54 S1.

PIT: flat and levelled pit floor, protected against water licking, able to resist loads according to drawings.

Permanent pit access device. When there are accessible areas placed under car or counterweight trajectory, the pit floor must be calculated for a 5000 N/m² minimum charge, and if the counterweight has not got a safety gear, a pillar that descend up to floor under counterweight buffer must be placed.

NOTE: The project carries out the application requisites of RD 1314/1997 (*). For eventual Rules of Local Buildings, Accessibility, Fire protection, ..., the client is responsible and he will have to control the fulfilment. The present drawing is developed by means of the facilitated information and it has caused the technical documents for the achievement of our products. Eventual MODIFICATIONS which affect their construction, will lead to the inspection of our order confirmation.

(*) For lifts in Spain "RD 1314/1997". 95/16/EC for lifts of the rest of Europe.

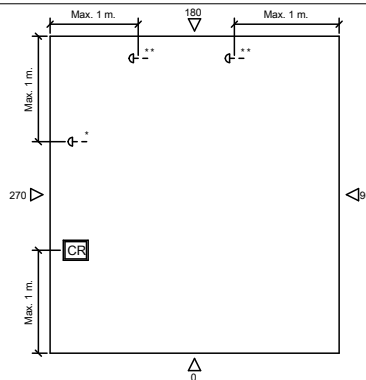

CAR ROOF SKETCH



- CR** Maintenance box.
- Q-** Additional STOP push button.
 - * Double landing 180° or separately work areas.
 - ** Double landing 90° or 270°

F-1-602.rev.1

DATE	NAME	MODIFICATIONS	REV.

STOPS (N°)	6	REV. 0	
CAPACITY (N° PERSONS)	15	REFERENCE:	
NOMINAL LOAD (Kg.)	1125	.	
DATE	NAME	CLIENT:	TENSION (V.)
DRAWING 2013	MP	WORK SITUATION:	FREQUENCY (Hz.)
VERIFIED			0
APPROV.			
		MODEL LIFT	SPEED (m/s)
		MP1310GO!	1